

# DRE

door catalogue

# 2024

1st edition



DRE doors Nestor 3  
cashmere matt

# DOOR PROMOTION

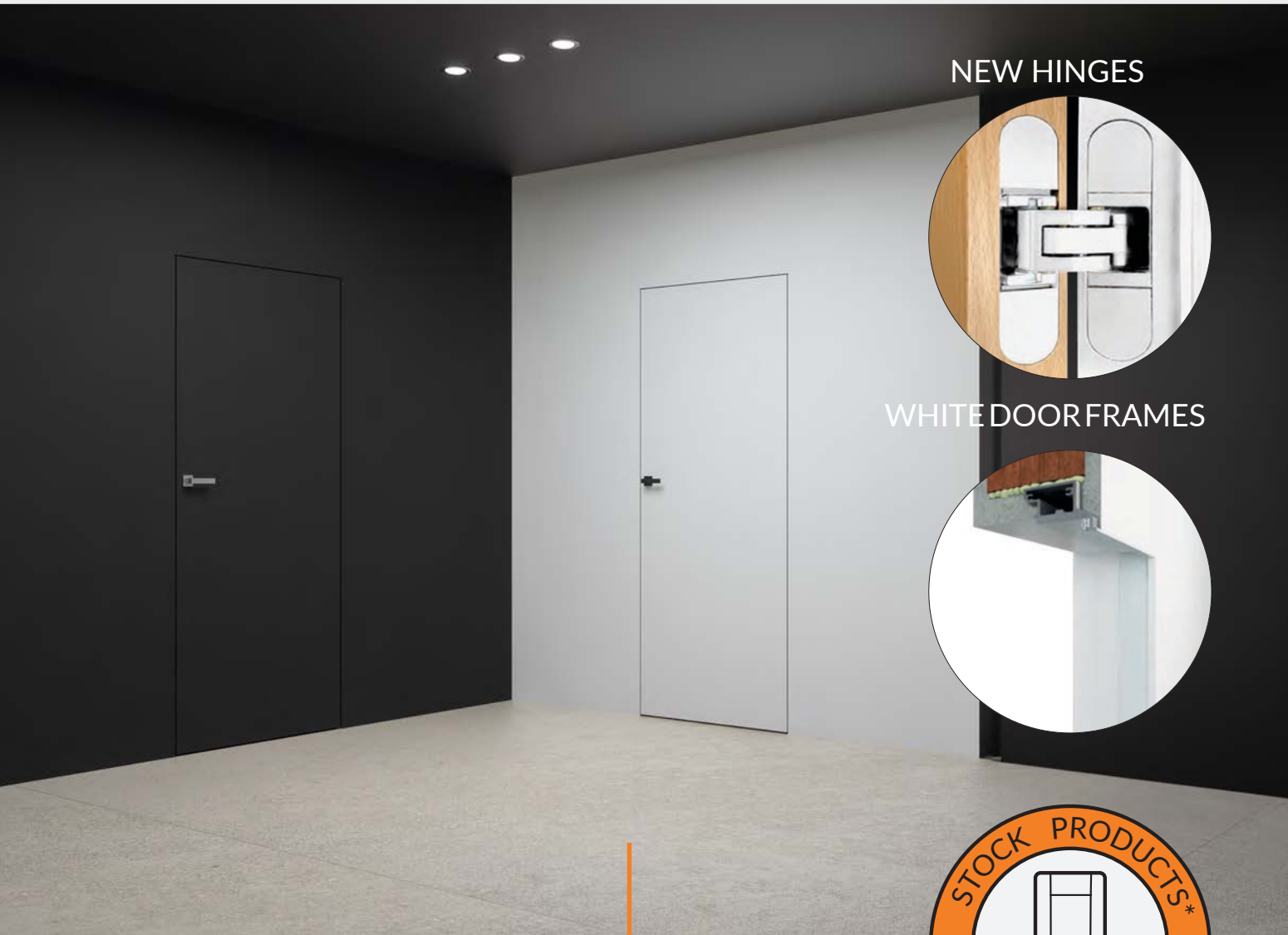

NEW HINGES



WHITE DOORFRAMES

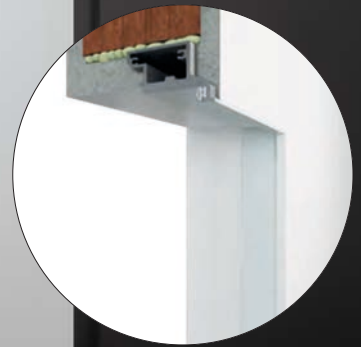

## SARA ECO 2



\*Sara ECO 2 doors with DRE aluminum door frames in aluminum and white colors are available from stock in selected configurations.

# TABLE OF CONTENTS

## FRAME CONSTRUCTION DOORS

<b>NEW</b>	Vetro E-Synchro.....	4
	Sigma.....	6
<b>NEW</b>	Estra.....	8
	Torino.....	10
	Verano.....	12
	Ena.....	13
	Triesta.....	14
	Solte.....	15
<b>NEW</b>	Reva.....	16
	Fosca.....	18
<b>NEW</b>	Nestor.....	20
<b>NEW</b>	Auri.....	22
	Elsa.....	24
	Premium.....	26
	Piano.....	28
	Scala.....	30
	Verso.....	32
	Vetro A.....	34
	Vetro B.....	36
	Vetro D.....	38
	Lumio.....	40
	Vico.....	42

## FRAME CONSTRUCTION DOORS PAINTED

	Berge.....	44
	Even.....	46
	Nestor.....	48
<b>NEW</b>	Vetro E.....	50

## PANEL CONSTRUCTION DOORS

<b>NEW</b>	Nova -Cell.....	52
	Wood.....	54
	Claro.....	56
	Grafi.....	58
	Lux.....	62
<b>NEW</b>	Nova -Synchro.....	64
	Rivia.....	66
	Galeria Alu.....	68
	Arte B.....	70
	Carla.....	71
	Finea and Finea B.....	72
	Deco.....	74
	Modern.....	76
	Kanon.....	78
	Plus.....	80
	Standard.....	82
	Fano.....	84
	Arte.....	86

## PANEL DOORS PAINTED

	UNI.....	88
	Fargo.....	90
	BINITO.....	92

## PANEL CONSTRUCTION DOORS CPL LAMINATE

	Standard Invest.....	94
	Standard CPL.....	96

## PANEL DOORS WITH VARIABLE HEIGHTS

	Standard 10.....	97
	Modern.....	98
	Plus.....	99

## SLIDING SYSTEM

	Wall mounted sliding system.....	100
	Glass doors sliding system.....	102
	wall-mounted sliding system SPAZIO CD.....	103

	Cassette tunnel cover PA.....	104
	door frameless cassette B01.....	106

## DOORS WITH HIDDEN DOOR FRAME

	Profi.....	107-108
<b>NEW</b>	SARA ECO 2.....	109
<b>NEW</b>	DRE aluminum door frames.....	111

## FOLDING DOORS

	Folde.....	112
--	------------	-----

## SIDE PANELS

	Panel construction.....	114
	Frame construction.....	115

## TRANSOM LIGHTS AND SIDELIGHTS

	TRANSOM LIGHTS AND SIDELIGHTS.....	116
--	------------------------------------	-----

## INTRIOR ENTRANCE PANEL CONSTRUCTION DOOR LEAVES

	Enter/Solid.....	118
	SOLID RC2.....	122

## TECHNICAL DOOR LEAVES

	Athos fire resistant doors . EI30.....	124
	FORCA anti-burglary door leaves RC3, fire resistant.....	126
	Forca B RC3 anti-burglary door leaves.....	127
	Olimp fire resistant doors. EI30, EI60.....	128
	Metal fire resistant door frame.....	130
<b>NEW</b>	Wooden fire resistant door frame.....	131

## DOOR LEAVES WITH SOUND INSULATION RATE

	Enter Acoustic Rw=32dB.....	132
--	-----------------------------	-----

## GLASS DOORS

	Galla.....	133
<b>NEW</b>	FITTINGS FOR GLASS DOORS.....	134
	Glass doors technical informations.....	135

## DOOR FRAMES

	fixed rebated door frames.....	136
	fixed non-rebated door frames.....	137
	Adjustable door frames.....	138-139
	Adjustable non-rebated door frames.....	140-141
	Rebated adjustable door frames with variable heights.....	142
	Adjustable non-rebated door frames with variable heights.....	143
	Adjustable door frames with inverted rebate.....	144
	Adjustable tunnel.....	145
	Adjustable non-rebated door frames with architrave panels.....	146
	Extension panels.....	148
	Metal fixed door frame.....	150
	Adjustable metal door frame.....	152
	adjustable metal door frame non-rebated.....	155
	Hybrid metal door frame.....	156
	Hybrid metal door frame non-rebated.....	158
	Small angular steel frames.....	159

## ACCESSORIES, ADDITIONAL INFORMATIONS

<b>NEW</b>	Door handles and accessories.....	160
	Decors.....	168
	graphic patterns in GRAFI collection.....	170
	Glass panes patterns.....	174
	Architraves and skirting boards.....	176
	Ventilation accessories and other.....	177
	Technical informations.....	178-186



VETRO E - natural halifax oak

EGGER 3 mm laminates 1st group

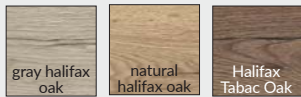

CLEAF 4 mm laminates 2nd group

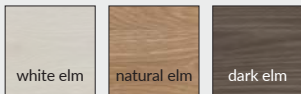

Horizontal cross-section of rebated VETRO E doors

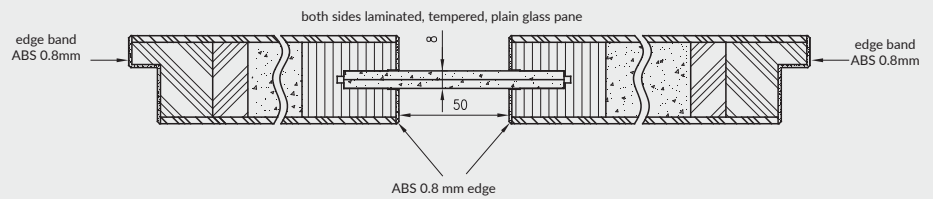

Horizontal cross-section of non-rebated VETRO E doors

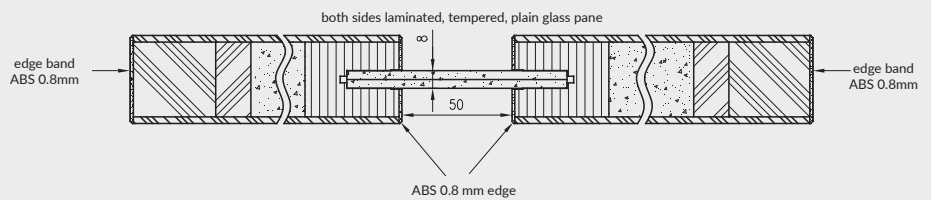

## STANDARD OPTIONS

- » door leaf surface is coated with laminated, synchronous 3 mm or 4 mm thick board
- » reinforced MDF frame
- » core made of tubular chipboard
- » DECORMAT tempered laminated 8 mm glass pane with fixed width (regardless the width of the door leaf) or laminated black tempered 8 mm glass pane (opaque) with fixed width (regardless the door leaf width)

## REBATED DOOR LEAF

- » straight edge in black **Fig. 1**
- » for natural halifax oak decor, the edge in the color of the door leaf or black
- » 3 silver screw-in pivot hinges
- » single-point mortise simple key lock, bathroom lock, cylinder lock or economic lock

## NON-REBATED DOOR LEAF (extra charge)

- » edge without rebate in black **Fig. 2**
- » for natural halifax oak decor, the edge in the color of the door leaf or black
- » sockets for 2 Estetic 80 recessed hinges in steel, black or white color (hinges constitute a part of the door frame)
- » magnetic simple key lock, bathroom lock, cylinder insert lock or economic lock in steel, black or white color

## DOOR FRAMES

- » for door leaves from the Vetro E collection in synchronous laminates, we recommend door frames in black matt foil 2 and in CPL laminate natural halifax oak in a longitudinal arrangement, in the second CPL price group

## OPTIONS AVAILABLE WITH EXTRA CHARGE

- » ventilation undercut
- » non-rebated door leaf

**NOTE:** third hinge Estetic 80 for non-rebated doors (extra charge is added to the price of the door frame)



## SLIDING DOOR LEAF

- » edge without rebate **fig. 2**
- » socket for hook lock and/or for handles

**NOTE:** sliding VETRO E door leaves do not fit the sliding system with the PA door frame cassette.

**NOTE:** There is no possibility to shorten door leaf.

VETRO E - meets ventilation requirements for widths "80" - "100" with ventilation undercut

**NOTE:** It is required to use together with VETRO rebated door leaf model door frames equipped with 3 hinges.



VETRO E  
gray halifax oak

VETRO E  
natural halifax oak

VETRO E  
Halifax Tabac Oak

VETRO E  
white elm

VETRO E  
natural elm

VETRO E  
dark elm



### SIGMA 4 - White

Laminated  
decor



### STANDARD OPTIONS

- » stiles made of wood-based panels
- » 4mm flat HDF panel black lacquered high gloss

### OPTIONS WITHOUT EXTRA CHARGE

- » T2 ventilation sleeves

### NON-REBATED OPENING DOOR LEAF

- » edge without rebate **fig.1**
- » sockets for two plate hinges (hinges constitute integral part of the door frame)
- » magnetic simple key lock, bathroom lock, cylinder lock or economic lock
- » ash color non-rebated edge for white decor, non-rebated edge in the same color as door leaf color for other decors
- » alternatively, black non-rebated edge for all decors
- » hinges and locks colors: black, white, steel
- » door leaf in white decor or bleached craft oak is available with Finish foil door frame in the same decor as the door leaf, door leaf in other decors is available with black matt 2 decor door frame.

### OPTIONS AVAILABLE WITH EXTRA CHARGE

- » door leaf „90” and „100”
- » ventilation undercut
- » cover strip for non-rebated double leaf door
- » double leaf door door leaf price x2
- » **NOTE: third plate hinge for non-rebated doors (extra charge is added to the price of the door frame)**

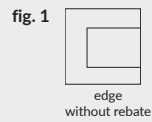

### plate hinge



SIGMA 1



SIGMA 2



SIGMA 3



SIGMA 4



ESTRA 13 - cashmere matt

	NEW							
DRE-Cell Decor	white matt	light gray matt	dark olive matt	dark blue matt	black matt 2	cashmere matt	warm gray matt	sage oak
3D Decor	grand oak	elm	walnut american	ebony*	Polish oak 3D			



## STANDARD OPTIONS

- » stiles made of wood-based panels
- » glass pane MAT DRE 4 mm thick
- » 16mm flat panels
- » Estra 7-9 models have black glass pane frame and black muntin frame
- » Estra 10 model with a mirror
- » Estra 12-14 models have a glazing bar in the color of the door leaf

## OPTIONS WITHOUT EXTRA CHARGE

- » glass pane DECORMAT BROWN, DECORMAT GRAPHITE and transparent glass pane
- » holes for ventilation sleeves

## REBATED DOOR LEAF

- » straight edge **fig. 1**
- » 3 silver screw-in pivot hinges
- » single-point mortise simple key lock, bathroom lock, cylinder lock or economic lock

## NON-REBATED OPENING DOOR LEAF (extra charge)

- » edge without rebate **fig. 2**
- » sockets for 2 recessed Estetic 80 hinges (hinges constitute a part of the door frame)
- » magnetic simple key lock, bathroom lock, cylinder lock or economic lock

## SLIDING DOOR LEAF

- » edge without rebate **fig. 2**
- » socket for hook lock and/or for handles

## DOOR LEAF WITH INVERTED REBATE (extra charge)

- » active single leaf door
- » straight edge **fig 3**
- » sockets for two recessed Estetic 1821 hinges (hinges constitute a part of the door frame)
- » magnetic simple key lock, bathroom lock, cylinder lock or economic lock

**NOTE:** This option is available only for matt foil decors

## OPTIONS AVAILABLE WITH EXTRA CHARGE

- » plastic ventilation sleeves 1 pc.
- » non-rebated door leaf
- » door leaf „90” and „100”
- » ventilation undercut
- » recuperative undercutting -15mm
- » door leaf with inverted rebate
- » cover strip for non-rebated double leaf door
- » double leaf door door leaf price x2

**NOTE:** third Estetic 80 hinge for non-rebated doors (extra charge is added to the price of the door frame)

**NOTE:** It is required to use door frame equipped with 3 hinges together with rebated door leaf ESTRA .

\* Note: Selected configurations of white matt rebated ESTRA 5 model are available in stock.

fig. 1



fixed edge

fig. 2



edge without rebate

fig. 3



edge with inverted rebate

Estra 10 door in the "obverse" variant

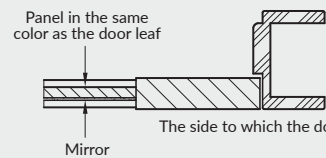

The side to which the door opens

Estra 10 door in the "reverse" variant

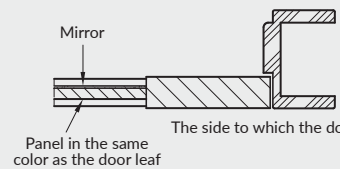

The side to which the door opens



ESTRA 1

ESTRA 2

ESTRA 3

ESTRA 4

ESTRA 5

ESTRA 6

ESTRA 7



ESTRA 8

ESTRA 9

ESTRA 10  
MIRROR

ESTRA 11

ESTRA 12

ESTRA 13

ESTRA 14



TORINO 1 - bleached craft oak

Laminated  
decor

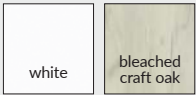

**STANDARD OPTIONS**

- » stiles made of wood-based panels
- » 4 mm MAT DRE glass pane or 4 mm HDF flat panel in black lacquered gloss
- » flat panel in the same color as the door leaf

**OPTIONS WITHOUT EXTRA CHARGE**

- » T2 ventilation sleeves

- REBATED DOOR LEAF**
- » straight edge **fig. 1**
  - » 3 silver screw-in hinges
  - » simple key lock, bathroom lock, cylinder lock or economic lock
  - » edge in the same color as the door leaf
  - » door leaves in white and bleached craft oak decors are available with the door frames covered with Finish foil in the same decor as the door leaf in the R-FINISH price group



**OPTIONS AVAILABLE WITH EXTRA CHARGE**

- » door leaf „90” and „100”
- » ventilation undercut
- » double leaf door door leaf price x2

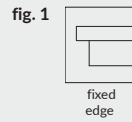

TORINO rebated door leaves must be used with 3 hinges door frames .



**TORINO 1**  
(4 panels in the same color as the door leaf)



**TORINO 2**  
(2 panels in the same color as the door leaf  
2 glass panes or panels lacquered black)



**TORINO 3**  
(4 glass panes or panels lacquered black)



**TORINO 4**  
(1 panel in the same color as the door leaf  
3 glass panes or panels lacquered black)

## STANDARD OPTIONS

- » stiles made of wood-based panels
- » glass pane MAT DRE 4 mm thick

## OPTIONS WITHOUT EXTRA CHARGE

- » glass pane DECORMAT BROWN, DECORMAT GRAPHITE and transparent glass pane
- » holes for ventilation sleeves

## OPTIONS AVAILABLE WITH EXTRA CHARGE

- » plastic ventilation sleeves 1 pc.
- » non-rebated door leaf
- » door leaf „90” and „100”
- » ventilation undercut
- » recuperative undercutting -15mm
- » cover strip for non-rebated double leaf door
- » double leaf door door leaf price x2
- » **NOTE:** third Estetic 80 hinge for non-rebated doors (extra charge is added to the price of the door frame)

## REBATED DOOR LEAF

- » straight edge **fig. 1**
- » 3 silver screw-in pivot hinges
- » single-point mortise simple key lock, bathroom lock, cylinder lock or economic lock

## NON-REBATED DOOR LEAF (EXTRA CHARGE)

- » edge without rebate **fig. 2**
- » sockets for 2 recessed Estetic 80 hinges (hinges constitute a part of the door frame)
- » magnetic simple key lock, bathroom lock, cylinder lock or economic lock

## SLIDING DOOR LEAF

- » edge without rebate **fig. 2**
- » socket for hook lock and/or for handles

**NOTE:** It is required to use door frame equipped with 3 hinges together with VERANO rebated door leaf model .

fig. 1



fig. 2



### DRE-Cell Decor



### STANDARD OPTIONS

- » stiles made of wood-based panels
- » glass pane MAT DRE 4 mm thick

### OPTIONS WITHOUT EXTRA CHARGE

- » glass pane DECORMAT BROWN, DECORMAT GRAPHITE and transparent glass pane
- » holes for ventilation sleeves

### OPTIONS AVAILABLE WITH EXTRA CHARGE

- » plastic ventilation sleeves 1 pc.
- » non-rebated door leaf
- » door leaf „90” and „100”
- » ventilation undercut
- » recuperative undercutting -15mm
- » cover strip for non-rebated double leaf door
- » double leaf door door leaf price x2
- » **NOTE:** third Estetic 80 hinge for non-rebated doors (extra charge is added to the price of the door frame)

### REBATED DOOR LEAF

- » straight edge **fig. 1**
- » 3 silver screw-in pivot hinges
- » single-point mortise simple key lock, bathroom lock, cylinder lock or economic lock

### NON-REBATED DOOR LEAF (EXTRA CHARGE)

- » edge without rebate **fig. 2**
- » sockets for 2 recessed Estetic 80 hinges (hinges constitute a part of the door frame)
- » magnetic simple key lock, bathroom lock, cylinder lock or economic lock

### SLIDING DOOR LEAF

- » edge without rebate **fig. 2**
- » socket for hook lock and/or for handles

fig. 1

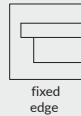
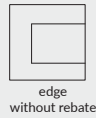

fig. 2



## STANDARD OPTIONS

- » stiles made of wood-based panels
- » glass pane MAT DRE 4 mm thick

## OPTIONS WITHOUT EXTRA CHARGE

- » glass pane DECORMAT BROWN, DECORMAT GRAPHITE and transparent glass pane
- » holes for ventilation sleeves

## OPTIONS AVAILABLE WITH EXTRA CHARGE

- » plastic ventilation sleeves 1 pc.
- » non-rebated door leaf
- » door leaf „90” and „100”
- » ventilation undercut
- » recuperative undercutting -15mm
- » cover strip for non-rebated double leaf door
- » double leaf door door leaf price x2
- » **NOTE:** third Estetic 80 hinge for non-rebated doors (extra charge is added to the price of the door frame)

## REBATED DOOR LEAF

- » straight edge **fig. 1**
- » 3 silver screw-in pivot hinges
- » single-point mortise simple key lock, bathroom lock, cylinder lock or economic lock

## NON-REBATED DOOR LEAF (EXTRA CHARGE)

- » edge without rebate **fig. 2**
- » sockets for 2 recessed Estetic 80 hinges (hinges constitute a part of the door frame)
- » magnetic simple key lock, bathroom lock, cylinder lock or economic lock

## SLIDING DOOR LEAF

- » edge without rebate **fig. 2**
- » socket for hook lock and/or for handles

**NOTE:** It is required to use door frame with 3 hinges together with TRIESTA rebated door leaf model. The left door is a mirror image of the right door.

fig. 1



fixed edge

fig. 2



edge without rebate



TRIESTA 0



TRIESTA 1



TRIESTA 2



TRIESTA 3

DRE-Cell  
Decor



**STANDARD OPTIONS**

- » stiles made of wood-based panels
- » glass pane MAT DRE 4 mm thick (SOLTE 2 - 3)
- » flat panel insert (SOLTE 1 - 2)

**OPTIONS WITHOUT EXTRA CHARGE**

- » glass pane DECORMAT BROWN, DECORMAT GRAPHITE and transparent glass pane
- » holes for ventilation sleeves

**OPTIONS AVAILABLE WITH EXTRA CHARGE**

- » plastic ventilation sleeves 1 pc.
- » non-rebated door leaf
- » door leaf „90” and „100”
- » ventilation undercut
- » recuperative undercutting -15mm
- » cover strip for non-rebated double leaf door
- » double leaf door door leaf price x2
- » **NOTE:** third Estetic 80 hinge for non-rebated doors (extra charge is added to the price of the door frame)

**REBATED DOOR LEAF**

- » straight edge **fig. 1**
- » 3 silver screw-in pivot hinges
- » single-point mortise simple key lock, bathroom lock, cylinder lock or economic lock

fig. 1

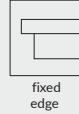

**NON-REBATED DOOR LEAF (EXTRA CHARGE)**

- » edge without rebate **fig. 2**
- » sockets for 2 recessed Estetic 80 hinges (hinges constitute a part of the door frame)
- » magnetic simple key lock, bathroom lock, cylinder lock or economic lock

fig. 2

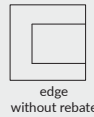

SOLTE panel - 4 mm thick

**SLIDING DOOR LEAF**

- » edge without rebate **fig. 2**
- » socket for hook lock and/or for handles

**NOTE:** Rebated "40" side panels available.

**NOTE:** It is required to use door frame equipped with 3 hinges together with SOLTE rebated door leaf model.



SOLTE 1

SOLTE 2

SOLTE 3





REVA 1 - white pine

DRE-Cell Decor 1st gr.	white (textured)	white matt	white pine	siberian elm	sand oak	bleached oak textured	vintage oak	
	anthracite elm	dark wenge	marrone chestnut textured	black matt 2	evoke oak	caramel walnut	golden oak textured	
3D Decor	grand oak	elm	walnut american	ebony*	Polish oak 3D	<i>*while stock last</i>		
DRE-Cell Decor 2nd gr.	light gray matt	dark olive matt	dark blue matt	cashmere matt	warm gray matt	sage oak		
<b>NEW</b>								



### STANDARD OPTIONS

- » stiles made of wood-based panels
- » glass pane MAT DRE 4 mm thick
- » flat inserts (REVA 5-7)

### OPTIONS WITHOUT EXTRA CHARGE

- » glass pane DECORMAT BROWN, DECORMAT GRAPHITE and transparent glass pane
- » holes for ventilation sleeves

### REBATED DOOR LEAF

- » straight edge **fig. 1**
- » 3 silver screw-in pivot hinges
- » single-point mortise simple key lock, bathroom lock, cylinder lock or economic lock

### NON-REBATED DOOR LEAF (EXTRA CHARGE)

- » edge without rebate **fig. 2**
- » sockets for 2 recessed Estetic 80 hinges (hinges constitute a part of the door frame)
- » magnetic simple key lock, bathroom lock, cylinder lock or economic lock

### SLIDING DOOR LEAF

- » edge without rebate **fig. 2**
- » socket for hook lock and/or for handles

NOTE: Rebated "40" side panels available.

NOTE: It is required to use door frame equipped with 3 hinges together with REVA rebated door leaf model.

### OPTIONS AVAILABLE WITH EXTRA CHARGE

- » plastic ventilation sleeves 1 pc.
- » non-rebated door leaf
- » door leaf „90" and „100"
- » ventilation undercut
- » recuperative undercutting -15mm
- » cover strip for non-rebated double leaf door
- » black VSG 22.1 safe, complex glass pane REVA 1  
REVA 2  
REVA 3.4  
REVA 5  
REVA 7
- » double leaf door door leaf price x2
- » NOTE: third Estetic 80 hinge for non-rebated doors (extra charge is added to the price of the door frame)

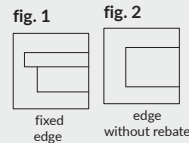



FOSCA 0 - grand oak

DRE-Cell  
Decor

white (textured)	white matt	white pine	siberian elm	sand oak	bleached oak textured	vintage oak	caramel walnut
anthracite elm	dark wenge	marrone chestnut textured	black matt 2	light gray matt	evoke oak	golden oak textured	

3D Decor

grand oak	elm	walnut american	ebony*	Polish oak 3D	<i>*while stock last</i>	
-----------	-----	--------------------	--------	------------------	--------------------------	--

### STANDARD OPTIONS

- » stiles made of wood-based panels
- » glass pane MAT DRE 4 mm thick
- » flat panel insert coated with silver laminate (FOSCA 1-3) or in door leaf colour (FOSCA 4-6)

### OPTION WITHOUT EXTRA CHARGE

- » glass pane DECORMAT BROWN, DECORMAT GRAPHITE and transparent glass pane
- » holes for ventilation sleeves

### OPTIONS AVAILABLE WITH EXTRA CHARGE

- » plastic ventilation sleeves 1 pc.
- » non-rebated door leaf
- » door leaf „90” and „100”
- » ventilation undercut
- » recuperative undercutting -15mm
- » cover strip for non-rebated double leaf door
- » double leaf door door leaf price x2
- » **NOTE:** third Estetic 80 hinge for non-rebated doors (extra charge is added to the price of the door frame)

### REBATED DOOR LEAF

- » straight edge **fig. 1**
- » 3 silver screw-in pivot hinges
- » single-point mortise simple key lock, bathroom lock, cylinder lock or economic lock

### NON-REBATED DOOR LEAF (EXTRA CHARGE)

- » edge without rebate **fig. 2**
- » sockets for 2 recessed Estetic 80 hinges (hinges constitute a part of the door frame)
- » magnetic simple key lock, bathroom lock, cylinder lock or economic lock

### SLIDING SYSTEM DOOR LEAF

- » edge without rebate **fig. 2**
- » socket for hook lock and/or for handles

**NOTE:** There is possibility to make rebated „40” side panels.

**NOTE:** It is required to use door frame equipped with 3 hinges together with FOSCA rebated door leaf model.

fig. 1

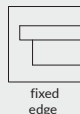
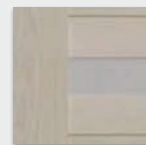
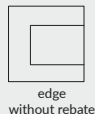
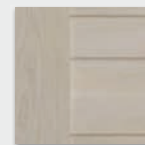

fig. 2



FOSCA 1-3  
(4mm HDF insert coated with silver laminate)



FOSCA 4-6  
(4mm HDF insert coated in door leaf colour)



FOSCA 0  
(5 glass panes)

FOSCA 1  
(3 glass panes, 2 HDF panels)

FOSCA 2  
(1 glass pane, 4 HDF panels)

FOSCA 3  
(5 HDF panels)

FOSCA 4  
(3 glass panes, 2 HDF panels)

FOSCA 5  
(1 glass pane, 4 HDF panels)

FOSCA 6  
(5 HDF panels)



NESTOR 1 - black matt 2

	NEW							
DRE-Cell Decor	white matt	light gray matt	dark olive matt	dark blue matt	black matt 2	cashmere matt	warm gray matt	sage oak
	white pine	sand oak	vintage oak	anthracite elm	dark wenge	siberian elm	caramel walnut	
3D Decor	Polish oak 3D							

**DOOR HANDLE WITH A BACKPLATE**

The promotion applies to rebated and non-rebated door leaves from NESTOR collection in DRE-Cell Decor and 3D foil. Door handle model and finishing colors to choose from: WEGA, ATRIA, ARCTUS, POLARIS and ORION door handles and a backplate with a simple key or cylinder or a bathroom lock. The promotion lasts while stocks last.



## STANDARD OPTIONS

- » stiles made of wood-based panels
- » glass pane MAT DRE 4 mm thick
- » profiled 19mm MDF panels

## OPTIONS WITHOUT EXTRA CHARGE

- » glass pane DECORMAT BROWN, DECORMAT GRAPHITE and transparent glass pane
- » holes for ventilation sleeves

## REBATED DOOR LEAF

- » straight edge **fig. 1**
- » 3 silver screw-in pivot hinges
- » single-point mortise simple key lock, bathroom lock, cylinder lock or economic lock

## NON-REBATED DOOR LEAF (EXTRA CHARGE)

- » edge without rebate **fig. 2**
- » sockets for 2 recessed Estetic 80 hinges (hinges constitute a part of the door frame)
- » magnetic simple key lock, bathroom lock, cylinder lock or economic lock

## SLIDING DOOR LEAF

- » edge without rebate **fig. 2**
- » socket for hook lock and/or for handles

## DOOR LEAF WITH INVERTED REBATE (extra charge)

- » active single leaf door
- » straight edge **fig 3**
- » sockets for two recessed Estetic 1821 hinges (hinges constitute a part of the door frame)
- » magnetic simple key lock, bathroom lock, cylinder lock or economic lock

**NOTE:** This option is available only for matt foil decors

## OPTIONS AVAILABLE WITH EXTRA CHARGE

- » plastic ventilation sleeves 1 pc.
- » non-rebated door leaf
- » door leaf „90” and „100”
- » ventilation undercut
- » recuperative undercutting -15mm
- » door leaf with inverted rebate
- » cover strip for non-rebated double leaf door
- » double leaf door door leaf price x2

**NOTE:** third Estetic 80 hinge for non-rebated doors (extra charge is added to the price of the door frame)

**NOTE:** It is required to use together with NESTOR rebated door leaf model door frames equipped with 3 hinges.

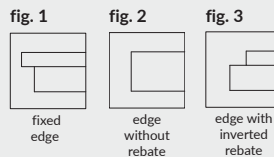



AURI 8 - American walnut

DRE-Cell Decor 1st gr.	white (textured)	white matt	white pine	siberian elm	sand oak	bleached oak textured	vintage oak
	anthracite elm	dark wenge	marrone chestnut textured	black matt 2	evoke oak	caramel walnut	golden oak textured
3D Decor	grand oak	elm	walnut american	ebony*	Polish oak 3D	<i>*while stock last</i>	
	DRE-Cell Decor 2nd gr.	light gray matt	dark olive matt	dark blue matt	cashmere matt	warm gray matt	sage oak
<b>NEW</b>							

### STANDARD OPTIONS

- » stiles made of wood-based panels
- » glass pane MAT DRE 4 mm thick
- » flat inserts (AURI 6-8)

### OPTIONS WITHOUT EXTRA CHARGE

- » glass pane DECORMAT BROWN, DECORMAT GRAPHITE and transparent glass pane
- » holes for ventilation sleeves

### REBATED DOOR LEAF

- » straight edge **fig. 1**
- » 3 silver screw-in pivot hinges
- » single-point mortise simple key lock, bathroom lock, cylinder lock or economic lock

### NON-REBATED DOOR LEAF (EXTRA CHARGE)

- » edge without rebate **fig. 2**
- » sockets for 2 recessed Estetic 80 hinges (hinges constitute a part of the door frame)
- » magnetic simple key lock, bathroom lock, cylinder lock or economic lock

### SLIDING DOOR LEAF

- » edge without rebate **fig. 2**
- » socket for hook lock and/or for handles

**NOTE:** Rebated "40" side panels available.

It is required to use door frame equipped with 3 hinges together with AURI rebated door leaf model.

### OPTIONS AVAILABLE WITH EXTRA CHARGE

- » plastic ventilation sleeves 1 pc.
- » non-rebated door leaf
- » door leaf „90" and „100"
- » ventilation undercut
- » recuperative undercutting -15mm
- » cover strip for non-rebated double leaf door
- » black VSG 22.1 safe, complex glass pane AURI 0  
AURI 1  
AURI 2, 5  
AURI 3  
AURI 4  
AURI 6  
AURI 8  
double leaf door door leaf price x2
- » **NOTE:** third Estetic 80 hinge for non-rebated doors (extra charge is added to the price of the door frame)

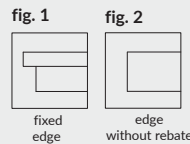



ELSA A3 and ELSA 0 - sand oak

DRE-Cell Decor						
	white matt	white pine	sand oak	vintage oak	anthracite elm	dark wenge
3D Decor						
	Polish oak 3D					

**DOOR HANDLE WITH A BACKPLATE**

The promotion applies to rebated and non-rebated door leaves from ELSA collection in DRE-Cell Decor and 3D foil. Door handle model and finishing colors to choose from: WEGA, ATRIA, ARCTUS, POLARIS and ORION door handles and a backplate with a simple key or cylinder or a bathroom lock. The promotion lasts while stocks last.





### STANDARD OPTIONS

- » stiles made of wood-based panels
- » glass pane MAT DRE 4 mm thick
- » flat panel insert (ELSA A), profiled 19 mm MDF panels (ELSA B)

### OPTIONS WITHOUT EXTRA CHARGE

- » glass pane DECORMAT BROWN, DECORMAT GRAPHITE and transparent glass pane
- » holes for ventilation sleeves

### OPTIONS AVAILABLE WITH EXTRA CHARGE

- » plastic ventilation sleeves 1 pc.
- » non-rebated door leaf
- » door leaf „90” and „100”
- » ventilation undercut
- » recuperative undercutting -15mm
- » cover strip for non-rebated double leaf door
- » double leaf door door leaf price x2
- » **NOTE:** third Estetic 80 hinge for non-rebated doors (extra charge is added to the price of the door frame)

### REBATED DOOR LEAF

- » straight edge **fig. 1**
- » 3 silver screw-in pivot hinges
- » single-point mortise simple key lock, bathroom lock, cylinder lock or economic lock

### NON-REBATED DOOR LEAF (EXTRA CHARGE)

- » edge without rebate **fig. 2**
- » sockets for 2 recessed Estetic 80 hinges (hinges constitute a part of the door frame)
- » magnetic simple key lock, bathroom lock, cylinder lock or economic lock

### SLIDING DOOR LEAF

- » edge without rebate **fig. 2**
- » socket for hook lock and/or for handles

**NOTE:** Rebated "40" side panels available.

It is required to use door frame equipped with 3 hinges together with ELSA rebated door leaf model.

ELSA collection is divided into A and B:  
A - flat panel insert in door leaf colour  
B - 19 mm convex panel insert in door leaf colour

fig. 1

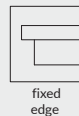

fixed edge

fig. 2

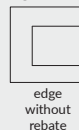

edge without rebate



cross-section of ELSA A



cross-section of ELSA B



ELSA A



ELSA A1



ELSA A2



ELSA A3

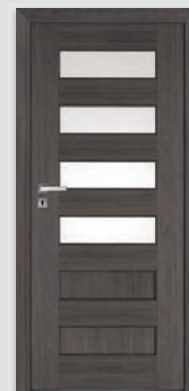

ELSA A4



ELSA B5



ELSA B6



ELSA B7



ELSA O

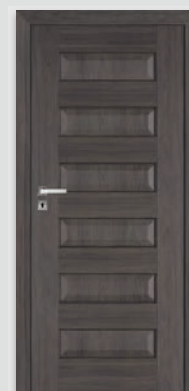

ELSA B



Premium 4 - marrone chestnut structure

DRE-Cell Decor	white (textured)	white matt	white pine	siberian elm	sand oak	bleached oak textured	vintage oak	
	evoke oak	light gray matt	black matt 2	marrone chestnut textured	caramel walnut	anthracite elm	dark wenge	golden oak textured
3D Decor	grand oak	elm	walnut american	ebony*	Polish oak 3D	*while stock last		

## STANDARD OPTIONS

- » stiles made of wood-based panels
- » glass pane MAT DRE 4 mm thick

## OPTION WITHOUT EXTRA CHARGE

- » glass pane DECORMAT BROWN, DECORMAT GRAPHITE and transparent glass pane
- » holes for ventilation sleeves

## REBATED DOOR LEAF

- » straight edge **fig. 1**
- » 3 silver screw-in pivot hinges
- » single-point mortise simple key lock, bathroom lock, cylinder lock or economic lock

## NON-REBATED DOOR LEAF (EXTRA CHARGE)

- » edge without rebate **fig. 2**
- » sockets for 2 recessed Estetic 80 hinges (hinges constitute a part of the door frame)
- » magnetic simple key lock, bathroom lock, cylinder lock or economic lock

## SLIDING SYSTEM DOOR LEAF

- » edge without rebate **fig. 2**
- » socket for hook lock and/or for handles

**NOTE:** There is possibility to make rebated „40” side panels.  
**NOTE:** It is required to use door frame equipped with 3 hinges together with PREMIUM rebated door leaf model.

## OPTIONS AVAILABLE WITH EXTRA CHARGE

- » plastic ventilation sleeves 1 pc.
- » non-rebated door leaf
- » door leaf „90” and „100”
- » ventilation undercut
- » recuperative undercutting -15mm
- » cover strip for non-rebated double leaf door
- » double leaf door door leaf price x2
- » **NOTE:** third Estetic 80 hinge for non-rebated doors (extra charge is added to the price of the door frame)

fig. 1



fixed edge

fig. 2



edge without rebate

In PREMIUM 12 and 13 models, from the top edge there are used two glass panes.



PREMIUM 0-3  
(4 mm glass pane)

\* PREMIUM 4-7, 12  
(4 mm HDF inserts in door leaf colour)

\*\* PREMIUM 8-11, 13  
(4mm HDF inserts, coated with a silver laminate)



PREMIUM 0  
PREMIUM 4\*  
PREMIUM 8\*\*

PREMIUM 1  
PREMIUM 5\*  
PREMIUM 9\*\*

PREMIUM 2  
PREMIUM 6\*  
PREMIUM 10\*\*

PREMIUM 3  
PREMIUM 7\*  
PREMIUM 11\*\*

PREMIUM 12  
2 glass panes, 6  
inserts in the colour of  
the door leaf

PREMIUM 13  
2 glass panes, 6  
inserts coated with a  
silver laminate



PIANO 0 - Polish oak 3D

DRE-Cell Decor	white (textured)	white matt	white pine	siberian elm	sand oak	bleached oak textured	vintage oak	caramel walnut
	anthracite elm	dark wenge	marrone chestnut textured	black matt 2	light gray mat	evoke oak	golden oak textured	
3D Decor	grand oak	elm	walnut american	ebony*	Polish oak 3D	<i>*while stock last</i>		

## STANDARD OPTIONS

- » stiles made of wood-based panels
- » glass pane MAT DRE 4 mm thick
- » 16 mm convex panel (PIANO 1-2, PIANO 5-6) or 19 mm convex panel (PIANO 9-12)

## OPTION WITHOUT EXTRA CHARGE

- » glass pane DECORMAT BROWN, DECORMAT GRAPHITE and transparent glass pane
- » holes for ventilation sleeves

## OPTIONS AVAILABLE WITH EXTRA CHARGE

- » plastic ventilation sleeves 1 pc.
- » non-rebated door leaf
- » door leaf „90” and „100”
- » ventilation undercut
- » recuperative undercutting -15mm
- » cover strip for non-rebated double leaf door
- » double leaf door door leaf price x2
- » **NOTE:** third Estetic 80 hinge for non-rebated doors (extra charge is added to the price of the door frame)

## REBATED DOOR LEAF

- » straight edge **fig. 1**
- » 3 silver screw-in pivot hinges
- » single-point mortise simple key lock, bathroom lock, cylinder lock or economic lock

## NON-REBATED DOOR LEAF (EXTRA CHARGE)

- » edge without rebate **fig. 2**
- » sockets for 2 recessed Estetic 80 hinges (hinges constitute a part of the door frame)
- » magnetic simple key lock, bathroom lock, cylinder lock or economic lock

## SLIDING SYSTEM DOOR LEAF

- » edge without rebate **fig. 2**
- » socket for hook lock and/or for handles

fig. 1

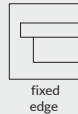
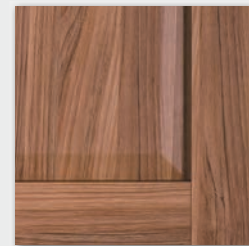
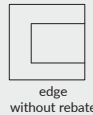

fig. 2



panel PIANO 9-12



PIANO 0

PIANO 1

PIANO 2

PIANO 3

PIANO 4

PIANO 5

PIANO 6



PIANO 9

PIANO 10

PIANO 11

PIANO 12



SCALA 0, SCALA B2 - white matt

DRE-Cell Decor	white (textured)	white matt	white pine	siberian elm	sand oak	bleached oak textured	vintage oak	caramel walnut
	anthracite elm	dark wenge	marrone chestnut textured	black matt 2	light gray mat	evoke oak	golden oak textured	
3D Decor	grand oak	elm	walnut american	ebony*	Polish oak 3D	<i>*while stock last</i>		

**DOOR HANDLE WITH A BACKPLATE**

The promotion applies to rebated and non-rebated door leaves from SCALA collection in DRE-Cell Decor and 3D foil. Door handle model and finishing colors to choose from: WEGA, ATRIA, ARCTUS, POLARIS and ORION door handles and a backplate with a simple key or cylinder or a bathroom lock. The promotion lasts while stocks last.



## STANDARD OPTIONS

- » stiles made of wood-based panels
- » glass pane MAT DRE 4 mm thick
- » flat panel insert (SCALA A), 19 mm profiled MDF panels (SCALA B)

## OPTIONS WITHOUT EXTRA CHARGE

- » glass pane DECORMAT BROWN, DECORMAT GRAPHITE and transparent glass pane
- » holes for ventilation sleeves

## OPTIONS AVAILABLE WITH EXTRA CHARGE

- » plastic ventilation sleeves 1 pc.
- » non-rebated door leaf
- » door leaf „90” and „100”
- » ventilation undercut
- » recuperative undercutting -15mm
- » cover strip for non-rebated double leaf door
- » double leaf door door leaf price x2
- » **NOTE:** third Estetic 80 hinge for non-rebated doors (extra charge is added to the price of the door frame)

## REBATED DOOR LEAF

- » straight edge **fig. 1**
- » 3 silver screw-in pivot hinges
- » single-point mortise simple key lock, bathroom lock, cylinder lock or economic lock

## NON-REBATED DOOR LEAF (EXTRA CHARGE)

- » edge without rebate **fig. 2**
- » sockets for 2 recessed Estetic 80 hinges (hinges constitute a part of the door frame)
- » magnetic simple key lock, bathroom lock, cylinder lock or economic lock

## SLIDING DOOR LEAF

- » edge without rebate **fig. 2**
- » socket for hook lock and/or for handles

**NOTE:** Rebated "40" side panels available.

It is required to use door frame equipped with 3 hinges together with SCALA rebated door leaf model.

SCALA collection is divided into A and B:  
A - flat panel insert in door leaf colour  
B - convex panel insert in door leaf colour

fig. 1

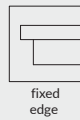
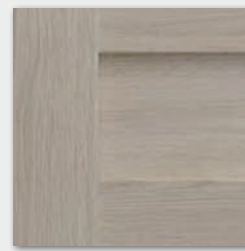
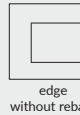

fig. 2



panel SCALA A, A1-A7



panel SCALA B, B1-B7





VERSO 0 - white pine

DRE-Cell  
Decor





## STANDARD OPTIONS

- » stiles made of wood-based panels
- » glass pane MAT DRE 4 mm thick

## OPTIONS WITHOUT EXTRA CHARGE

- » glass pane DECORMAT BROWN, DECORMAT GRAPHITE and transparent glass pane
- » holes for ventilation sleeves

## OPTIONS AVAILABLE WITH EXTRA CHARGE

- » plastic ventilation sleeves 1 pc.
- » non-rebated door leaf
- » door leaf „90” and „100”
- » ventilation undercut
- » recuperative undercutting -15mm
- » cover strip for non-rebated double leaf door
- » double leaf door door leaf price x2
- » **NOTE:** third Estetic 80 hinge for non-rebated doors (extra charge is added to the price of the door frame)

## REBATED DOOR LEAF

- » straight edge **fig. 1**
- » 3 silver screw-in pivot hinges
- » single-point mortise simple key lock, bathroom lock, cylinder lock or economic lock

## NON-REBATED DOOR LEAF (EXTRA CHARGE)

- » edge without rebate **fig. 2**
- » sockets for 2 recessed Estetic 80 hinges (hinges constitute a part of the door frame)
- » magnetic simple key lock, bathroom lock, cylinder lock or economic lock

## SLIDING DOOR LEAF

- » edge without rebate **fig. 2**
- » socket for hook lock and/or for handles

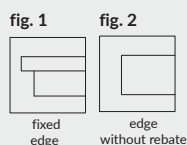

VERSO 0



VERSO 1



VERSO 2



VERSO 3



VERSO 4

\* Note: selected configurations of the VERSO model are available as stock orders, rebated in white matt.



VETRO A1 - dark wenge

DRE-Cell Decor	white (textured)	white matt	white pine	siberian elm	sand oak	bleached oak textured	vintage oak	caramel walnut
	anthracite elm	dark wenge	marrone chestnut textured	black matt 2	light gray mat	evoke oak	toffee oak***	golden oak textured
3D Decor	grand oak	elm	walnut american	ebony*	Polish oak 3D	*** decor available only in horizontal wood grain *while stock last		

**NOTE:** It is possible to order non-rebated door leaf in Dre-Cell white matt colour

cross-section of stile in non-rebated door leaf

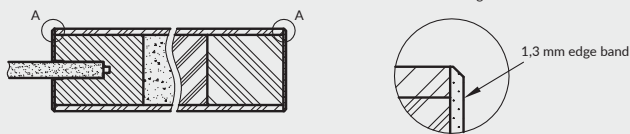

VETRO collection glass panes have obverse and reverse sides (important in two door leaves opening inversely). The below horizontal cross-sections show the arrangement of the glass pane in the obverse version. When selecting the reverse version, the glass pane is rotated 180° around the vertical axis.

Horizontal cross-section of door leaf VETRO A1-A4, A12-A15

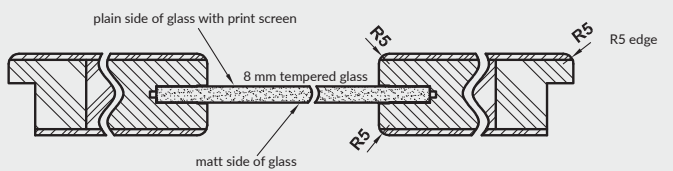

Horizontal cross-section of door leaf VETRO A5, A10 - A11

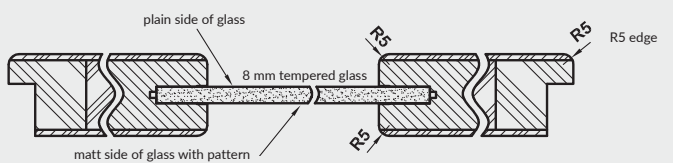

## STANDARD OPTIONS

- » reinforced MDF frame
- » core made of tubular chipboard
- » 8 mm tempered glass

## OPTIONS WITHOUT EXTRA CHARGE

- » there is possibility to make ventilation undercut (A)
- » door leaf with revers positioning of glass pane
- » VETRO A1 four possible types of glass pane: DECORMAT, DECORMAT BROWN, DECORMAT GRAPHITE and transparent glass

## REBATED DOOR LEAF

- » R5 edge **fig. 1**
- » 3 silver screw-in pivot hinges
- » single-point mortise simple key lock, bathroom lock, cylinder lock or economic lock

## NON-REBATED DOOR LEAF (extra charge)

### ONLY WHITE MATT

- » edge without rebate **fig. 2**
- » sockets for 2 recessed Estetic 80 hinges (hinges constitute a part of the door frame)
- » magnetic simple key lock, bathroom lock, cylinder lock or economic lock

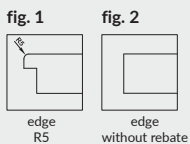

## OPTIONS AVAILABLE WITH EXTRA CHARGE - AVAILABLE ONLY IN WHITE MATT DRE-CELL DECOR

- » non-rebated door leaf
- » **NOTE:** third Estetic 80 hinge for non-rebated doors (extra charge is added to the price of the door frame)

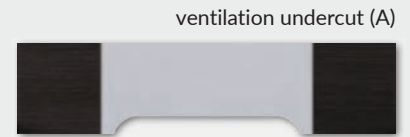

## SLIDING DOOR LEAF

- » edge without rebate **fig. 2**
- » socket for hook lock and/or for handles

**NOTE:** Door leaf VETRO A in sliding version is not complementary product to sliding system hidden in the wall PA.

**NOTE:** There is no possibility to shorten door leaf.  
**NOTE:** It is required to use door frame equipped with 3 hinges together with VETRO rebated door leaf model.  
VETRO A - „80“-„100“ with ventilation undercut fulfill ventilation requirements.





### VETRO B14 - evoke oak

DRE-Cell Decor	white (textured)	white matt	white pine	siberian elm	sand oak	bleached oak textured	vintage oak	caramel walnut
	golden oak textured	anthracite elm	wenge dark	marrone chestnut textured	black matt 2	light gray matt	evoke oak	toffee oak*** *
3D Decor	grand oak	elm	walnut american	ebony*	Polish oak 3D	*** decor available only in horizontal wood grain *while stock last		

**NOTE:** It is possible to order non-rebated door leaf in Dre-Cell white matt colour

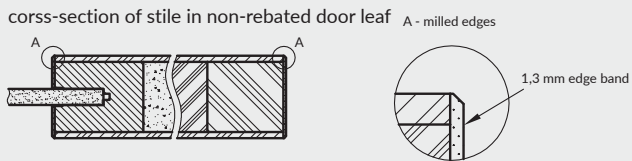

VETRO collection glass panes have obverse and reverse sides (important in two door leaves opening inversely). The below horizontal cross-sections show the arrangement of the glass pane in the obverse version. When selecting the reverse version, the glass pane is rotated 180° around the vertical axis.

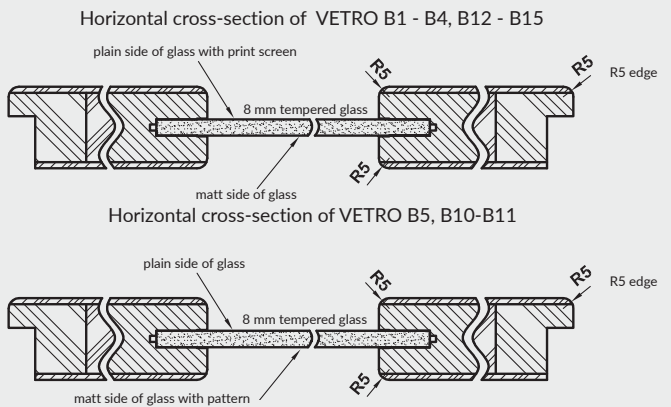

## STANDARD OPTIONS

- » reinforced MDF frame
- » core made of tubular chipboard
- » 8 mm tempered glass

## OPTIONS WITHOUT EXTRA CHARGE

- » there is possibility to make ventilation undercut (B)
- » VETRO B1 four possible types of glass pane: DECORMAT, DECORMAT BROWN, DECORMAT GRAPHITE and transparent glass
- » door leaf with revers positioning of glass pane

## OPTIONS AVAILABLE WITH EXTRA CHARGE - AVAILABLE ONLY IN WHITE MATT DRE-CELL DECOR

- » non-rebated door leaf
- » **NOTE:** third Estetic 80 hinge for non-rebated doors (extra charge is added to the price of the door frame)

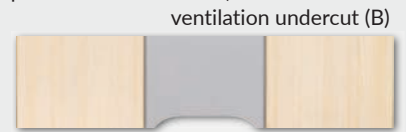

VETRO B - doesn't fulfill ventilation requirements

## REBATED DOOR LEAF

- » R5 edge **fig. 1**
- » 3 silver screw-in pivot hinges
- » single-point mortise simple key lock, bathroom lock, cylinder lock or economic lock

## NON-REBATED DOOR LEAF (extra charge)

### ONLY WHITE MATT

- » edge without rebate **fig. 2**
- » sockets for 2 recessed Estetic 80 hinges (hinges constitute a part of the door frame)
- » magnetic simple key lock, bathroom lock, cylinder lock or economic lock

## SLIDING DOOR LEAF

- » edge without rebate **fig. 2**
- » socket for hook lock and/or for handles

**NOTE:** Door leaf VETRO B in sliding version with "70" width is not complementary product to sliding system hidden in the wall PA.

**NOTE:** There is no possibility to shorten door leaf.

**NOTE:** It is required to use door frame equipped with 3 hinges together with VETRO rebated door leaf model.

VETRO B - doesn't fulfill ventilation requirements.

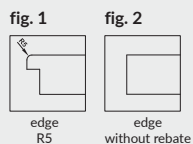



VETRO D1 - anthracite elm

DRE-Cell Decor	white (textured)	white matt	white pine	siberian elm	sand oak	bleached oak textured	vintage oak	caramel walnut
	anthracite elm	dark wenge	marrone chestnut textured	black matt 2	light gray matt	evoke oak	toffee oak***, *	golden oak textured
3D Decor	grand oak	elm	walnut american	ebony*	Polish oak 3D	*** decor available only in horizontal wood grain *while stock last		

**NOTE:** It is possible to order non-rebated door leaf in Dre-Cell white matt colour

VETRO collection glass panes have obverse and reverse sides (important in two door leaves opening inversely). The below horizontal cross-section shows the arrangement of the glass pane in the obverse version. When selecting the reverse version, the glass pane is rotated 180° around the vertical axis.

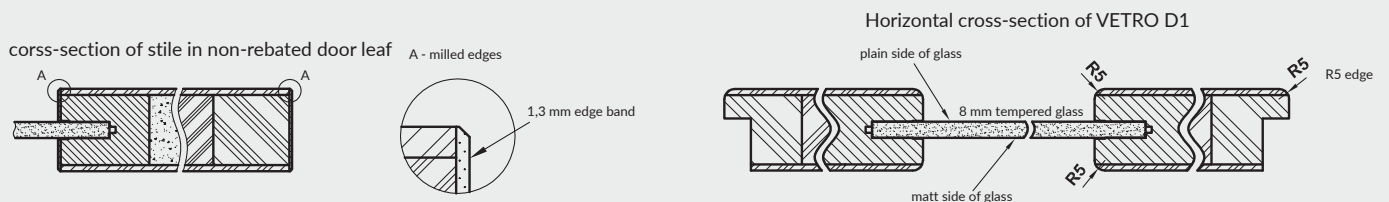

## STANDARD OPTIONS

- » reinforced MDF frame: narrow element with fixed width, wide element with variable width
- » core made of tubular chipboard
- » 8 mm tempered glass with fixed width, (regardless of the door leaf width)

## OPTIONS WITHOUT EXTRA CHARGE

- » door leaf with revers positioning of glass pane

## OPTIONS AVAILABLE WITH EXTRA CHARGE

- » ventilation undercut
- » black tempered laminated glass pane

## REBATED DOOR LEAF

- » R5 edge **fig. 1**
- » 3 silver screw-in pivot hinges
- » single-point mortise simple key lock, bathroom lock, cylinder lock or economic lock

## NON-REBATED DOOR LEAF (extra charge)

### ONLY WHITE MATT

- » edge without rebate **fig. 2**
- » sockets for 2 recessed Estetic 80 hinges (hinges constitute a part of the door frame)
- » magnetic simple key lock, bathroom lock, cylinder lock or economic lock

fig. 1



edge  
R5

fig. 2



edge  
without rebate

## OPTIONS AVAILABLE WITH EXTRA CHARGE - AVAILABLE ONLY IN WHITE MAT DRE- CELL DECOR

- » non-rebated door leaf
- » **NOTE:** third Estetic 80 hinge for non-rebated doors (extra charge is added to the price of the door frame)  
ventilation undercut



## SLIDING DOOR LEAF

- » edge without rebate **fig. 2**
- » socket for hook lock and/or for handles

**NOTE:** Door leaf VETRO D in sliding version is not complementary product to sliding system hidden in the wall PA.

**NOTE:** There is no possibility to shorten door leaf.

VETRO D - widths "80" - "100" with ventilation undercut fulfill ventilation requirements.

**NOTE:** It is required to use door frame equipped with 3 hinges together with VETRO rebated door leaf model.



VETRO D1  
glass pane  
transparent

VETRO D1  
decormat

VETRO D1  
decormat brown

VETRO D1  
decormat  
graphite



LUMIO 1 - alpine white

FINISH  
decor

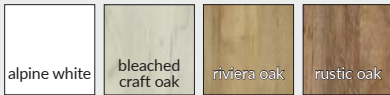



### STANDARD OPTIONS

- » stiles made of wood-based panels
- » glass pane MAT DRE 4 mm thick
- » flat inserts (LUMIO 7-9)

### OPTIONS WITHOUT EXTRA CHARGE

- » glass pane DECORMAT BROWN, DECORMAT GRAPHITE and transparent glass pane
- » holes for ventilation sleeves
- » 4mm HDF flat panel gloss black lacquered in LUMIO 1, 7, 9 models - instead of a glass pane

### REBATED DOOR LEAF

- » straight edge **fig. 1**
- » 3 silver screw-in pivot hinges
- » single-point mortise simple key lock, bathroom lock, cylinder lock or economic lock **NOTE:** 3 hinges door frames should be used with LUMIO rebated door leaves .

### OPTIONS AVAILABLE WITH EXTRA CHARGE

- » plastic ventilation sleeves 1 pc.
- » door leaf „90" and „100"
- » ventilation undercut
- » recuperative undercutting -15mm
- » black safety composite glass VSG 22.1
- LUMIO 1
- LUMIO 2
- LUMIO 3, 6
- LUMIO 4
- LUMIO 5
- LUMIO 7
- LUMIO 9
- double leaf door door leaf price x2

fig. 1



\* Note: Selected configurations of LUMIO 1 and LUMIO 9 models are available from stock, rebated in alpine white .





VICO 7 - riviera oak

FINISH  
decor

alpine white	bleached craft oak	riviera oak	rustic oak
--------------	--------------------	-------------	------------

### STANDARD OPTIONS

- » stiles made of wood-based panels
- » glass pane MAT DRE 4 mm thick
- » flat inserts (VICO 5-7)

### OPTIONS WITHOUT EXTRA CHARGE

- » glass pane DECORMAT BROWN, DECORMAT GRAPHITE and transparent glass pane
- » holes for ventilation sleeves
- » 4mm HDF flat panel gloss black lacquered in VICO 1, 5, 7 models - instead of a glass pane

### REBATED DOOR LEAF

- » straight edge **fig. 1**
- » 3 silver screw-in pivot hinges
- » single-point mortise simple key lock, bathroom lock, cylinder lock or economic lock **NOTE:** 3 hinges door frames should be used with rebated door leaves VICO .

### OPTIONS AVAILABLE WITH EXTRA CHARGE

- » plastic ventilation sleeves 1 pc.
- » door leaf „90” and „100”
- » ventilation undercut
- » recuperative undercutting -15mm
- » black safety composite glass pane VSG 22.1
- VICO 1
- VICO 2
- VICO 3.4
- VICO 5
- VICO 7
- » double leaf door door leaf price x2

fig. 1

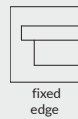



## BERGE 6 - white

Painted  
decor



white acrylic UV varnish - RAL 9003  
ecru - RAL 9001  
latte - Flugger 4362, NCS S1505-Y50R  
ashen - RAL 7035

### STANDARD OPTIONS

- » door leaf painted with acrylic UV varnish
- » stiles made of wood-based panels
- » glass pane MAT DRE 4 mm thick
- » profiled 19mm MDF panels

### OPTIONS WITHOUT EXTRA CHARGE

- » glass pane DECORMAT BROWN, DECORMAT GRAPHITE and transparent glass pane
- » holes for ventilation sleeves

### OPTIONS AVAILABLE WITH EXTRA CHARGE

- » plastic ventilation sleeves 1 pc.
- » non-rebated door leaf
- » door leaf „90” and „100”
- » ventilation undercut
- » recuperative undercutting -15mm
- » cover strip for non-rebated double leaf door
- » double leaf door door leaf price x2
- » **NOTE:** third Estetic 80 hinge for non-rebated doors (extra charge is added to the price of the door frame)

### REBATED DOOR LEAF

- » straight edge **fig. 1**
- » 3 silver screw-in pivot hinges
- » single-point mortise simple key lock, bathroom lock, cylinder lock or economic lock

### NON-REBATED DOOR LEAF (EXTRA CHARGE)

- » edge without rebate **fig. 2**
- » sockets for 2 recessed Estetic 80 hinges (hinges constitute a part of the door frame)
- » magnetic simple key lock, bathroom lock, cylinder insert lock or economic lock in steel, black or white color

### SLIDING DOOR LEAF

- » edge without rebate **fig. 2**
- » socket for hook lock and/or for handles

**NOTE:** It is required to use door frame equipped with 3 hinges together with BERGE rebated door leaf model .

fig. 1



fig. 2

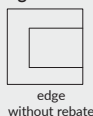

edge without rebate

To ensure the highest quality of painted products, before painting process, both, door leaf and door frames are coated with special material which constitutes solid base.





## EVEN 0, 3 - white

Painted  
decor



white acrylic UV varnish - RAL 9003  
ecru - RAL 9001  
latte - Flugger 4362, NCS S1505-Y50R  
ashen - RAL 7035

### STANDARD OPTIONS

- » door leaf painted with acrylic UV varnish
- » stiles made of wood-based panels
- » glass pane MAT DRE 4 mm thick

### OPTIONS WITHOUT EXTRA CHARGE

- » glass pane DECORMAT BROWN, DECORMAT GRAPHITE and transparent glass pane
- » holes for ventilation sleeves

### REBATED DOOR LEAF

- » straight edge **fig. 1**
- » 3 silver screw-in pivot hinges
- » single-point mortise simple key lock, bathroom lock, cylinder lock or economic lock

### NON-REBATED DOOR LEAF (EXTRA CHARGE)

- » edge without rebate **fig. 2**
- » sockets for 2 recessed Estetic 80 hinges (hinges constitute a part of the door frame)
- » magnetic simple key lock, bathroom lock, cylinder insert lock or economic lock in steel, black or white color

### SLIDING DOOR LEAF

- » edge without rebate **fig. 2**
- » socket for hook lock and/or for handles

**NOTE:** It is required to use door frame equipped with 3 hinges together with rebated door leaf.

### OPTIONS AVAILABLE WITH EXTRA CHARGE

- » plastic ventilation sleeves 1 pc.
- » non-rebated door leaf
- » door leaf „90” and „100”
- » ventilation undercut
- » recuperative undercutting -15mm
- » cover strip for non-rebated double leaf door
- » double leaf door door leaf price x2
- » **NOTE:** third Estetic 80 hinge for non-rebated doors (extra charge is added to the price of the door frame)

fig. 1

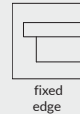
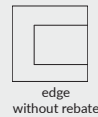

fig. 2



To ensure the highest quality of painted products, before painting process, both, door leaf and door frames are coated with special material which constitutes solid base.





## NESTOR 12 - white

Painted  
decor



white acrylic UV varnish - RAL 9003  
ecru - RAL 9001  
latte - Flügger 4362, NCS S1505-Y50R  
ashen - RAL 7035



## STANDARD OPTIONS

- » door leaf painted with acrylic UV varnish
- » stiles made of wood-based panels
- » glass pane MAT DRE 4 mm thick
- » profiled 19mm MDF panels

## OPTIONS WITHOUT EXTRA CHARGE

- » glass pane DECORMAT BROWN, DECORMAT GRAPHITE and transparent glass pane
- » holes for ventilation sleeves

## REBATED DOOR LEAF

- » straight edge **fig. 1**
- » 3 silver screw-in pivot hinges
- » single-point mortise simple key lock, bathroom lock, cylinder lock or economic lock

## NON-REBATED DOOR LEAF (EXTRA CHARGE)

- » edge without rebate **fig. 2**
- » sockets for 2 recessed Estetic 80 hinges (hinges constitute a part of the door frame)
- » magnetic simple key lock, bathroom lock, cylinder insert lock or economic lock in steel, black or white color

## SLIDING DOOR LEAF

- » edge without rebate **fig. 2**
- » socket for hook lock and/or for handles

## DOOR LEAF WITH INVERTED REBATE (extra charge)

- » active single leaf door
- » straight edge **fig 3**
- » sockets for two recessed Estetic 1821 hinges (hinges constitute a part of the door frame)
- » magnetic simple key lock, bathroom lock, cylinder lock or economic lock

To ensure the highest quality of painted products, before painting process, both, door leaf and door frames are coated with special material which constitutes solid base.

## OPTIONS AVAILABLE WITH EXTRA CHARGE

- » plastic ventilation sleeves 1 pc.
- » non-rebated door leaf
- » door leaf „90” and „100”
- » ventilation undercut
- » recuperative undercutting -15mm
- » door leaf with inverted rebate
- » cover strip for non-rebated double leaf door
- » double leaf door door leaf price x2

**NOTE:** third Estetic 80 hinge for non-rebated doors (extra charge is added to the price of the door frame)

**NOTE:** It is required to use together with NESTOR rebated door leaf model door frames equipped with 3 hinges.

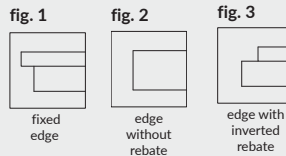

panel  
NESTOR





## VETRO E - latte

Painted  
decor



white acrylic UV varnish - RAL 9003  
 ecru - RAL 9001  
 latte - Flugger 4362, NCS S1505-Y50R  
 ashen - RAL 7035

Horizontal cross-section of rebated VETRO E doors

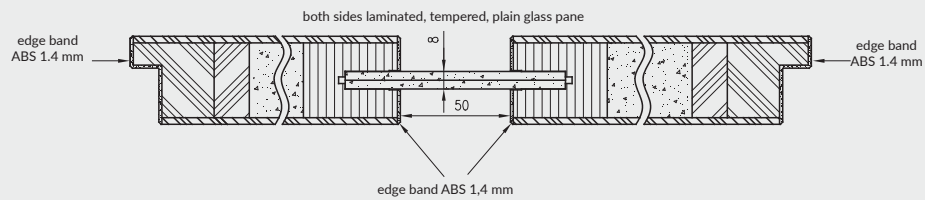

Horizontal cross-section of non-rebated VETRO E doors

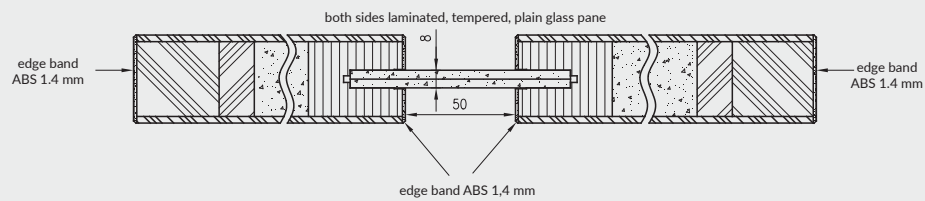

## STANDARD OPTIONS

- » door leaf painted with acrylic UV varnish
- » reinforced MDF frame: narrow element with fixed width, wide element with variable width
- » core made of tubular chipboard
- » DECORMAT tempered laminated 8 mm glass pane with fixed width (regardless the width of the door leaf) or laminated black tempered 8 mm glass pane (opaque) with fixed width (regardless the door leaf width)

## REBATED DOOR LEAF

- » straight edge **fig. 1**
  - » 3 silver screw-in pivot hinges
  - » single-point mortise simple key lock, bathroom lock, cylinder lock or economic lock
- ## NON-REBATED DOOR LEAF (extra charge)
- » edge without rebate **fig. 2**
  - » sockets for 2 recessed Estetic 80 hinges (hinges constitute a part of the door frame)
  - » magnetic simple key lock, bathroom lock, cylinder insert lock or economic lock in steel, black or white color

**NOTE:** There is no possibility to shorten door leaf.

VETRO E - widths "80" - "100" with ventilation undercut fulfill ventilation requirements.

To ensure the highest quality of painted products, before painting process, both, door leaf and door frames are coated with special material which constitutes solid base.

## OPTIONS AVAILABLE WITH EXTRA CHARGE

- » **NOTE:** third Estetic 80 hinge for non-rebated doors (extra charge is added to the price of the door frame)
- » ventilation undercut
- » non-rebated door leaf



## SLIDING DOOR LEAF

- » edge without rebate **fig. 2**
- » socket for hook lock and/or for handles

**NOTE:** sliding VETRO E door leaves do not fit the sliding system with the PA door frame cassette.

**NOTE:** There is no possibility to shorten door leaf.

VETRO E - meets ventilation requirements for widths "80" - "100" with ventilation undercut

**NOTE:** It is required to use together with VETRO rebated door leaf model door frames equipped with 3 hinges.



VETRO E  
white  
(black glass pane)



VETRO E  
ecru  
(black glass pane)



VETRO E  
latte  
(DECORMAT glass  
pane)



VETRO E  
ashen  
(DECORMAT glass  
pane)



NOVA 80 - sage oak, brushed gold inlay

	NEW								
Decor 1st group	antique copper	oxide concrete	white matt	light gray matt	dark olive matt	dark blue matt	cashmere matt	warm gray matt	sage oak
Decor 2nd group	black ST								
Inlays	brushed steel	brushed gold	mat moro						

Possible model options:

M1 - FULL DOOR LEAF, WITHOUT GLAZING

NOVA 20 - MDF bulaj

NOVA 30 - STEEL BULAJ (AVAILABLE ONLY MAT OR TRANSPARENT GLASS PANE)

NOVA 40 - MDF frame in black matt 2 foil

NOVA 50 - 80 Vertical inlays made of laminate: brushed steel, brushed gold or moro matt

Steel BULAJ NOVA 30 - steel or black. Only matt or transparent glass pane available.

### STANDARD OPTIONS

- » door leaf frame made of softwood
- » core made of „honeycomb“
- » glass pane MAT DRE 4 mm thick
- » the edge in the color of the door leaf or black
- » concrete oxide and antique copper decors available only with black edge

### OPTIONS WITHOUT EXTRA CHARGE

- » ventilation sleeves
- » three hinges - applies to rebated door leaf
- » DECORMAT BROWN, DECORMAT GRAPHITE glass pane and transparent glass

### REBATED DOOR LEAF

- » straight edge fig. 1
- » 2 screw-in hinges in silver or black color
- » silver or black deadbolt lock with a simple key, bathroom lock, cylinder lock or economic lock

### NON-REBATED DOOR LEAF (EXTRA CHARGE)

- » edge without rebate fig. 2
- » sockets for 2 recessed Estetic 80 hinges (hinges constitute a part of the door frame)
- » magnetic simple key lock, bathroom lock, cylinder insert lock or economic lock in steel, black or white color

### SLIDING DOOR LEAF

- » edge without rebate fig. 2
- » socket for hook lock and/or for handles

### DOOR LEAF WITH INVERTED REBATE (extra charge)

- » active single leaf door
- » straight edge fig 3
- » sockets for two recessed Estetic 1821 hinges (hinges constitute a part of the door frame)
- » magnetic simple key lock, bathroom lock, cylinder lock or economic lock

- » does not apply to door leaves with antique copper or oxide concrete decors

### DOOR FRAMES

- » for door leaves from NOVA collection it is recommended to use door frames in the same colour as door leaf or in black matt 2 decor

### OPTIONS AVAILABLE WITH EXTRA CHARGE

- » Silent 37dB package (dropping seal + acoustic filling) - NOVA 10, 50 - 80
- » stabilising insert tubular chipboard
- » non-rebated door leaf
- » door leaf "90", "100"
- » ventilation undercut
- » recuperative undercutting -15mm
- » door leaf with inverted rebate
- » plastic ventilation grille
- » aluminum ventilation grille
- » there is possibility to purchase black or stainless steel BULAJ separately

- » **NOTE:** third Estetic 80 hinge for non-rebated doors (extra charge is added to the price of the door frame)

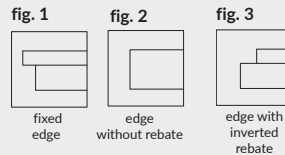

- » **NOTE:** the Silent package applies to rebated and non-rebated single leaf door.





WOOD M1 design W2 - dark oak

Decor

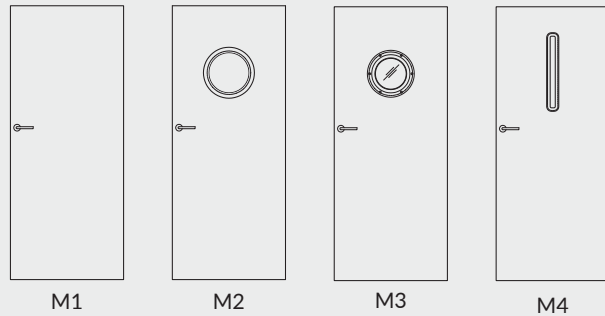
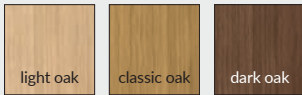

**Model options with possibility to choose graphic patterns W1-W4 :**

- M1 - full door leaf, without glazing
- M2 - MDF bulaj in black matt decor
- M3 - steel BULAJ in steel or black colour (only MATT or transparent glass pane available)
- M4 - MDF frame in black matt decor

### STANDARD OPTIONS

- » door leaf surface coated with the primer material, overprinted with the pattern and varnished
- » matt lacquer
- » door leaf frame made of MDF
- » stabilising insert honeycomb
- » glass pane MAT DRE 4 mm thick

### NON-REBATED DOOR LEAF

- » edge without rebate in the colour of the door leaf
- » sockets for 2 recessed Estetic 80 hinges in steel, black or white color (hinges constitute a part of the door frame)
- » magnetic simple key lock, bathroom lock, cylinder insert lock or economic lock in steel, black or white color

### DOOR FRAMES

- » for the door leaves from the WOOD collection, we recommend to use lacquered frames made in the DRE-PRINT technology in the colour of door leaf unit

### OPTION WITHOUT EXTRA CHARGE

- » holes for ventilation sleeves
- » glass pane DECORMAT BROWN, DECORMAT GRAPHITE and transparent glass pane

### OPTIONS AVAILABLE WITH EXTRA CHARGE

- » door leaf „100”
- » stabilising insert tubular chipboard
- » ventilation undercut
- » **NOTE** : third Estetic 80 hinge for non-rebated doors (extra charge is added to the price of the door frame)
- » aluminum ventilation grille

fig. 1



edge  
without rebate



W1

W2

W3

W4



## CLARO M1

Decor





### HIGH GLOSS LACQUER AS STANDARD

- » door leaf surface is coated with primer material and varnished
- » gloss varnish
- » door leaf frame made of MDF
- » core made of perforated chipboard
- » 4mm DRE MATT glass pane

### MATT LACQUER AS STANDARD

- » door leaf surface is coated with primer material and varnished
- » matt lacquer
- » door leaf frame made of MDF
- » core made of „honeycomb”
- » 4mm DRE MATT glass pane

### NON-REBATED DOOR LEAF

- » edge without rebate in white or black colour fig.1
- » sockets for 2 recessed Estetic 80 hinges in white, steel or black color (hinges constitute a part of the door frame)
- » magnetic simple key lock, bathroom lock, cylinder insert lock or economic lock in steel, black or white color

### DOOR FRAMES

- » for DRE-CLARO collection , we recommend to use white, black lacquered door frames made in DRE-PRINT technology, or door frames in black matt 2

### OPTION WITHOUT EXTRA CHARGE

- » holes for ventilation sleeves
- » glass pane DECORMAT BROWN, DECORMAT GRAPHITE and transparent glass pane

### OPTIONS AVAILABLE WITH EXTRA CHARGE

- » door leaf „100”
- » ventilation undercut
- » stabilising insert tubular chipboard in matt lacquered door leaves

**NOTE :** third Estetic 80 hinge for non-rebated doors (extra charge is added to the price of the door frame)

- » aluminum ventilation grille

fig. 1

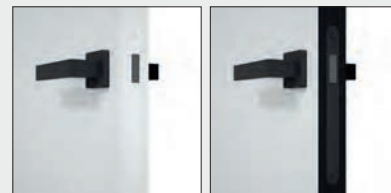
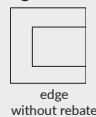

white edgeband,  
white lock

black edgeband,  
black lock



M 1 - CLARO

M 2 - CLARO

M 3 - CLARO

M 4 - CLARO

Possible model options:

- M1 - full door leaf, without glazing
- M2 - MDF bulaj in black matt decor
- M3 - steel bulaj (matt or transparent glass pane)
- M4 - MDF frame in black matt decor

Steel BULAJ M3 - steel or black. Only matt or transparent glass pane available.



GRAFI M4-G2

### STANDARD HIGH GLOSS LACQUERED DOOR LEAF

- » door leaf surface coated with the primer material, overprinted with the pattern and varnished (colour of the door leaf primed surface - white)
- » high gloss lacquer
- » door leaf frame made of MDF
- » core made of tubular chipboard
- » MAT DRE glass pane 4 mm thick (model M2, M4)

### STANDARD MATT LACQUERED DOOR LEAF

- » door leaf surface coated with the primer material, overprinted with the pattern and varnished (colour of the door leaf primed surface - white)
- » matt lacquer
- » door leaf frame made of MDF
- » core made of „honeycomb”
- » MAT DRE glass pane 4 mm thick (model M2, M4)

### NON-REBATED DOOR LEAF

- » edge without rebate in white or black colour fig.1
- » sockets for 2 recessed Estetic 80 hinges in white, steel or black color (hinges constitute a part of the door frame)
- » magnetic simple key lock, bathroom lock, cylinder insert lock or economic lock in steel, black or white color

### DOOR FRAMES

- » for GRAFI collection , we recommend to use white, black lacquered door frames made in DRE-PRINT technology, or door frames in black matt 2

### OPTION WITHOUT EXTRA CHARGE

- » holes for ventilation sleeves
- » DECORMAT BROWN, DECORMAT GRAPHITE glass pane and transparent glass

### OPTIONS AVAILABLE WITH EXTRA CHARGE

- » door leaf „100”
- » ventilation undercut
- » stabilising insert tubular chipboard in matt lacquered door leaves

**NOTE :** third Estetic 80 hinge for non-rebated doors (extra charge is added to the price of the door frame)  
» aluminum ventilation grille

fig. 1



edge without rebate



white edgeband, white lock



black edgeband, black lock

### Model options with possibility to choose graphic patterns G1-G25 :

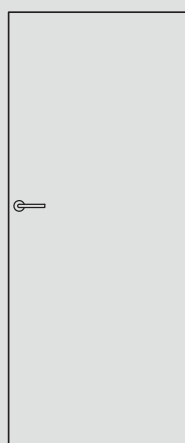

M1

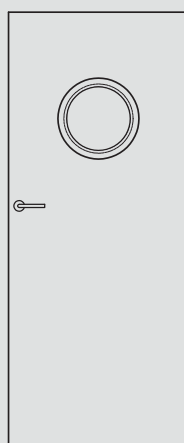

M2

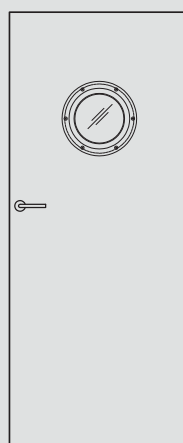

M3

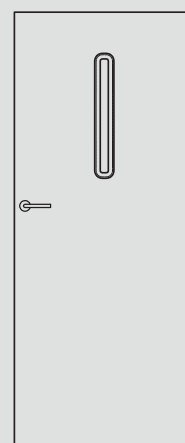

M4

- M1 - full door leaf, without glazing
- M2 - MDF bulaj in black matt decor
- M3 - steel BULAJ in steel or black colour (only MATT or transparent glass pane available)
- M4 - MDF frame in black matt decor

Graphic patterns available on pages 60-61, 170-173.



G1



G2



G3



G4



G5



G6



G7



G8



G9

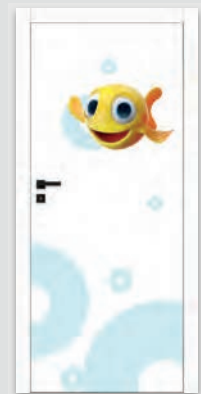

G10

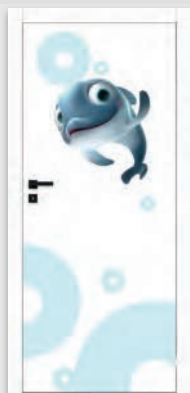

G11

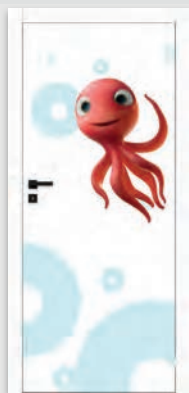

G12



G13

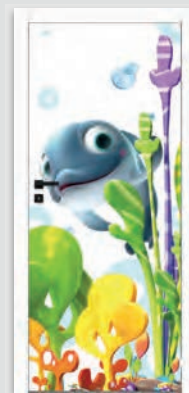

G14

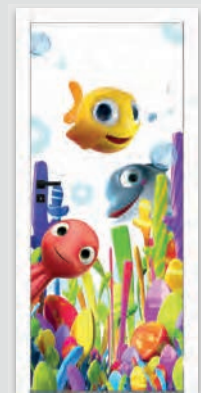

G15



G16



G17\*



G18\*



G19

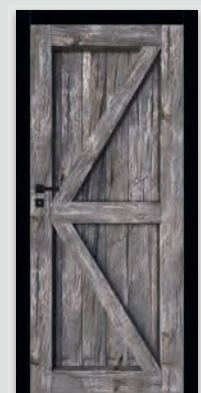

G20\*



## GRAFI M1 G16

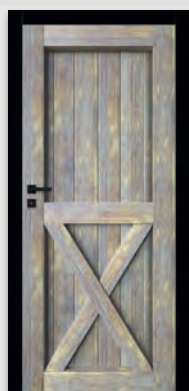

G21

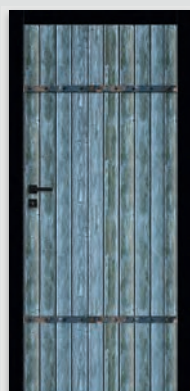

G22



G23



G24 \*



G25

\* pattern versions available for the right and left door leaf

Door leaf width: single leaf door „60”÷”100” .

Technical information: door frames: p. 140, accessories: p. 160-167 and 177, door leaves: p. 178-186.



LUX 10 birch

Decor

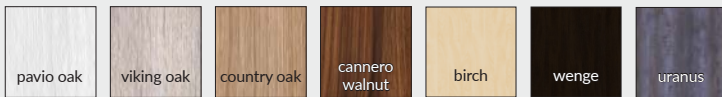

### STANDARD OPTIONS

- » door leaf surface is coated with primer material in the colour of decor and varnished
- » high gloss lacquer
- » door leaf frame made of MDF
- » core made of perforated chipboard
- » MAT DRE glass pane 4 mm thick (model LUX 20, LUX 40)

### NON-REBATED DOOR LEAF

- » edge without rebate in black colour fig.1
- » sockets for 2 recessed Estetic 80 hinges in black, white or steel color (hinges constitute a part of the door frame)
- » magnetic simple key lock, bathroom lock, cylinder insert lock or economic lock in steel, black or white color

### DOOR FRAMES

for door leaves from LUX collection we recommend to use door frames lacquered in the same colour as the door leaf unit or in black matt decor 2

### OPTION WITHOUT EXTRA CHARGE

- » holes for ventilation sleeves
- » DECORMAT BROWN, DECORMAT GRAPHITE glass pane and transparent glass

### OPTIONS AVAILABLE WITH EXTRA CHARGE

- » door leaf „100”
- » ventilation undercut
- » **NOTE:** third Estetic 80 hinge for non-rebated doors (extra charge is added to the price of the door frame)
- » aluminum ventilation grille

fig. 1

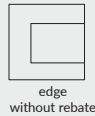

edge  
without rebate



black edgeband,  
black lock



LUX 10



LUX 20



LUX 30



LUX 40

Steel BULAJ LUX 30 - steel or black. Only matt or transparent glass pane available.



Nova 10 - natural halifax oak

EGGER 3 mm laminates 1st group			
	gray oak halifax	natural oak halifax	Halifax Tabac Oak
	CLEAF 4 mm laminates 2nd group		
white elm		natural elm	dark elm
Inlays			
	brushed steel	brushed gold	mat moro



### STANDARD OPTIONS

- » door leaf surface is coated with laminated, synchronous 3 mm or 4 mm thick board
- » door leaf frame made of softwood
- » core made of „honeycomb“
- » glass pane MAT DRE 4 mm thick
- » edgeband in black colour
- » for natural halifax oak decor, the edge in the color of the door leaf or black
- » NOVA 50 - 80 Vertical inlays made of laminate: brushed steel, brushed gold or moro matt

### OPTIONS WITHOUT EXTRA CHARGE

- » ventilation sleeves
- » three hinges - applies to rebated door leaf
- » DECORMAT BROWN, DECORMAT GRAPHITE glass pane and transparent glass

### REBATED DOOR LEAF

- » straight edge fig. 1
- » 2 screw-in hinges in silver or black color
- » silver or black deadbolt lock with a simple key, bathroom lock, cylinder lock or economic lock

### NON-REBATED DOOR LEAF (EXTRA CHARGE)

- » edge without rebate fig. 2
- » sockets for 2 recessed Estetic 80 hinges (hinges constitute a part of the door frame)
- » magnetic simple key lock, bathroom lock, cylinder insert lock or economic lock in steel, black or white color

### SLIDING DOOR LEAF

- » edge without rebate fig. 2
- » socket for hook lock and/or for handles

### DOOR FRAMES

- » for door leaves from NOVA collection, we recommend door frames in the DRE-CELL black matt 2 foil and in CPL natural halifax oak laminate for door leaves made in the natural halifax oak laminate, in a longitudinal arrangement in the second CPL price group

### OPTIONS AVAILABLE WITH EXTRA CHARGE

- » Silent package 37dB (dropping gasket + acoustic insert) - NOVA 10, 1st group Egger laminates
- » stabilising insert tubular chipboard
- » non-rebated door leaf
- » "100" door leaves
- » ventilation undercut
- » recuperative undercutting -15mm
- » plastic ventilation grille
- » aluminum ventilation grille
- » there is possibility to purchase black or stainless steel BULAJ separately

» **NOTE:** third Estetic 80 hinge for non-rebated doors (extra charge is added to the price of the door frame)

» **NOTE:** the Silent package applies to rebated and non-rebated single leaf door.

Steel BULAJ NOVA 30 - steel or black. Only matt or transparent glass pane available.

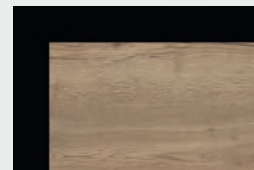
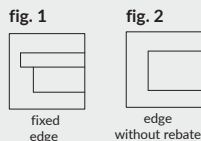

The option of combining the door frame in the DRE-Cell black matt 2 foil and natural halifax oak laminate

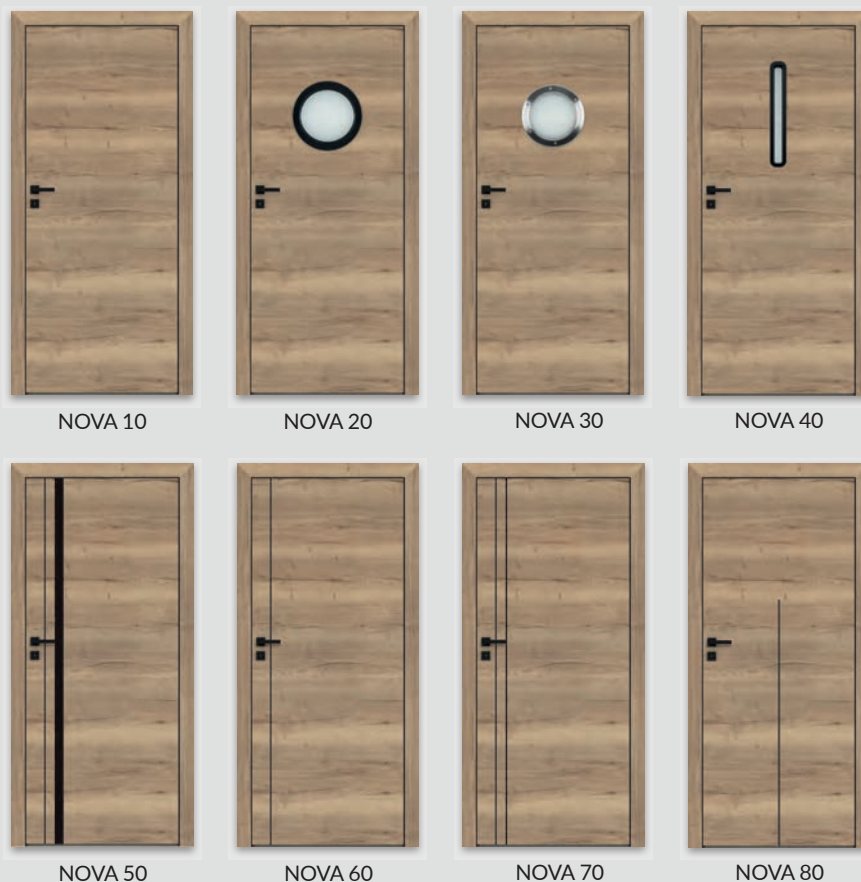



## RIVIA 10 - marrone chestnut / black ST

DRE-Cell Decor	white matt	white pine	siberian elm	silver	sand oak	bleached oak textured	vintage oak	golden oak textured
	walnut	caramel walnut	anthracite elm	dark wenge	toffee oak * **	marrone chestnut textured	evoke oak	light gray matt
3D Decor	grand oak	elm	walnut american	ebony*	Polish oak 3D	*while stock last **decor available only in horizontal graining		



Rivia 20 white matt base



Rivia 20 black ST base

## STANDARD OPTIONS

- » door leaf frame made of softwood
- » core made of tubular chipboard
- » glass pane white bark 4 mm thick

## OPTIONS WITHOUT EXTRA CHARGE

- » glass pane „chinchila” or „window blind”
- » ventilation sleeves
- » three hinges - applies to rebated door leaf

## REBATED DOOR LEAF

- » straight edge, flat uniform glass pane frame **fig. 1**
- » 2 silver screw-in pivot hinges
- » single-point mortise simple key lock, bathroom lock, cylinder lock or economic lock

## NON-REBATED DOOR LEAF (EXTRA CHARGE)

- » edge without rebate, flat uniform glass pane frame , **rys. 2**
- » sockets for 2 recessed Estetic 80 hinges (hinges constitute a part of the door frame)
- » magnetic simple key lock, bathroom lock, cylinder lock or economic lock

## SLIDING DOOR LEAF

- » edge without rebate, flat uniform glass pane frame **fig. 2**
- » socket for hook lock and/or for handles

**NOTE:** The door leaf is made in white matt or black ST with a choice of a center stripe decor. The edge of the door leaf is in the color of the central stripe. RIVIA 40 - BULAJ covered with white or black PVC foil, RIVIA 50 - BULAJ covered with silver foil.

By default , the configurator selects the colour of the door frame in the same colour as the middle strip of the door leaf unit.

\*\*\* In RIVIA 70 and 120 models, the insert in the selected color has a vertical grain, except for the toffee oak color. In other models, the inserts have horizontal grain.

## OPTIONS AVAILABLE WITH EXTRA CHARGE

- » glass pane MAT DRE, DECORMAT BROWN, DECORMAT GRAPHITE, (applies to door leaf)  
RIVIA 20, 30  
RIVIA 40, 50
- » white frost VSG 22.1 safe, complex glass pane  
RIVIA 20, 30  
RIVIA 40, 50
- » non-rebated door leaf
- » door leaf width "90" and "100"
- » ventilation undercut
- » recuperative undercutting -15mm
- » plastic ventilation grille
- » aluminum ventilation grille
- » **NOTE:** third Estetic 80 hinge for non-rebated doors (extra charge is added to the price of the door frame)

fig. 1

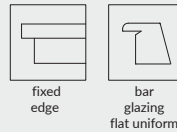
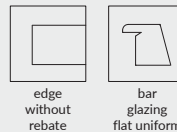

fig. 2





GALERIA ALU 20 - anthracite elm

DRE-Cell Decor	white matt	white (textured)	white pine	siberian elm	silver	sand oak	bleached oak textured	vintage oak	caramel walnut
	golden oak textured	walnut	anthracite elm	dark wenge	toffee oak***, **	marrone chestnut textured	evoke oak	light gray matt	
3D Decor	grand oak	elm	walnut american	ebony**	Polish oak 3D				
	white	milky white	ashen	gray dark	concrete 2	gray oak	welsh oak		
CPL Laminate *	acacia	celini walnut	walnut	honey oak	chestnut	roasted walnut	black ST		

\* laminate available in models 10, 20, 30, 50, 60

\*\*while stock last

\*\*\* decor available only in horizontal wood grain

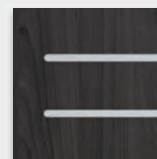

8mm inserts located in one plane with the door leaf surface on both sides

## STANDARD OPTIONS

- » door leaf frame made of softwood
- » core made of tubular chipboard
- » edge with radius R 2,5 mm used in 0,15-0,20 mm CPL laminates
- » decorative inserts 8 mm
- » glass pane white bark 4 mm thick

## OPTIONS WITHOUT EXTRA CHARGE

- » glass pane „chinchila” or „window blind”
- » ventilation sleeves
- » three hinges - applies to rebated door leaf

## REBATED DOOR LEAF

- » straight edge, flat glass pane frame **fig. 1**
- » 2 silver screw-in pivot hinges
- » single-point mortise simple key lock, bathroom lock, cylinder lock or economic lock
- » straight edge or edge with radius R 2,5 mm made in directforming (in CPL laminate) **fig 3**

## NON-REBATED DOOR LEAF (EXTRA CHARGE)

- » edge without rebate, flat glass pane frame **fig. 2**
- » sockets for 2 recessed Estetic 80 hinges (hinges constitute a part of the door frame)
- » magnetic simple key lock, bathroom lock, cylinder lock or economic lock

## SLIDING DOOR LEAF

- » edge without rebate, flat glass pane frame **fig. 2**
- » socket for hook lock and/or for handles

Note: passive door leaf GALERIA ALU 20, 21, 22, 23, 24, 25, 60 without horizontal inserts in a uniform grain.

NOTE: the Silent package applies to rebated and non-rebated single leaf door.

## OPTIONS AVAILABLE WITH EXTRA CHARGE

- » Silent package 37dB (dropping seal + acoustic insert) - GALERIA ALU 10 - 60
- » glass pane MAT DRE, DECORMAT BROWN, DECORMAT GRAPHITE, (applies to door leaf)  
GALERIA ALU 11, 13, 23  
GALERIA ALU 21  
GALERIA ALU 24, 25  
GALERIA ALU 12, 22
- » white frost VSG 22.1 safe, complex glass pane  
GALERIA ALU 11  
GALERIA ALU 13, 23  
GALERIA ALU 21  
GALERIA ALU 24  
GALERIA ALU 25  
GALERIA ALU 12  
GALERIA ALU 22
- » non-rebated door leaf
- » door leaf "90" and "100"
- » ventilation undercut
- » recuperative undercutting -15mm
- » plastic ventilation grille
- » aluminum ventilation grille
- » cover strip for non-rebated double leaf door
- » double leaf door leaf price x2
- » NOTE: third Estetic 80 hinge for non-rebated doors (extra charge is added to the price of the door frame)

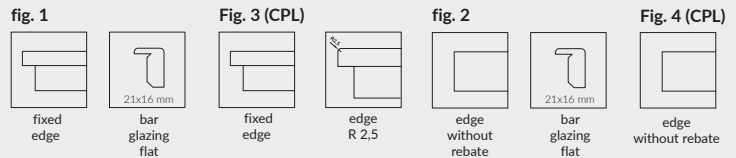

## STANDARD OPTIONS

- » door leaf frame made of softwood
- » core made of „honeycomb“
- » glass pane white bark 4 mm thick

## OPTIONS WITHOUT EXTRA CHARGE

- » glass pane „chinchila“ or „window blind“
- » ventilation sleeves
- » three hinges - applies to rebated door leaf

## REBATED DOOR LEAF

- » straight edge, flat glass pane frame **fig. 1**
- » 2 silver screw-in pivot hinges
- » single-point mortise simple key lock, bathroom lock, cylinder lock or economic lock

## NON-REBATED DOOR LEAF (EXTRA CHARGE)

- » edge without rebate, flat glass pane frame , **fig. 2**
- » sockets for 2 recessed Estetic 80 hinges (hinges constitute a part of the door frame)
- » magnetic simple key lock, bathroom lock, cylinder lock or economic lock

## SLIDING DOOR LEAF

- » edge without rebate, flat glass pane frame **fig. 2**
- » socket for hook lock and/or for handles

## OPTIONS AVAILABLE WITH EXTRA CHARGE

- » glass pane MAT DRE, DECORMAT BROWN, DECORMAT GRAPHITE (applies to the door leaf) ARTE B 10, 20, 30 ARTE B 40, 50 ARTE B 60
- » white frost VSG 22.1 safe, complex glass pane ARTE B 10, 20, 30 ARTE B 40, 50 ARTE B 60
- » stabilising insert tubular chipboard
- » non-rebated door leaf
- » door leaf "90" and "100"
- » ventilation undercut
- » recuperative undercutting -15mm
- » plastic ventilation grille
- » aluminum ventilation grille
- » cover strip for non-rebated double leaf door
- » double leaf door leaf price x2
- » **NOTE:** third Estetic 80 hinge for non-rebated doors (extra charge is added to the price of the door frame)

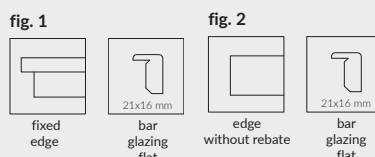

DRE-Cell Decor	white matt	white (textured)	white pine	siberian elm	silver	sand oak	bleached oak textured	vintage oak	caramel walnut
	golden oak textured	walnut	anthracite elm	dark wenge	toffee oak*** *	marrone chestnut textured	light gray matt	evoked oak	
3D Decor	grand oak	elm	walnut american	ebony*	Polish oak 3D	*** decor available only in horizontal wood grain *while stock last			

### STANDARD OPTIONS

- » door leaf frame made of softwood
- » core made of „honeycomb“
- » glass pane white bark 4 mm thick

### OPTIONS WITHOUT EXTRA CHARGE

- » glass pane „chinchila“ or „window blind“
- » ventilation sleeves
- » three hinges - applies to rebated door leaf

### REBATED DOOR LEAF

- » straight edge, flat glass pane frame, 19 mm MDF profiled panels **fig. 1**
- » 2 silver screw-in pivot hinges
- » single-point mortise simple key lock, bathroom lock, cylinder lock or economic lock

### NON-REBATED DOOR LEAF (EXTRA CHARGE)

- » edge without rebate, flat glass pane frame, 19 mm MDF profiled panels **fig. 2**
- » sockets for 2 recessed Estetic 80 hinges (hinges constitute a part of the door frame)
- » magnetic simple key lock, bathroom lock, cylinder lock or economic lock

### SLIDING DOOR LEAF

- » edge without rebate, flat glass pane frame, 19 mm MDF profiled panels **fig. 2**
- » socket for hook lock and/or for handles

### OPTIONS AVAILABLE WITH EXTRA CHARGE

- » glass pane MAT DRE, DECORMAT BROWN, DECORMAT GRAPHITE (applies to door leaf)  
CARLA 20  
CARLA 30  
CARLA 40
- » white frost VSG 22.1 safe, complex glass pane  
CARLA 20  
CARLA 30  
CARLA 40
- » stabilising insert tubular chipboard
- » non-rebated door leaf
- » door leaf "90" and "100"
- » ventilation undercut
- » recuperative undercutting -15mm
- » plastic ventilation grille
- » aluminum ventilation grille
- » cover strip for non-rebated double leaf door
- » double leaf door leaf price x2
- » **NOTE:** third Estetic 80 hinge for non-rebated doors (extra charge is added to the price of the door frame)

fig. 1



fig. 2



white matt	white (textured)	white pine	siberian elm	silver	sand oak	bleached oak textured	vintage oak	caramel walnut	DRE-Cell Decor	
golden oak textured	walnut	anthracite elm	dark wenge	toffee oak***, *	marrone chestnut textured	light gray matt	evoke oak			
*** decor available only in horizontal wood grain					grand oak	elm	walnut american	ebony*	Polish oak 3D	3D Decor

\*while stock last



## FINEA 40 vintage oak

DRE-Cell Decor	white matt	white (textured)	white pine	siberian elm	silver	sand oak	bleached oak textured	vintage oak	caramel walnut
	golden oak textured	walnut	anthracite elm	dark wenge	toffee oak***, *	marrone chestnut textured	light gray matt	evoke oak	
3D Decor	grand oak	elm	walnut american	ebony*	Polish oak 3D				

\*while stock last

\*\*\* decor available only in horizontal wood grain



## STANDARD OPTIONS

- » door leaf frame made of softwood
- » core made of tubular chipboard
- » glass pane white bark 4 mm thick

## OPTIONS WITHOUT EXTRA CHARGE

- » glass pane „chinchila” or „window blind”
- » ventilation sleeves
- » three hinges - applies to rebated door leaf

## REBATED DOOR LEAF

- » straight edge, flat glass pane frame **fig. 1**
- » 2 silver screw-in pivot hinges
- » single-point mortise simple key lock, bathroom lock, cylinder lock or economic lock

## NON-REBATED DOOR LEAF (EXTRA CHARGE)

- » edge without rebate, flat glass pane frame **fig. 2**
- » sockets for 2 recessed Estetic 80 hinges (hinges constitute a part of the door frame)
- » magnetic simple key lock, bathroom lock, cylinder lock or economic lock

## SLIDING DOOR LEAF

- » edge without rebate, flat glass pane frame **fig. 2**
- » socket for hook lock and/or for handles

## OPTIONS AVAILABLE WITH EXTRA CHARGE

- » glass pane MAT DRE, DECORMAT BROWN, DECORMAT GRAPHITE (applies to door leaf) FINEA 20, FINEA B 20, FINEA 30, 50, 60, FINEA B 30, 50, 60
- » white frost VSG 22.1 safe, complex glass pane FINEA 20, FINEA B 20, FINEA 30, FINEA B 30, FINEA 50, 60, FINEA B 50, 60
- » non-rebated door leaf
- » door leaf width "90" and "100"
- » ventilation undercut
- » recuperative undercutting -15mm
- » plastic ventilation grille
- » aluminum ventilation grille
- » **NOTE:** third Estetic 80 hinge for non-rebated doors (extra charge is added to the price of the door frame)

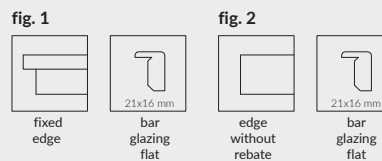

FINEA 10  
FINEA B 10\*

FINEA 20  
FINEA B 20\*

FINEA 30  
FINEA B 30\*

FINEA 40  
FINEA B 40\*

FINEA 50  
FINEA B 50\*

FINEA 60  
FINEA B 60\*

\* FINEA B panels available only with horizontal wood grain



panels wood grain in FINEA



panels horizontal wood grain  
FINEA B



DECO 20 - concrete 2 with a black SLIM frame

DRE-Cell Decor	white matt	white (textured)	white pine	siberian elm	silver	sand oak	bleached oak textured	vintage oak	caramel walnut
	golden oak textured	walnut	anthracite elm	dark wenge	toffee elm***, *	marrone chestnut textured	light gray matt	evoke oak	
3D Decor	grand oak	elm	walnut american	ebony*	Polish oak 3D				
CPL Laminate	white	milky white	ashen	gray dark	concrete 2	gray oak	welsh oak		
	acacia	celini walnut	walnut	honey oak	chestnut	roasted walnut	black ST		

\*\*\* decor available only in horizontal wood grain

\*while stock last

**STANDARD OPTIONS**

- » door leaf frame made of softwood
- » edge radius R 2.5 mm for CPL laminates 0.15-0.2 mm except for white, milky white, gray
- » core made of „honeycomb“
- » glass pane white bark 4 mm thick
- » flat 4mm HDF panel in DECO 40

**OPTIONS WITHOUT EXTRA CHARGE**

- » glass pane „chinchila“ or „window blind“
- » ventilation sleeves
- » three hinges - applies to rebated door leaf

**REBATED DOOR LEAF**

- » straight edge, flat glass pane frame **Fig. 1** in the leaf decor or black Slim
- » 2 silver screw-in pivot hinges
- » single-point mortise simple key lock, bathroom lock, cylinder lock or economic lock
- » rounded glass pane frame, straight edge or edge with radius R 2,5 mm made in directforming (in CPL laminate)

**NON-REBATED DOOR LEAF (EXTRA CHARGE)**

- » non-rebated edge, flat glass pane frame **Fig. 2** in the leaf decor or black Slim
- » sockets for 2 recessed Estetic 80 hinges (hinges constitute a part of the door frame)
- » magnetic simple key lock, bathroom lock, cylinder lock or economic lock
- » edge without rebate, rounded glass pane frame (in CPL laminate) **fig. 5**

**SLIDING DOOR LEAF**

- » non-rebated edge and a choice of: flat glass pane frame in the leaf decor or black Slim, **fig. 2** or a rounded glass pane frame **fig. 3**
- » socket for hook lock and/or for handles
- » edge without rebate, rounded glass pane frame (in CPL laminate) **fig. 5**

**OPTIONS AVAILABLE WITH EXTRA CHARGE**

- » glass pane MAT DRE, DECORMAT BROWN , DECORMAT GRAPHITE (applies to door leaf) DECO 10, 20, 30
- » white frost VSG 22.1 safe, complex glass pane DECO 10, 20, 30
- » stabilising insert tubular chipboard
- » non-rebated door leaf
- » door leaf "90" and "100"
- » ventilation undercut
- » recuperative undercutting -15mm
- » plastic ventilation grille
- » aluminum ventilation grille
- » cover strip for non-rebated double leaf door
- » double leaf door leaf price x2
- » **NOTE:** third Estetic 80 hinge for non-rebated doors (extra charge is added to the price of the door frame)

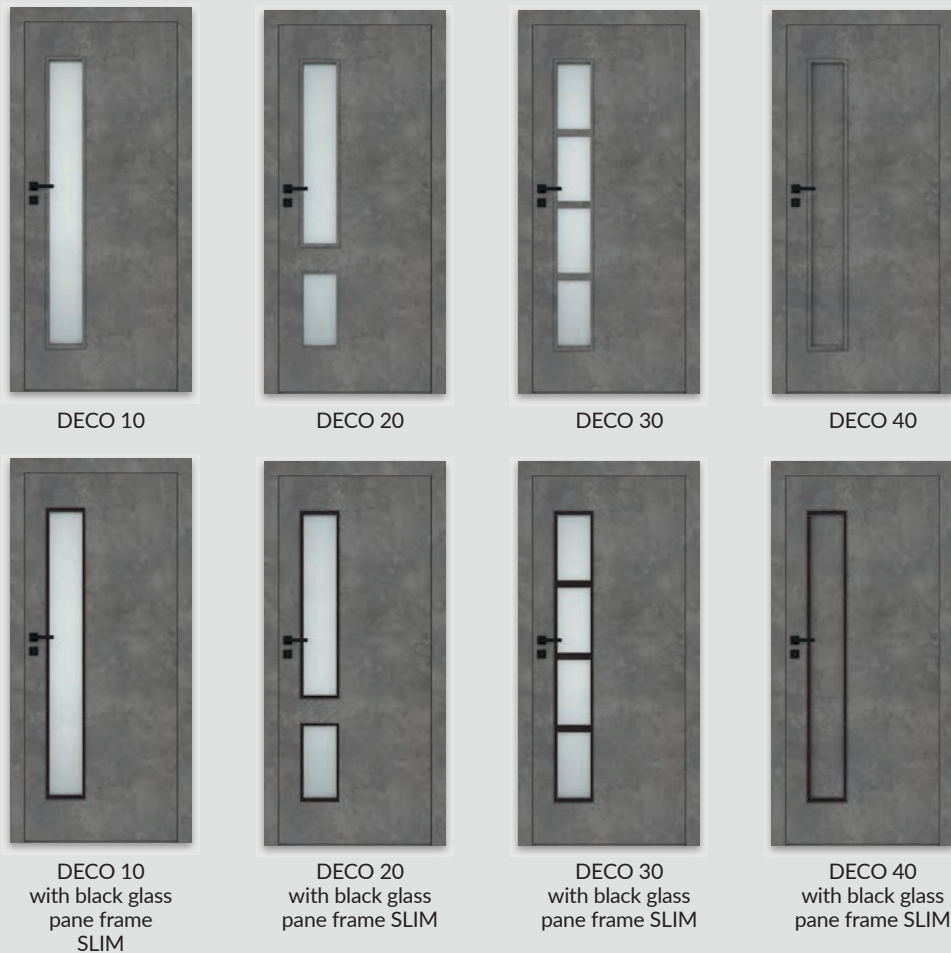
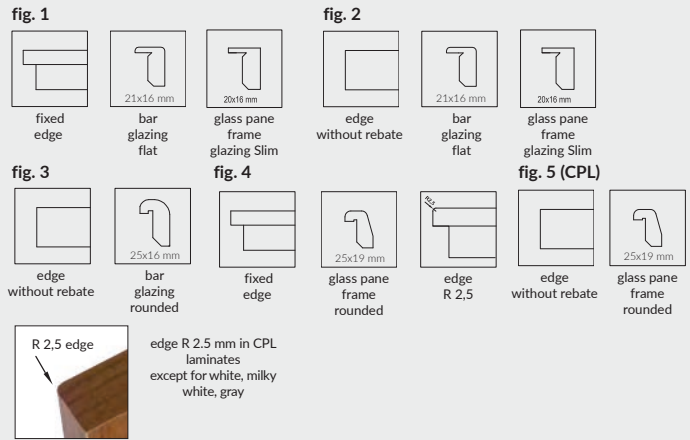



MODERN 20 - white matt

DRE-Cell Decor	white matt	white (textured)	white pine	siberian elm	silver	sand oak	bleached oak textured	vintage oak	caramel walnut
	golden oak textured	walnut	anthracite elm	dark wenge	toffee elm***	marrone chestnut textured	light gray matt	evoke oak	
3D Decor	grand oak	elm	walnut american	ebony*	Polish oak 3D				

\*\*\* decor available only in horizontal wood grain

\*while stock last

## STANDARD OPTIONS

- » door leaf frame made of softwood
- » core made of „honeycomb“
- » glass pane white bark 4 mm thick

## OPTIONS WITHOUT EXTRA CHARGE

- » glass pane „chinchila“ or „window blind“
- » ventilation sleeves
- » three hinges - applies to rebated door leaf

## REBATED DOOR LEAF

- » straight edge, flat glass pane frame in the door leaf decor or black Slim, flat HDF panels, thickness 4 mm **fig. 1**
- » 2 silver screw-in pivot hinges
- » single-point mortise simple key lock, bathroom lock, cylinder lock or economic lock

## NON-REBATED DOOR LEAF (EXTRA CHARGE)

- » non-rebated edge, flat glass pane frame in the door leaf decor or black Slim, flat HDF panels, thickness 4 mm **fig. 2**
- » sockets for 2 recessed Estetic 80 hinges (hinges constitute a part of the door frame)
- » magnetic simple key lock, bathroom lock, cylinder lock or economic lock

## SLIDING DOOR LEAF

- » non-rebated edge and a choice of: flat glass pane frame in the door leaf decor or black Slim, flat HDF panels, thickness 4 mm **fig. 2** or a rounded glass pane frame, profiled MDF panels, thickness 19 mm **fig. 3**
- » socket for hook lock and/or for handles

## OPTIONS AVAILABLE WITH EXTRA CHARGE

- » glass pane MAT DRE, DECORMAT BROWN, DECORMAT GRAPHITE, (applies to door leaf) MODERN 20  
MODERN 30  
MODERN 40  
MODERN 50
- » white frost VSG 22.1 safe, complex glass pane  
MODERN 20  
MODERN 30  
MODERN 40  
MODERN 50
- » stabilising insert tubular chipboard
- » non-rebated door leaf
- » door leaf "90" and "100"
- » ventilation undercut
- » recuperative undercutting -15mm
- » plastic ventilation grille
- » aluminum ventilation grille
- » cover strip for non-rebated double leaf door
- » double leaf door leaf price x2
- » **NOTE:** third Estetic 80 hinge for non-rebated doors (extra charge is added to the price of the door frame)

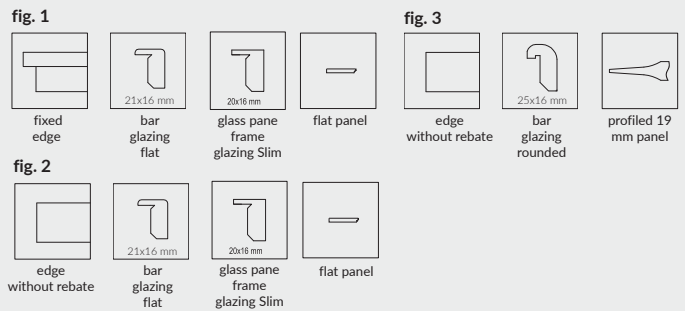

MODERN 10



MODERN 20



MODERN 30



MODERN 40

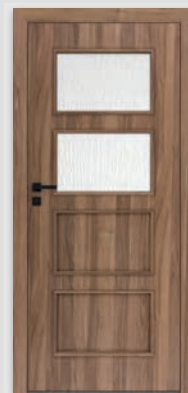

MODERN 50



MODERN 10  
with black glass  
pane frame SLIM



MODERN 20  
with black glass  
pane frame SLIM



MODERN 30  
with black glass  
pane frame SLIM



MODERN 40  
with black glass  
pane frame SLIM



MODERN 50  
with black glass  
pane frame SLIM



KANON 10 - American walnut, black glass pane frames

DRE-Cell Decor	white matt	white (textured)	white pine	siberian elm	silver	sand oak	bleached oak textured	vintage oak	caramel walnut
	golden oak textured	walnut	anthracite elm	dark wenge	toffee oak***, *	marrone chestnut textured	light gray matt	evoke oak	
3D Decor	grand oak	elm	walnut american	ebony*	Polish oak 3D				

\*\*\* decor available only in horizontal wood grain

\*while stock last

### STANDARD OPTIONS

- » door leaf frame made of softwood
- » core made of „honeycomb“
- » glass pane white bark 4 mm thick

### OPTIONS WITHOUT EXTRA CHARGE

- » glass pane „chinchila“ or „window blind“
- » ventilation sleeves
- » three hinges - applies to rebated door leaf

### REBATED DOOR LEAF

- » straight edge, flat glass pane frame in the door leaf decor or black Slim, flat HDF panels, thickness 4 mm **fig. 1**
- » 2 silver screw-in pivot hinges
- » single-point mortise simple key lock, bathroom lock, cylinder lock or economic lock

### NON-REBATED DOOR LEAF (EXTRA CHARGE)

- » non-rebated edge, flat glass pane frame in the door leaf decor or black Slim, flat HDF panels, thickness 4 mm **fig. 2**
- » sockets for 2 recessed Estetic 80 hinges (hinges constitute a part of the door frame)
- » magnetic simple key lock, bathroom lock, cylinder lock or economic lock

### SLIDING DOOR LEAF

- » non-rebated edge and a choice of: flat glass pane frame in the door leaf decor or black Slim, flat HDF panels, thickness 4 mm **fig. 2** or a rounded glass pane frame, profiled MDF panels, thickness 19 mm **fig. 3**
- » socket for hook lock and/or for handles

### OPTIONS AVAILABLE WITH EXTRA CHARGE

- » glass pane MAT DRE, DECORMAT BROWN, DECORMAT GRAPHITE, (applies to door leaf) KANON 20  
KANON 30  
KANON 40
- » white frost VSG 22.1 safe, complex glass pane  
KANON 20  
KANON 30  
KANON 40
- » stabilising insert tubular chipboard
- » non-rebated door leaf
- » door leaf "90" and "100"
- » ventilation undercut
- » recuperative undercutting -15mm
- » plastic ventilation grille
- » aluminum ventilation grille
- » cover strip for non-rebated double leaf door
- » double leaf door leaf price x2
- » **NOTE:** third Estetic 80 hinge for non-rebated doors (extra charge is added to the price of the door frame)

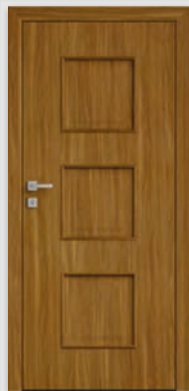
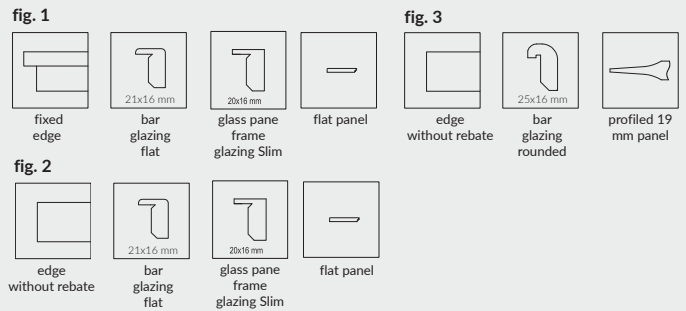

KANON 10



KANON 20

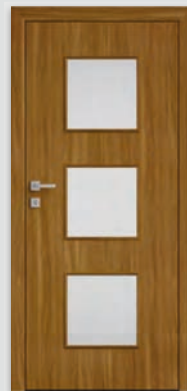

KANON 30

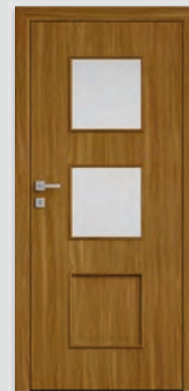

KANON 40

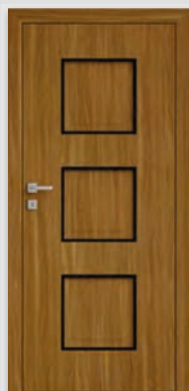

KANON 10  
with black glass  
pane frame  
SLIM

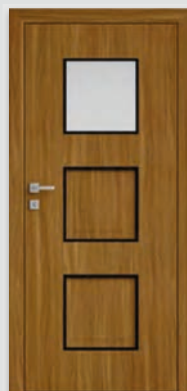

KANON 20  
with black glass  
pane frame  
SLIM

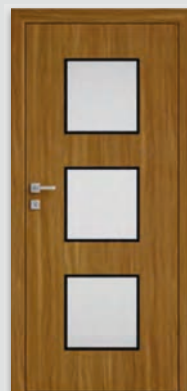

KANON 30  
with black glass  
pane frame SLIM

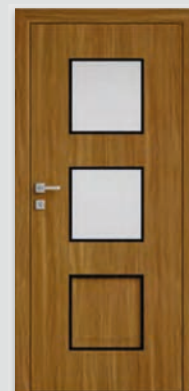

KANON 40  
with black glass  
pane frame SLIM



PLUS 30 - white matt

DRE-Cell Decor	white matt	white (textured)	white pine	siberian elm	silver	sand oak	bleached oak textured	vintage oak	caramel walnut
	golden oak textured	walnut	anthracite elm	dark wenge	toffee oak***, *	marrone chestnut textured	light gray matt	evoked oak	
3D Decor	grand oak	elm	walnut american	ebony*	Polish oak 3D				

\*\*\* decor available only in horizontal wood grain

\*while stock last



### STANDARD OPTIONS

- » door leaf frame made of softwood
- » core made of „honeycomb“
- » glass pane white bark 4 mm thick

### OPTIONS WITHOUT EXTRA CHARGE

- » glass pane „chinchila“ or „window blind“
- » ventilation sleeves
- » three hinges - applies to rebated door leaf

### REBATED DOOR LEAF

- » edge without rebate, flat glass pane frame, flat 4 mm HDF panels fig. 1
- » 2 silver screw-in pivot hinges
- » single-point mortise simple key lock, bathroom lock, cylinder lock or economic lock

### NON-REBATED DOOR LEAF (EXTRA CHARGE)

- » edge without rebate, flat glass pane frame, flat 4 mm HDF panels fig. 2
- » sockets for 2 recessed Estetic 80 hinges (hinges constitute a part of the door frame)
- » magnetic simple key lock, bathroom lock, cylinder lock or economic lock

### SLIDING DOOR LEAF

- » edge without rebate, flat 4 mm HDF panels and optional: flat glass pane frame, fig. 2 or rounded glass pane frame fig. 3
- » socket for hook lock and/or for handles

### OPTIONS AVAILABLE WITH EXTRA CHARGE

- » glass pane MAT DRE, DECORMAT BROWN, DECORMAT GRAPHITE (applies to door leaf) PLUS 20 PLUS 40, 50, 60, 70, 80 PLUS 30
- » white frost VSG 22.1 safe, complex glass pane PLUS 20 PLUS 30 PLUS 40 PLUS 70, 80
- » stabilising insert tubular chipboard
- » non-rebated door leaf
- » door leaf "90" and "100"
- » ventilation undercut
- » recuperative undercutting -15mm
- » plastic ventilation grille
- » aluminum ventilation grille
- » cover strip for non-rebated double leaf door
- » double leaf door leaf price x2
- » **NOTE:** third Estetic 80 hinge for non-rebated doors (extra charge is added to the price of the door frame)

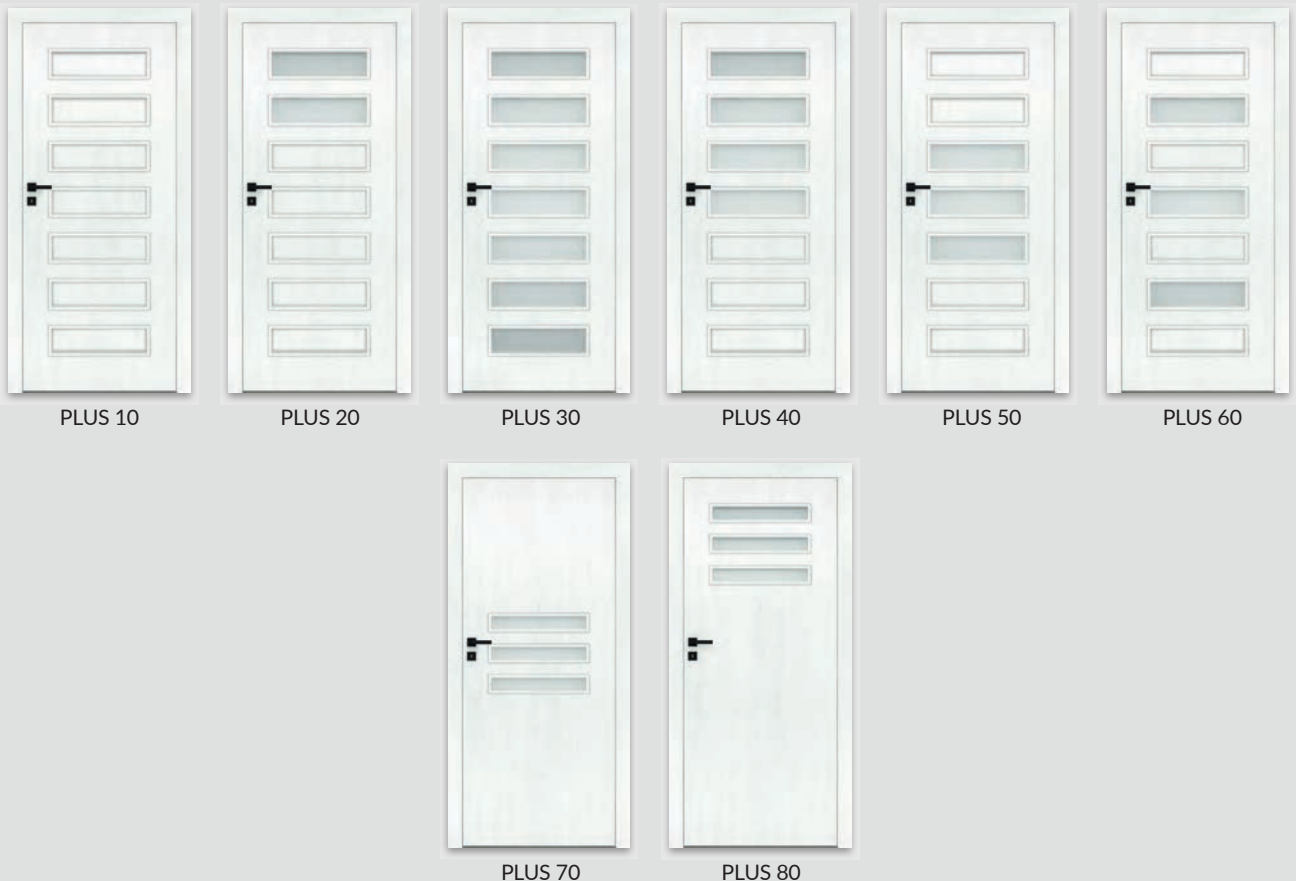
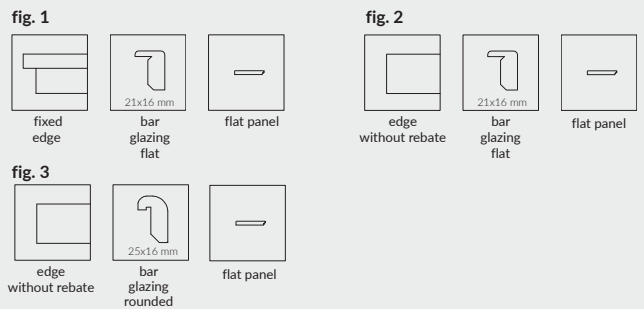



## STANDARD 10 - evoke oak

DRE-Cell Decor	white matt	white (textured)	white pine	siberian elm	silver	sand oak	bleached oak textured	vintage oak	caramel walnut
	golden oak textured	walnut	anthracite elm	dark wenge	toffee oak***, *	marrone chestnut textured	light gray matt	evoke oak	
3D Decor	grand oak	elm	walnut american	ebony*	Polish oak 3D				

\*\*\* decor available only in horizontal wood grain

\*while stock last

## STANDARD OPTIONS

- » door leaf frame made of softwood
- » core made of „honeycomb”
- » glass pane white bark 4 mm thick

## OPTIONS WITHOUT EXTRA CHARGE

- » glass pane „chinchila” or „window blind”
- » ventilation sleeves
- » three hinges - applies to rebated door leaf

## REBATED DOOR LEAF

- » straight edge, flat glass pane frame **fig. 1**
- » 2 silver screw-in pivot hinges
- » single-point mortise simple key lock, bathroom lock, cylinder lock or economic lock
- » **Realization of orders in the investment standard after consultation with the Contracts Department. The investment standard is a door frame passage with a leaf open at an angle of 90° for interior doors: "80" 800 mm, "90" 900 mm.**

## NON-REBATED DOOR LEAF (EXTRA CHARGE)

- » edge without rebate, flat glass pane frame **fig. 2**
- » sockets for 2 recessed Estetic 80 hinges (hinges constitute a part of the door frame)
- » magnetic simple key lock, bathroom lock, cylinder lock or economic lock

## SLIDING DOOR LEAF

- » edge without rebate and optional: flat glass pane frame fig.2 or rounded glass pane frame fig. 3
- » socket for hook lock and/or for handles

**NOTE:** the Silent package applies to rebated and non-rebated single leaf door.

## OPTIONS AVAILABLE WITH EXTRA CHARGE

- » Silent package 37dB (dropping seal + acoustic insert) - STANDARD 10
- » glass pane MAT DRE, DECORMAT BROWN, DECORMAT GRAPHITE (applies to door leaf) STANDARD 20, 20s, 40, 40s, BULAJ MDF STANDARD 50, 50s STANDARD 30, 30s STANDARD 60
- » white frost VSG 22.1 safe, complex glass pane STANDARD 20, 20s, 40, 40s STANDARD 50, 50s, MDF BULAJ STANDARD 30, 30s STANDARD 60
- » stabilising insert tubular chipboard
- » non-rebated door leaf
  - » door leaf "90" and "100"
  - » rebated door leaf "110" ( only STANDARD 10)
- » additional upper single point mortise lock (available only in STANDARD 10 door leaf model with core made of perforated chipboard and fixed door frame)
- » ventilation undercut
- » recuperative undercutting -15mm
- » plastic ventilation grille
- » aluminum ventilation grille
- » cover strip for non-rebated double leaf door
- » double leaf door door leaf price x 2
- » there is possibility to purchase steel BULAJ separately in black or steel colour
- » **NOTE:** third Estetic 80 hinge for non-rebated doors (extra charge is added to the price of the door frame)

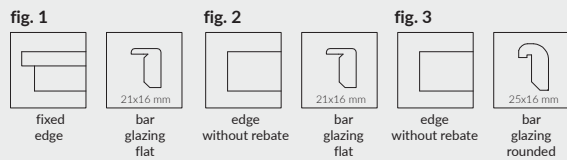

additional upper single point mortise lock (available only in STANDARD 10 door leaf model with core made of perforated chipboard and fixed door frame)

black steel Bulaj \*  
steel Bulaj \*  
\* only MATT or transparent glass pane available



## FANO 10 - elm

DRE-Cell Decor	white matt	white (textured)	white pine	siberian elm	silver	sand oak	bleached oak textured	vintage oak	caramel walnut
	golden oak textured	walnut	anthracite elm	dark wenge	toffee oak***, *	marrone chestnut textured	light gray matt	evoked oak	
3D Decor	grand oak	elm	walnut american	ebony*	Polish oak 3D				

\*\*\* decor available only in horizontal wood grain

\*while stock last

### STANDARD OPTIONS

- » door leaf frame made of softwood
- » core made of „honeycomb”
- » glass pane white bark 4 mm thick

### OPTIONS WITHOUT EXTRA CHARGE

- » glass pane „chinchila” or „window blind”
- » ventilation sleeves
- » three hinges - applies to rebated door leaf

### REBATED DOOR LEAF

- » straight edge, flat glass pane frame **fig. 1**
- » 2 silver screw-in pivot hinges
- » single-point mortise simple key lock, bathroom lock, cylinder lock or economic lock

### NON-REBATED DOOR LEAF (EXTRA CHARGE)

- » edge without rebate, flat glass pane frame, 19 mm MDF profiled panels **fig. 2**
- » sockets for 2 recessed Estetic 80 hinges (hinges constitute a part of the door frame)
- » magnetic simple key lock, bathroom lock, cylinder lock or economic lock

### SLIDING DOOR LEAF

- » edge without rebate, rounded glass pane frame or flat glass pane frame, profiled 19 mm MDF panel **fig. 3**
- » socket for hook lock and/or for handles

### OPTIONS AVAILABLE WITH EXTRA CHARGE

- » glass pane MAT DRE, DECORMAT BROWN, DECORMAT GRAPHITE (applies to door leaf) FANO 20, 20s FANO 30, 30s
- » white frost VSG 22.1 safe, complex glass pane FANO 20, 20s FANO 30, 30s
- » stabilising insert tubular chipboard
- » non-rebated door leaf
- » door leaf "90" and "100"
- » ventilation undercut
- » recuperative undercutting -15mm
- » plastic ventilation grille
- » aluminum ventilation grille
- » cover strip for non-rebated double leaf door
- » double leaf door leaf price x2
- » **NOTE:** third Estetic 80 hinge for non-rebated doors (extra charge is added to the price of the door frame)

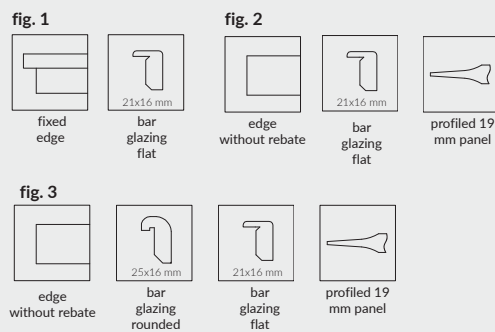



ARTE 40 - sand oak

DRE-Cell Decor	white matt	white (textured)	white pine	siberian elm	silver	sand oak	bleached oak textured	vintage oak	caramel walnut
	golden oak textured	walnut	anthracite elm	dark wenge	toffee oak***, *	marrone chestnut textured	light gray matt	evoke oak	
3D Decor	grand oak	elm	walnut american	ebony*	Polish oak 3D				

\*\*\* decor available only in horizontal wood grain

\*while stock last

### STANDARD OPTIONS

- » door leaf frame made of softwood
- » core made of „honeycomb“
- » glass pane white bark 4 mm thick

### OPTIONS WITHOUT EXTRA CHARGE

- » glass pane „chinchila“ or „window blind“
- » ventilation sleeves
- » three hinges - applies to rebated door leaf

### REBATED DOOR LEAF

- » straight edge, flat glass pane frame **fig. 1**
- » 2 silver screw-in pivot hinges
- » single-point mortise simple key lock, bathroom lock, cylinder lock or economic lock

### NON-REBATED DOOR LEAF (EXTRA CHARGE)

- » edge without rebate, flat glass pane frame **fig. 2**
- » sockets for 2 recessed Estetic 80 hinges (hinges constitute a part of the door frame)
- » magnetic simple key lock, bathroom lock, cylinder lock or economic lock

### SLIDING DOOR LEAF

- » edge without rebate, rounded glass pane frame or flat glass pane frame **fig. 3**
- » socket for hook lock and/or for handles

### OPTIONS AVAILABLE WITH EXTRA CHARGE

- » glass pane MAT DRE, DECORMAT BROWN, DECORMAT GRAPHITE (applies to door leaf) ARTE 10-30, 90 ARTE 40, 50 ARTE 80
- » white frost VSG 22.1 safe, complex glass pane ARTE 10, 20, 30 ARTE 40, 50 ARTE 80 ARTE 90
- » stabilising insert tubular chipboard
- » non-rebated door leaf
- » door leaf "90" and "100"
- » ventilation undercut
- » recuperative undercutting -15mm
- » plastic ventilation grille
- » aluminum ventilation grille
- » cover strip for non-rebated double leaf door
- » double leaf door leaf price x2
- » **NOTE:** third Estetic 80 hinge for non-rebated doors (extra charge is added to the price of the door frame)

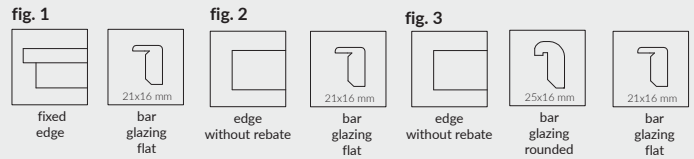



## UNI 10 - ashen

Decor



white acrylic UV varnish - RAL 9003  
ecru - RAL 9001  
latte - Flugger 4362, NCS S1505-Y50R  
ashen - RAL 7035



### STANDARD OPTIONS

- » door leaf painted with acrylic UV varnish
- » door leaf frame made of MDF
- » core made of „honeycomb”
- » glass pane white bark 4 mm thick

### OPTIONS WITHOUT EXTRA CHARGE

- » glass pane „chinchila” or „window blind”
- » ventilation sleeves
- » third hinge to rebated door leaf

**NOTE:** To ensure highest quality of painted products, before painting process, both, door leaf and door frames are coated with special material which constitutes solid base.

### REBATED DOOR LEAF

- » straight edge **fig. 1**
- » 2 silver screw-in pivot hinges
- » single-point mortise simple key lock, bathroom lock, cylinder lock or economic lock

### NON-REBATED DOOR LEAF (EXTRA CHARGE)

- » edge without rebate **fig. 2**
- » sockets for 2 recessed Estetic 80 hinges (hinges constitute a part of the door frame)
- » magnetic simple key lock, bathroom lock, cylinder insert lock or economic lock in steel, black or white color

### SLIDING DOOR LEAF

- » edge without rebate **fig. 2**
- » socket for hook lock and/or for handles

\* Note: selected configurations of white rebated UNI 10 model are available from stock.

**NOTE:** the Silent package applies to rebated and non-rebated single leaf door.

### DOOR LEAF WITH INVERTED REBATE (extra charge)

- » active single leaf door
- » straight edge **fig 3**
- » sockets for two recessed Estetic 1821 hinges (hinges constitute a part of the door frame)
- » magnetic simple key lock, bathroom lock, cylinder lock or economic lock

### OPTIONS AVAILABLE WITH EXTRA CHARGE

- » Silent 37dB package (dropping seal + acoustic insert) - UNI 10
- » glass pane MAT DRE, DECORMAT BROWN, DECORMAT GRAPHITE (applies to door leaf BULAJ MDF)
- » white frost VSG 22.1 safe, complex glass pane BULAJ MDF
- » stabilising insert tubular chipboard
- » core made of full chipboard
- » door leaf "90" and "100"
- » ventilation undercut
- » recuperative undercutting -15mm
- » non-rebated door leaf
- » door leaf with inverted rebate
- » cover strip for non-rebated double leaf door
- » plastic ventilation grille
- » aluminum ventilation grille
- » double leaf door leaf price x2
- » there is possibility to purchase steel BULAJ separately in black or steel colour
- » **NOTE:** third Estetic 80 hinge for non-rebated doors (extra charge is added to the price of the door frame)

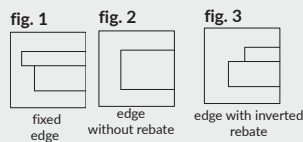

\* only MATT or transparent glass pane available



## FARGO 10 - ashen

Decor



white acrylic UV varnish - RAL 9003  
ecru - RAL 9001  
latte - Flugger 4362, NCS S1505-Y50R  
ashen - RAL 7035

## STANDARD OPTIONS

- » door leaf painted with acrylic UV varnish
- » door leaf frame made of MDF
- » core made of „honeycomb”

## OPTIONS WITHOUT EXTRA CHARGE

- » ventilation sleeves
- » three hinges - applies to rebated door leaf

**NOTE:** To ensure highest quality of painted products, before painting process, both, door leaf and door frames are coated with special material which constitutes solid base.

## REBATED DOOR LEAF

- » straight edge **fig. 1**
- » 2 silver screw-in pivot hinges
- » single-point mortise simple key lock, bathroom lock, cylinder lock or economic lock

## NON-REBATED DOOR LEAF (EXTRA CHARGE)

- » edge without rebate **fig. 2**
- » sockets for 2 recessed Estetic 80 hinges (hinges constitute a part of the door frame)
- » magnetic simple key lock, bathroom lock, cylinder insert lock or economic lock in steel, black or white color

## SLIDING DOOR LEAF

- » edge without rebate **fig. 2**
- » socket for hook lock and/or for handles

## DOOR LEAF WITH INVERTED REBATE (extra charge)

- » active single leaf door
- » straight edge **fig 3**
- » sockets for two recessed Estetic 1821 hinges (hinges constitute a part of the door frame)
- » magnetic simple key lock, bathroom lock, cylinder lock or economic lock

## OPTIONS AVAILABLE WITH EXTRA CHARGE

- » Silent package 37dB (dropping seal + acoustic insert) - FARGO 10 - 60
- » door leaf "90" and "100"
- » tubular chipboard
- » core made of full chipboard
- » ventilation undercut
- » recuperative undercutting -15mm
- » non-rebated door leaf
- » door leaf with inverted rebate
- » cover strip for non-rebated double leaf door
- » plastic ventilation grille
- » aluminum ventilation grille
- » double leaf door

**NOTE:** third Estetic 80 hinge for non-rebated doors (extra charge is added to the price of the door frame) leaf price x2

**NOTE:** the Silent package applies to rebated and non-rebated single leaf door.

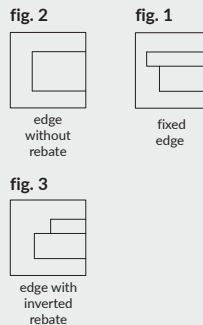

milling type in FARGO collection





**BINITO 20 white acrylic UV lacquer**

Decor



white acrylic UV varnish - RAL 9003  
 ecru - RAL 9001  
 latte - Flugger 4362, NCS S1505-Y50R  
 ashen - RAL 7035

**DOOR HANDLE WITH A BACKPLATE**

The promotion applies to rebated and non-rebated active door leaves from BINITO collection. Door handle model and finishing color to be chosen from: WEGA, ATRIA, ARCTUS and ORION door handles and a backplate with a simple key or a cylinder or a bathroom lock. The promotion lasts while stocks last.



types of milling in BINITO collection

## STANDARD OPTIONS

- » door leaf painted with acrylic UV varnish
- » door leaf frame made of MDF
- » core made of „honeycomb“
- » glass pane white bark 4 mm thick

## OPTIONS WITHOUT EXTRA CHARGE

- » glass pane „chinchila“ or „window blind“
- » ventilation sleeves
- » three hinges - applies to rebated door leaf

**NOTE:** To ensure highest quality of painted products, before painting process, both, door leaf and door frames are coated with special material which constitutes solid base.

## REBATED DOOR LEAF

- » straight edge, flat glass pane frame **fig. 1**
- » 2 silver screw-in pivot hinges
- » single-point mortise simple key lock, bathroom lock, cylinder lock or economic lock

## NON-REBATED DOOR LEAF (EXTRA CHARGE)

- » edge without rebate, flat glass pane frame **fig. 2**
- » sockets for 2 recessed Estetic 80 hinges (hinges constitute a part of the door frame)
- » magnetic simple key lock, bathroom lock, cylinder insert lock or economic lock in steel, black or white color

## SLIDING DOOR LEAF

- » edge without rebate, flat glass pane frame **fig. 2**
- » socket for hook lock and/or for handles

## DOOR LEAF WITH INVERTED REBATE (extra charge)

- » active single leaf door
- » straight edge **fig. 3**
- » sockets for two recessed Estetic 1821 hinges (hinges constitute a part of the door frame)
- » magnetic simple key lock, bathroom lock, cylinder lock or economic lock

## OPTIONS AVAILABLE WITH EXTRA CHARGE

- » Silent package 37dB (dropping seal + acoustic insert) - BINITO 10 - 90
- » glass pane MAT DRE, DECORMAT BROWN, DECORMAT GRAPHITE BINITO 11, 23  
BINITO 21, 100  
BINITO 24, 110
- » white frost VSG 22.1 safe, complex glass pane  
BINITO 11  
BINITO 23  
BINITO 21, 100  
BINITO 24  
BINITO 110
- » door leaf "90" and "100"
- » tubular chipboard
- » core made of full chipboard
- » non-rebated door leaf
- » ventilation undercut
- » recuperative undercutting -15mm
- » door leaf with inverted rebate
- » cover strip for non-rebated double leaf door
- » plastic ventilation grille
- » aluminum ventilation grille
- » double leaf door leaf price x2
- » **NOTE:** third Estetic 80 hinge for non-rebated doors (extra charge is added to the price of the door frame)

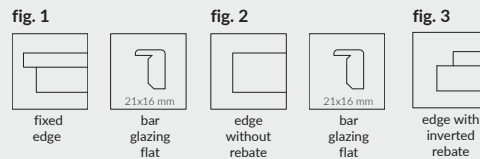

**NOTE:** the Silent package applies to rebated and non-rebated single leaf door.



\* Note: selected configurations of the BINITO 20 model are available as stock orders, rebated in white matt.

Door leaves width: single leaf door „60“÷„100“, rebated double leaf door „120“ ÷ „200“, non-rebated double leaf door „120“ ÷ „180“.  
Technical information: door frames: pp. 136-159, accessories: pp. 160-167 and 177, door leaves: pp. 178-186.



BULAJ INVEST metal - honey oak

CPL laminate 1st group	milky white	white	ashen								
CPL Laminate 2nd group	gray dark	concrete 2	gray oak	welsh oak	acacia	celini walnut	walnut	honey oak	chestnut	roasted walnut	black ST
Finish foil	alpine white	bleached craft oak	riviera oak	rustic oak							

## STANDARD OPTIONS

- » door leaf frame made of MDF
- » core made of „honeycomb“
- » transparent glass, thickness 4 mm

## OPTIONS WITHOUT EXTRA CHARGE

- » ventilation sleeves
- » three hinges - applies to rebated door leaf

## REBATED DOOR LEAF

- » straight edge
- » edge with radius R 2.5 mm made by directforming **available in CPL 2nd group Fig. 1 (rounded glass pane frame in CPL laminates)**
- » straight edge **fig. 2 (Slim glass pane frame in Finish foils)**
- » 2 silver screw-in pivot hinges
- » single-point mortise simple key lock, bathroom lock, cylinder lock or economic lock
- » **Realization of orders in the investment standard after consultation with the Contracts Department. The investment standard is a door frame passage with a leaf open at an angle of 90° for interior doors: "80" 800 mm, "90" 900 mm.**

## OPTIONS AVAILABLE WITH EXTRA CHARGE

- » Silent package 37dB (dropping seal + acoustic insert) - STANDARD INVEST 10
- » glass pane MAT DRE (applies to door leaf) STANDARD INVEST 20, 70, 80, BULAJ MDF
- » STANDARD INVEST 60
- » stabilising insert tubular chipboard
- » "100" door leaves
- » ventilation undercut
- » recuperative undercutting -15mm
- » plastic ventilation grille
- » aluminum ventilation grille
- » there is possibility to purchase metal BULAJ separately in black or steel colour

\* Note: Selected configurations of rebated alpine white STANDARD INVEST 10 model are available from stock.

fig. 1



fig. 2

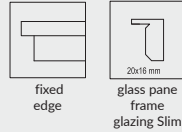

STANDARD INVEST 10

STANDARD INVEST 20

STANDARD INVEST 60

STANDARD INVEST 70

STANDARD INVEST 80

BULAJ INVEST MDF

steel BULAJ INVEST



black steel Bulaj \*



steel Bulaj \*

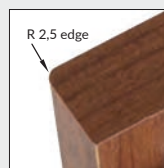

R 2,5 mm edge

\* only MATT or transparent glass pane available

## STANDARD OPTIONS

- » edge radius R 2.5 mm only for laminates 0.15-0.20 mm from CPL 2nd group
- » straight edge for laminates 0.15-0.20 mm and 0.7 mm
- » door leaf frame made of softwood
- » core made of „honeycomb“
- » glass pane white bark 4 mm thick
- » CPL laminate 0.15 - 0.2mm or 0.7mm

## OPTIONS WITHOUT EXTRA CHARGE

- » glass pane „chinchila“ or „window blind“
- » ventilation sleeves
- » three hinges - applies to rebated door leaf

## REBATED DOOR LEAF

- » straight edge
- » edge with radius R 2.5 mm made by directforming available in 2nd group of CPL 0.15-0.20 mm laminates **Fig. 1**
- » straight edge for laminates 0.7 mm **fig.1**
- » 2 silver screw-in pivot hinges
- » single-point mortise simple key lock, bathroom lock, cylinder lock or economic lock
- » **Realization of orders in the investment standard after consultation with the Contracts Department. The investment standard is a door frame passage with a leaf open at an angle of 90° for doors: interior doors "80" 800 mm, "90" 900 mm.**

## NON-REBATED DOOR LEAF (EXTRA CHARGE)

- » edge without rebate, rounded glass pane frame **fig. 2**
- » sockets for 2 recessed Estetic 80 hinges (hinges constitute a part of the door frame)
- » magnetic simple key lock, bathroom lock, cylinder lock or economic lock

## SLIDING DOOR LEAF

- » edge without rebate, rounded glass pane frame **fig. 2**
- » socket for hook lock and/or for handles

**NOTE: colours equivalent: W0118 - WHITE**

**NOTE: the Silent package applies to rebated and non-rebated single leaf door.**

## OPTIONS AVAILABLE WITH EXTRA CHARGE

- » Silent package 37dB (dropping seal + acoustic insert) - STANDARD 10 CPL
- » glass pane MAT DRE, DECORMAT BROWN, DECORMAT GRAPHITE (applies to door leaf) STANDARD 20, BULAJ MDF STANDARD 60
- » white frost VSG 22.1 safe, complex glass pane STANDARD 20 STANDARD 60
- » MDF BULAJ
- » stabilising insert tubular chipboard
- » "100" door leaves
- » door leaf "110" (only STANDARD 10) laminates 0.15 - 0.20 mm
- » non-rebated door leaf
- » Additional upper single point mortise lock (available only in STANDARD 10 door leaf model with core made of tubular chipboard and fixed door frame)
- » plastic ventilation grille
- » aluminum ventilation grille
- » cover strip for non-rebated double leaf door
- » ventilation undercut
- » recuperative undercutting -15mm
- » double leaf door leaf price x2
- » there is possibility to purchase steel BULAJ separately in black or steel colour
- » **NOTE: third Estetic 80 hinge for non-rebated doors (extra charge is added to the price of the door frame)**

**0.7 mm CPL laminate is also available in the "110" door leaf width and in Standard CPL 20, 60 models, BULAJ MDF, steel BULAJ - to place an order, please contact the Customer Service Department.**

fig. 1



fixed edge



25x19 mm  
glass pane frame rounded

fig. 2



edge R 2,5

fig. 2



edge without rebate



25x19 mm  
glass pane frame rounded



STANDARD 10

STANDARD 20

STANDARD 60

BULAJ MDF

steel BULAJ



steel or black steel BULAJ (available only MAT or transparent glass pane)



R 2,5 mm edge

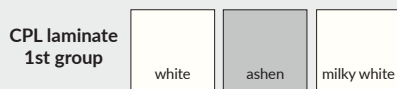



## STANDARD OPTIONS

- » door leaf frame made of softwood
- » core made of „honeycomb”

## OPTIONS WITHOUT EXTRA CHARGE

- » ventilation sleeves

## REBATED DOOR LEAF

- » straight edge with the edging band
- » edge with radius R 2.5 mm made by directforming **available in CPL 2nd group Fig. 1**
- » 3 silver screw-in pivot hinges
- » single-point mortise simple key lock, bathroom lock, cylinder lock or economic lock

## NON-REBATED DOOR LEAF (EXTRA CHARGE)

- » edge without rebate **fig. 2**
- » sockets for 2 recessed Estetic 80 hinges (hinges constitute a part of the door frame)
- » magnetic simple key lock, bathroom lock, cylinder lock or economic lock

## OPTIONS AVAILABLE WITH EXTRA CHARGE

- » Silent 37dB package (1983) (dropping seal + acoustic filling) - STANDARD 10
- » Silent 37dB package (2110 and 2240) (dropping seal + acoustic filling) - STANDARD 10
- » core made of: perforated chipboard (1983) tubular chipboard (2110 and 2240)
- » door leaf "90" - "100" (1983) DRE - CELL
- » door leaf "90" - "100" (2110 and 2240) DRE - CELL
- » door leaf "90" - "100" (1983) DRE - CELL
- » door leaf "100" (2110 and 2240) DRE - CPL
- » non-rebated door leaf
- » ventilation undercut
- » plastic ventilation grille
- » aluminum ventilation grille
- » cover strip for non-rebated double leaf door
- » double leaf door leaf price x2
- » **NOTE:** third Estetic 80 hinge for non-rebated doors (extra charge is added to the price of the door frame)

There is available 0,7 mm CPL laminate- to place an order and for more information please contact Customer Service Department.

Door leaf, dependent on selected height option - 1983 mm, 2110 mm or 2240 mm is dedicated to door frames with three hinges in corresponding heights.

**NOTE:** colours equivalent: W0118 - WHITE

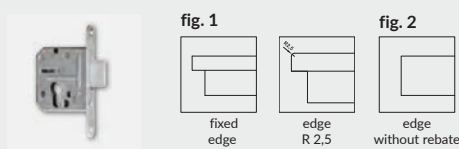

additional upper single point mortise lock (available only in STANDARD 10 door leaf model with core made of perforated chipboard and fixed door frame)

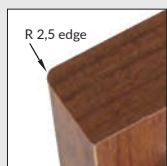

R 2,5 mm edge in CPL laminate

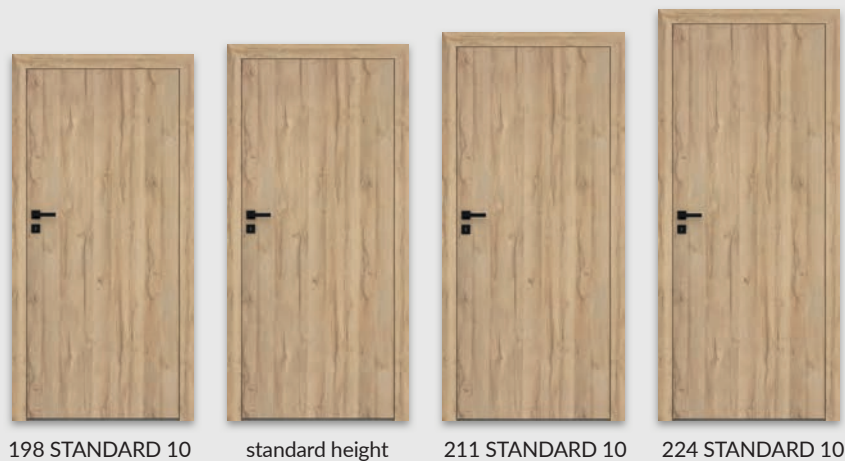

\*\*\* decor available only in horizontal graining  
\*while stock last

white matt	white (textured)	white pine	siberian elm	silver	sand oak	bleached oak textured	vintage oak	caramel walnut	DRE-Cell Decor		
golden oak textured	walnut	anthracite elm	dark wenge	toffee elm***	marrone chestnut textured	light gray matt	evoke oak				
							milky white	white	ashen	CPL laminate 1st group	
black ST	gray dark	concrete 2	gray oak	welsh oak	acacia	celini walnut	walnut	honey oak	chestnut	roasted walnut	CPL Laminate 2nd group

# MODERN

REBATED AND NON-REBATED DOOR LEAF WITH DIFFERENT HEIGHT  
interior door leaves



## STANDARD OPTIONS

- » door leaf frame made of softwood
- » core made of „honeycomb”
- » glass pane white bark 4 mm thick

## OPTIONS WITHOUT EXTRA CHARGE

- » glass pane „chinchila” or „window blind”
- » ventilation sleeves

## REBATED DOOR LEAF

- » straight edge, flat glass pane frame (in CPL laminate - rounded glass frame pane) flat 4 mm HDF panels **fig. 1**
- » 3 silver screw-in pivot hinges
- » single-point mortise simple key lock, bathroom lock, cylinder lock or economic lock

## NON-REBATED DOOR LEAF (EXTRA CHARGE)

- » edge without rebate, flat glass pane frame ( in CPL - rounded glass pane frame), flat 4 mm HDF panels **fig. 2**
- » sockets for 2 recessed Estetic 80 hinges (hinges constitute a part of the door frame)
- » magnetic simple key lock, bathroom lock, cylinder lock or economic lock

**NOTE:** In rebated door leaves with CPL laminates there is possibility to choose a door leaf with an edge radius R=2.5 mm, except for white, milky white and gray laminates.

**NOTE:** Different heights are available in all models of MODERN collection.

Door leaf, dependent on selected height option - 1983 mm, 2110 mm or 2240 mm is dedicated to door frames with three hinges in corresponding heights.

## OPTIONS AVAILABLE WITH EXTRA CHARGE

- » glass pane MAT DRE, DECORMAT BROWN, DECORMAT GRAPHITE (applies to door leaf) MODERN 20  
MODERN 30  
MODERN 40  
MODERN 50
- » white frost VSG 22.1 safe, complex glass pane p. 77
- » core made of: perforated chipboard (1983 and 2043)  
tubular chipboard (2110 and 2240)
- » door leaf „90” and „100” (1983 and 2043)
- » door leaf "90" and "100" (2110 and 2240)
- » non-rebated door leaf
- » ventilation undercut
- » plastic ventilation grille
- » aluminum ventilation grille
- » cover strip for non-rebated double leaf door
- » double leaf door leaf price x2
- » **NOTE:** third Estetic 80 hinge for non-rebated doors (extra charge is added to the price of the door frame)

**NOTE:** collection MODERN 10-50 coated with CPL laminate in standard height is available in sliding version.

fig. 1



fixed edge



21x16 mm

bar glazing flat



25x19 mm  
glass pane frame rounded glass pane frame (CPL)



flat panel

fig. 2



edge without rebate



21x16 mm

bar glazing flat



25x19 mm

glass pane frame rounded glass pane frame (CPL)



flat panel



198 MODERN 30

standard height

211 MODERN 30

224 MODERN 30

DRE-Cell Decor



\* decor available while supplies last

\*\*\* decor available only in horizontal wood grain

CPL laminate 1st group

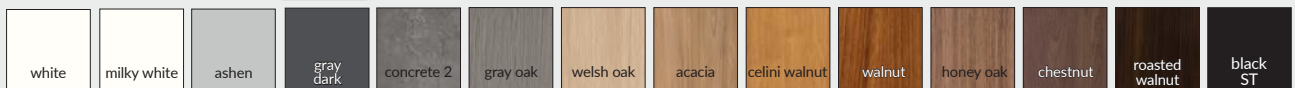

### STANDARD OPTIONS

- » door leaf frame made of softwood
- » core made of „honeycomb“
- » glass pane white bark 4 mm thick

### OPTIONS WITHOUT EXTRA CHARGE

- » glass pane „chinchila“ or „window blind“
- » ventilation sleeves

### REBATED DOOR LEAF

- » straight edge, flat glass pane frame (in CPL laminate - rounded glass frame pane) flat 4 mm HDF panels **fig. 1**
- » 3 silver screw-in pivot hinges
- » single-point mortise simple key lock, bathroom lock, cylinder lock or economic lock

### NON-REBATED DOOR LEAF (EXTRA CHARGE)

- » edge without rebate, flat glass pane frame (in CPL laminate - rounded glass pane frame), flat 4mm HDF panels **fig. 2**
- » sockets for 2 recessed Estetic 80 hinges (hinges constitute a part of the door frame)
- » magnetic simple key lock, bathroom lock, cylinder lock or economic lock

**NOTE:** In rebated door leaves with CPL laminates there is possibility to choose a door leaf with an edge radius R=2.5 mm, except for white, milky white and gray laminates.

**NOTE:** Different heights are available in all models of PLUS collection.

Door leaf, dependent on selected height option - 1983 mm, 2110 mm or 2240 mm is dedicated to door frames with three hinges in corresponding heights.

### OPTIONS AVAILABLE WITH EXTRA CHARGE

- » glass pane MAT DRE, DECORMAT BROWN, DECORMAT GRAPHITE (applies to door leaf) PLUS 20 PLUS 40, 50, 60, 70, 80 PLUS 30
- » white frost VSG 22.1 safe, complex glass pane p. 81
- » core made of: perforated chipboard (1983 and 2043) tubular chipboard (2110 and 2240)
- » door leaf „90“ and „100“ (1983 and 2043)
- » door leaf "90" and "100" (2110 and 2240)
- » non-rebated door leaf
- » ventilation undercut
- » plastic ventilation grille
- » aluminum ventilation grille
- » cover strip for non-rebated double leaf door
- » double leaf door leaf price x2
- » **NOTE:** third Estetic 80 hinge for non-rebated doors (extra charge is added to the price of the door frame)

**NOTE:** collection PLUS 10-80 coated with CPL laminate in standard height is available in sliding version.

fig. 1

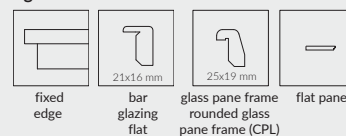
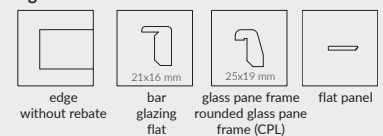

fig. 2



198 PLUS 30

standard height

211 PLUS 30

224 PLUS 30

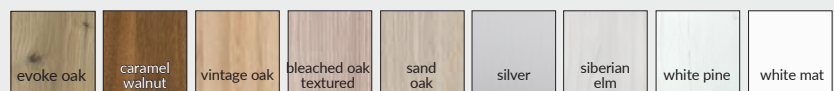

DRE-Cell Decor

\* decor available while supplies last  
\*\*\* decor available only in horizontal wood grain

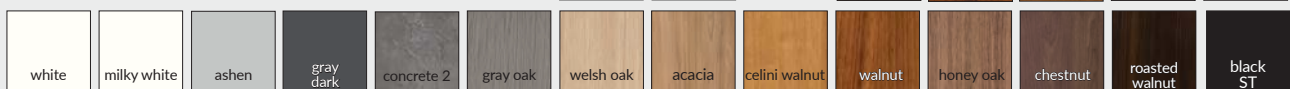

CPL Laminate 1st group



## ENA - white matt

The DRE wall-mounted sliding system is designed for single-leaf or double-leaf interior doors, in the sliding variant. It can be used for doors in our offer, with the following finishes: DRE-Cell, 3D foil, CPL laminates, as well as painted doors, except for the collections: Enter, Enter Akustik, Solid, Solid RC2, Forca B, fire resistant doors, glass doors and doors with variable heights.

In our sale offer there are available two different types of sliding system:

**NS** - system mounted directly on the wall

**NT** - sliding system mounted together with adjustable tunnel

There are two options of NT sliding system:

- » mounted together with adjustable tunnel with 63 mm architrave
- » mounted together with adjustable tunnel with 80 mm architrave

Set of sliding system comprises of: sliding guide bar with hardware (LEON SN 150, 180, 200), spacing board, masking strip, and fender beam (fender beam is available for single leaf - for doors with hook lock option in fender beam there is milling for latch).

The NT system is additionally supplemented with two 16 mm thick spacer strips with cross-sections adapted to the width of the architraves of 63 mm or 80 mm. The NS and NT systems also differ in the cross-section of the masking strip.

To complete entire set of sliding doors it is necessary to purchase sliding leaf unit in following dimensions:

Single leaf door: „60“, „70“, „80“, „90“, „100“

Double leaf door: „2x60“, „2x70“, „2x80“, „2x90“, „2x100“

Door leaf might be equipped with sockets for lock and/or handle - those accessories must be purchased separately.

In the system mounted with adjustable tunnel NT, it is necessary to purchase adjustable tunnel separately.

CPL 2nd group laminate applies to the natural halifax oak laminate with horizontal graining.



## ACCESSORIES

- » round handle 1 pcs.
- » oval handle 1 pcs.
- » Hook lock with the key with two round or oval handles
- » hook lock with toilet option with two round or oval handles
- » hook lock with cylinder lock insert with two round handles
- » One set of door handle for single leaf door consist of 2 pcs.



hook lock with a key and a handle round  
hook lock with key and handle oval

## masking strip with guide bar

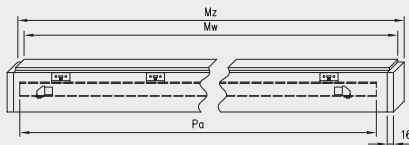

Masking strip and guide bar for double sliding system is made by connecting two elements of single system.

## Single sliding system

Dimension door [mm]	Masking strip		Guide bar
	Mz	Mw	Pa
644, 744	1620	1588	1500
844	1920	1888	1800
944	2120	2088	2000
1044	2160	2128	2000

## double leaf door sliding system

Dimension door [mm]	Masking strip		Guide bar
	Mz	Mw	Pa
2 x 644	2 x 1519	2 x 1503	2 x 1500
2 x 744	2 x 1519	2 x 1503	2 x 1500
2 x 844	2 x 1819	2 x 1803	2 x 1800
2 x 944	2 x 2019	2 x 2003	2 x 2000
2 x 1044	2 x 2063	2 x 2047	2 x 2000

## Single sliding system

symbol	"60"	"70"	"80"	"90"	"100"
A	602	702	802	902	1002
C	646	746	846	946	1046
D	664	764	864	964	1064
E	752	852	952	1052	1152
E*	786	886	986	1086	1186
S	644	744	844	944	1044

## double leaf door sliding system

symbol	"120"	"140"	"160"	"180"	"200"
A	1200	1400	1600	1800	2000
C	1244	1444	1644	1844	2044
D	1264	1464	1664	1864	2064
E	1350	1550	1750	1950	2150
E*	1384	1584	1784	1984	2184
S**	644	744	844	944	1044

E\* refers to a tunnel with an architrave. T80  
S\*\* width of single leaf door

## NT - vertical cross-section on a tunnel with an architrave 63 mm

## NT - vertical cross-section on a tunnel with an architrave 80 mm

## NS - vertical cross-section

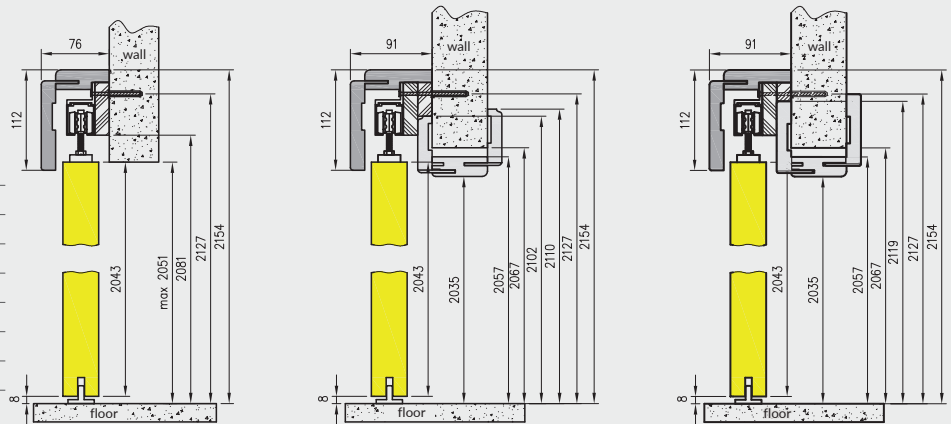

Height of sliding door leaf unit - 2043 mm  
total height of sliding system - 2154 mm

## NS - horizontal cross-section (left system)

## NT - horizontal cross-section (left system)

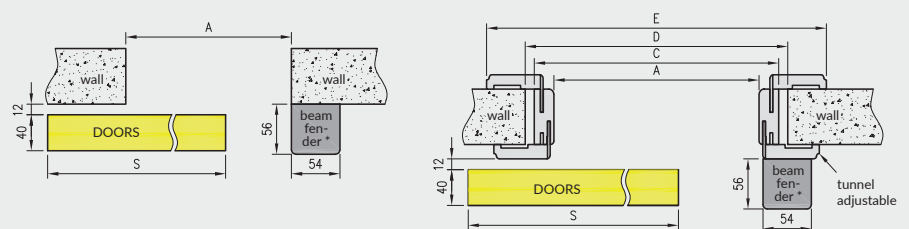

\* is not available in double leaf system

NOTE: In double sliding system masking strip is connected on length, by two single elements.

The "Spazio" sliding system for glass doors - made of anodized aluminum, is a complete solution designed for ready-made door frames. The set includes a running rail with a straight or oval blind, as well as elements for hanging the sliding glass pane and a bottom door guide. There are two options of Spazio System (only difference is in the shape of external blende):

- » Spazio TP - with straight blende
- » Spazio TO - with oval blende

## PRICE

» price of sliding system for a glass doors

To complete the whole system it is recommended to buy glass door leaf in sliding version from Galla collection. There is designed for this solution round handle.

## OPTIONS AVAILABLE WITH EXTRA CHARGE

» door handle (two-sided)



door handle  
(stainless steel)

Note: There is no possibility to make ventilation option.

Prices of GALLA glass door leaves on page 133

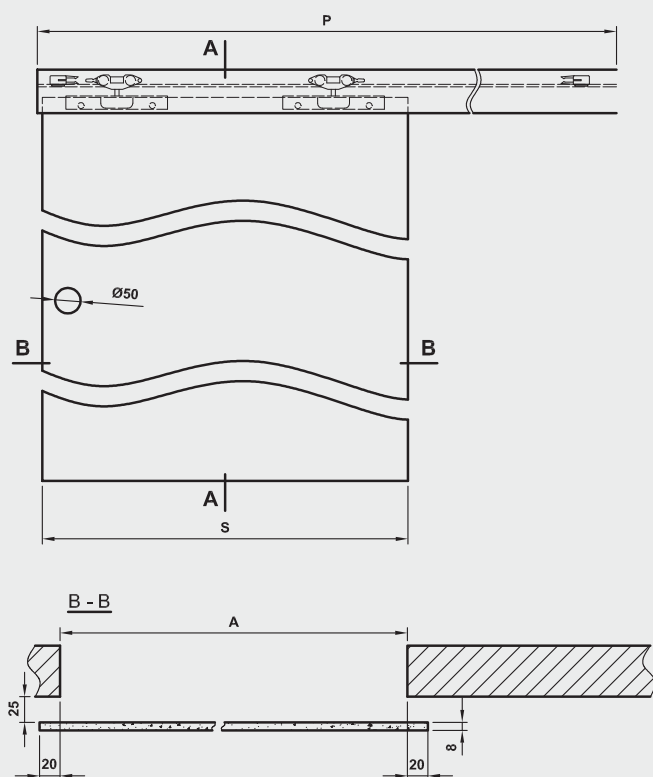
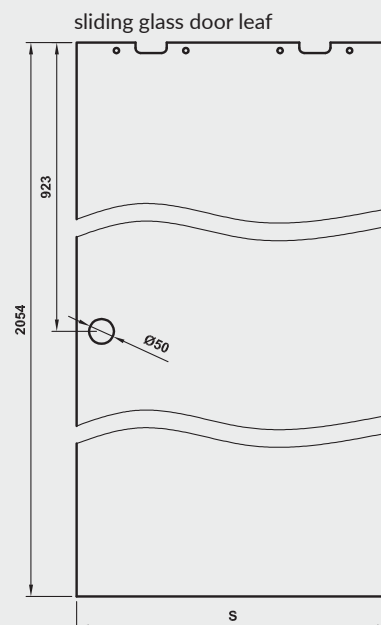

A - A vertical cross-section of Spazio TP

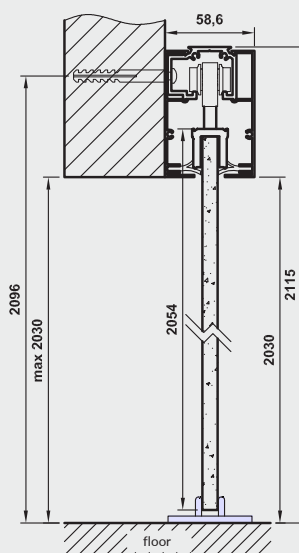

A - A vertical cross-section of Spazio TO

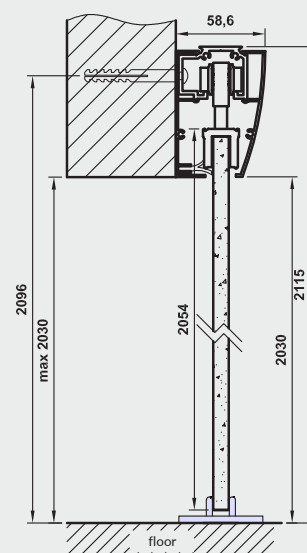

Tab. Dimensions

	S	A	P
"60"	630	590	1340
"70"	730	690	1540
"80"	830	790	1740
"90"	930	890	1940

S - width of door leaf unit  
A - width of wall passage  
P - length of guide channel

# SLIDING SYSTEM SPAZIO CD MOUNTED ON-WALL

SLIDING SYSTEM DOOR LEAF  
interior door leaves



## SPAZIO CD

Wall-mounted sliding system with an anodized guide and rectangular blende. Designed for panel and frame construction doors. This solution is intended for finished door frames.

To complete the system, you must purchase a sliding door from our offer in a version with a handle. The holder must be purchased separately (information on page 101).

## WHOLE SET COMPRISES OF:

- » guide channel with side caps
- » system sliding trolleys
- » door leaf hangers
- » bottom stopper
- » assembly kit (screws and bolts)

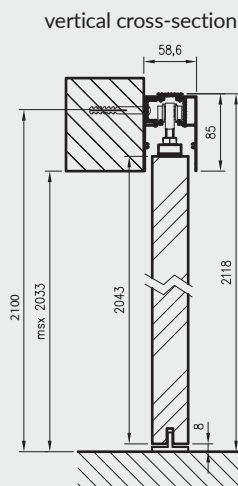
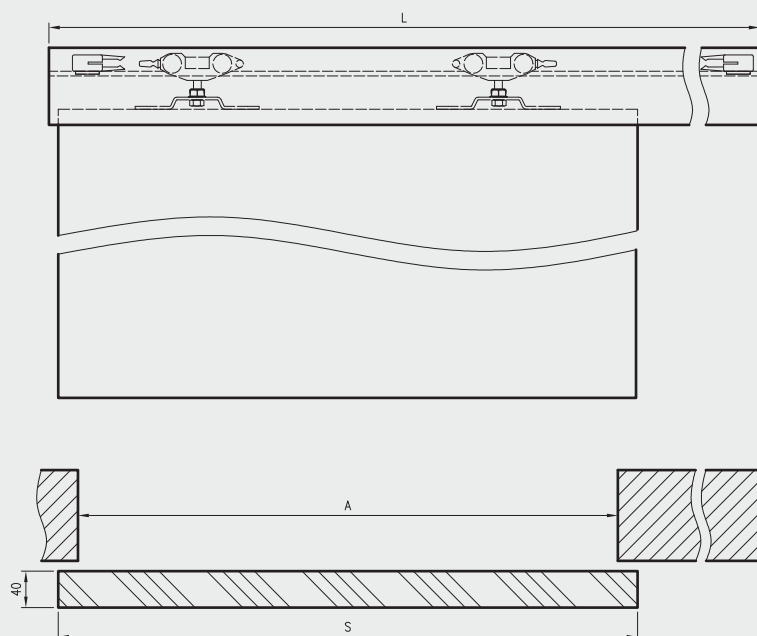

A - width of wall passage  
S - width of door leaf unit  
L - length of guide channel

	A	S	L
"60"	600	644	1370
"70"	700	744	1570
"80"	800	844	1770
"90"	900	944	1970
"100"	1000	1044	2170



Sliding system doors hidden in the wall (pocket system) PA - STANDARD 10 vintage oak

DRE-Cell Decor

white (textured)	white matt	white pine	siberian elm	silver	evoked oak	vintage oak	sand oak	bleached oak textured	walnut
caramel walnut	golden oak textured	toffee oak***	marrone chestnut textured	anthracite elm	wenge dark	antique copper	oxide concrete	black matt 2	
light gray matt	dark olive matt	dark blue matt	cashmere matt	warm gray matt	sage oak				

3D Decor

grand oak	elm	walnut american	ebony*	Polish oak 3D
-----------	-----	-----------------	--------	---------------

\*\*\* decor available only in horizontal wood grain

\*while stock last

Painted decor

white	ecru	latte	ashen
-------	------	-------	-------

white acrylic UV varnish - RAL 9003  
 ecru - RAL 9001  
 latte - Flugger 4362, NCS S1505-Y50R  
 ashen - RAL 7035



# SLIDING SYSTEM DOORS HIDDEN IN THE WALL (POCKET SYSTEM)

SLIDING SYSTEM DOOR LEAF  
interior door leaves

## PA DOOR FRAME CASSETTE

System assembly involves embedding the cassette in the construction of profiles used to build a plasterboard wall (or other construction) with a thickness of:

- » 100 mm for the PA 100 mm door frame cassette
- » 125 mm for the PA 125 mm door frame cassette

Next, wide surfaces construction with the usage of 12.5mm plasterboards (plasterboards must be purchased separately) and finishing these surfaces and assembly of Tunnel Cassette Cover.

**NOTE:** VETRO A, VETRO D and VETRO B door leaf with a width of "70" do not fit the 100 mm and 125 mm PA cassettes.

**In addition, the 100 mm PA cassettes cannot be used with door leaves with locks and panel construction doors with glazing or panels**

### THE SET INCLUDES:

- » cassette elements made of aluminum elements and accessories for its assembly
- » elements that allow for decorative built-up jambs - so called Tunnel Cassette Cover with the architraves 80mm width

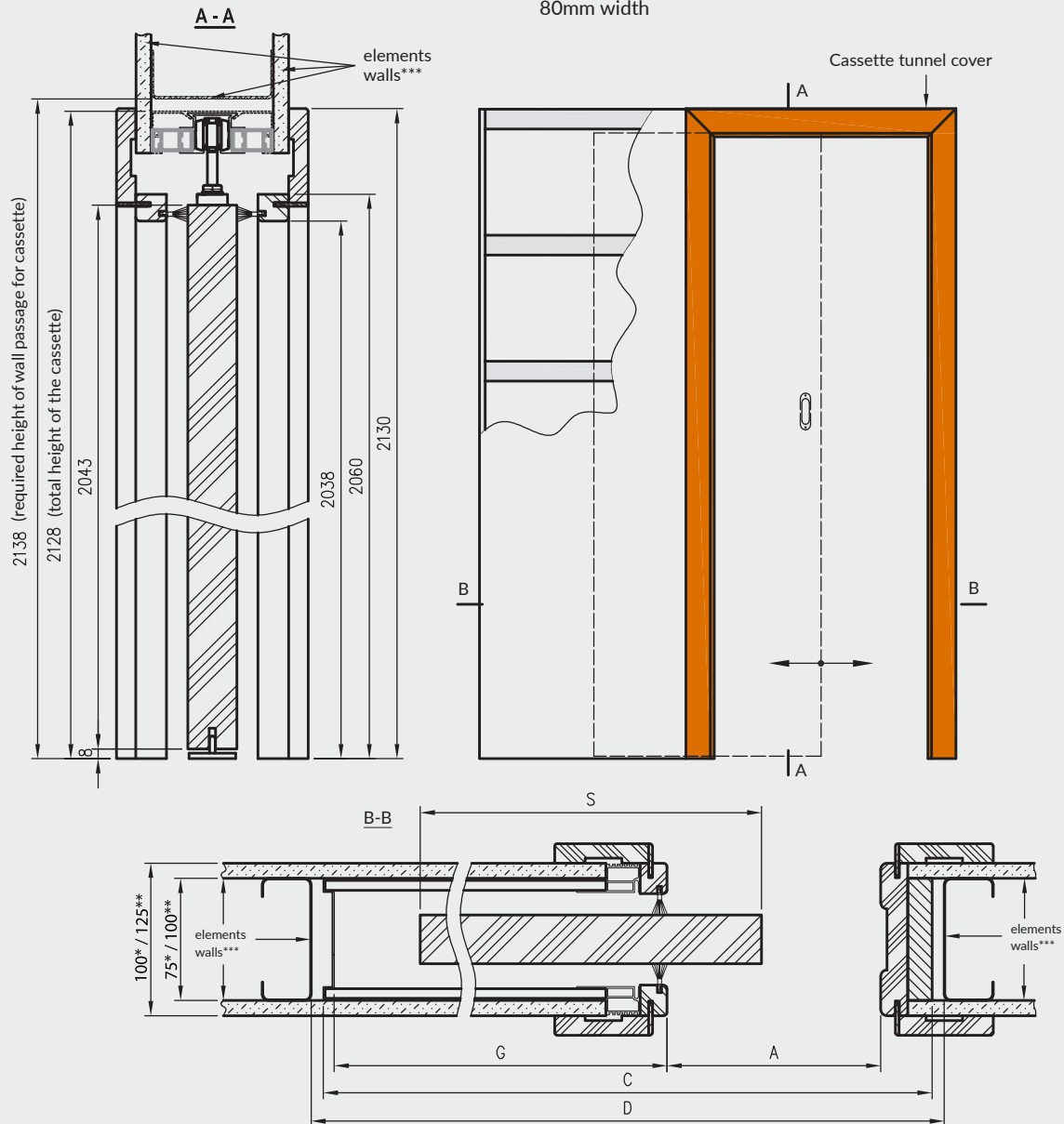

Width	A	S	C	D	G
60	600	644	1310	1330	656
70	700	744	1510	1530	756
80	800	844	1710	1730	856
90	900	944	1910	1930	956
100	1000	1044	2110	2130	1056

\* dimensions refer to the 100mm PA cassette  
 \*\* dimensions refer to 125mm PA cassette  
 \*\*\* wall elements are not components of the product

C - total width of cassette  
 D - width of walls passage prepared for cassette  
 G - depth of ready cassette

# DOOR FRAMELESS CASSETTE B01

SLIDING SYSTEM DOOR LEAF  
interior door leaves

## DOOR FRAMELESS CASSETTE B01

Door frameless cassette with the possibility of assembly and disassembly of the door leaf after cassette assembly and finishing. System assembly involves embedding the cassette in the construction of profiles used to build a plasterboard wall (or other construction) with a thickness of:

- » 100 mm for the B01 100 mm door frameless cassette
- » 125 mm for the B01 125 mm door frameless cassette

Then covering wide surfaces with 12.5 mm plasterboards (plasterboards must be purchased separately) and finishing these surfaces.

### LIST OF DOOR COLLECTIONS AND MODELS AVAILABLE IN THE DOOR FRAMELESS CASSETTE SYSTEM B01:

ESTRA; VERANO; ENA; TRIESTA; SOLTE; REVA; FOSCA; NESTOR; AURI; ELSA; PREMIUM; PIANO; SCALA; VERSO; BERGE; EVEN; NOVA 10; RIVIA 10, RIVIA 60-130; GALERIA ALU 10, 20, 30, 50, 60; FINEA 10, 40; STANDARD 10, UNI 10; FARGO 10-60; BINITO 10-90  
The door leaves have additional milling on the upper edge. Doors with locks and panel constructions doors with glazing and panels cannot be used with B01 door frameless cassettes.

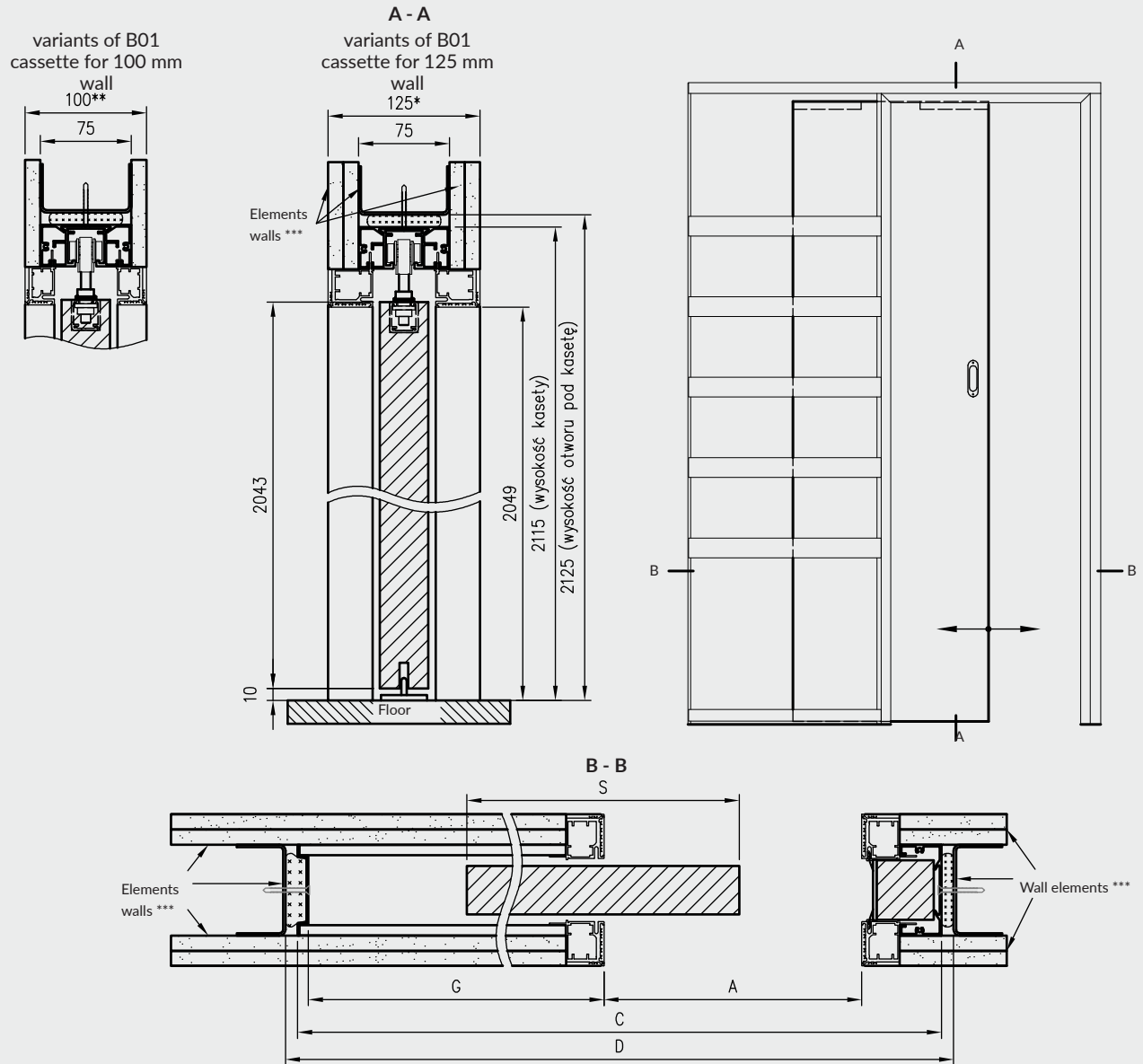

Width	S	A	C	D	G
60	644	626	1360	1380	659
70	744	726	1560	1580	759
80	844	826	1760	1780	859
90	944	926	1960	1980	959
100	1044	1026	2160	2180	1059

\* variant of B01 cassette for 125 mm wall

\*\* variant of B01 cassette for 100 mm wall

\*\*\* wall elements are not components of the product

S - door leaf width

A - width of the door frame passage

C - total width of cassette

D - width of walls passage prepared for cassette

G - depth of ready cassette



**NON-REBATED - OPENED OUTWARDS AND INVERTED REBATE - OPENED INWARDS**

The PROFI system door with an aluminum door frame and a 50 mm thick door leaf is an innovative solution that allows for creative interior design with the usage of invisible doors, with the option of finishing the door leaf surface in the same colors as the walls.

**PROFI DOOR STRUCTURE INCLUDES:**

Aluminum door frame, invisible after installation, built into the reveal or covered with plasterboards. After masonry processing, only the frame notch is visible, ready for painting, e.g. in the color of the walls.

Non-rebated panel construction door leaf and inverted rebate in two finishing options:

- » Wide door leaf surfaces primed and ready for painting or wallpapering (e.g. in the color of the walls). The edges of the door leaf are covered with a edging that can be painted. Painting should be done on your own or you can choose a painted decor.
- » Wide surfaces of the door leaf and edges painted with white acrylic UV varnish.

**OPTIONS AVAILABLE WITH EXTRA CHARGE**

- » ventilation undercut
- » dropping seal
- » Silent package 37dB (dropping seal + acoustic insert) - Standard 2043
- » Silent package 37dB (dropping seal + acoustic insert) - Standard 2240

Non-rebated door frame profile



Inverted door frame profile rebates

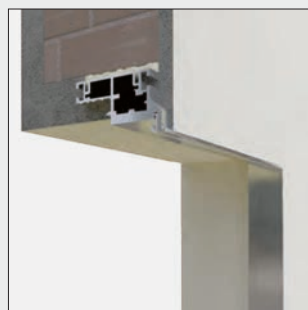

Door leaf decors:



Decor

Painted decor

white acrylic UV varnish - RAL 9003

Extra charge for the third Estetic 80 hinge

## NON-REBATED - OPENED OUTWARDS IN THE 2043, 2240 STANDARD NORMS

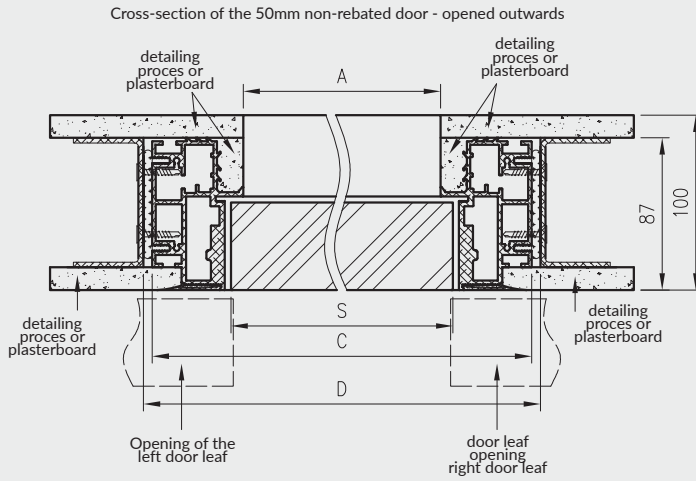

Vertical section of 50mm non-rebated door opened outwards

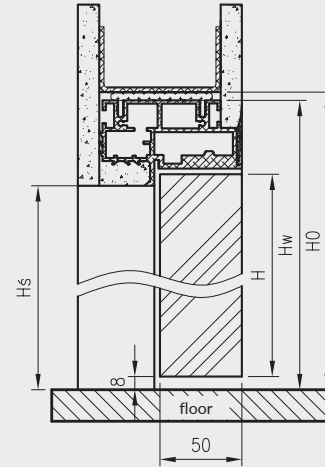

Profi door width dimensions

	S	A	C	D
"60"	600	586	690	700
"70"	700	686	790	800
"80"	800	786	890	900
"90"	900	886	990	1000
"100"	1000	986	1090	1100

Dimensions of non-rebated door leaves

standard	H	H <sup>S</sup>	hw	H <sub>0</sub>
2043	2043	2044	2096	2101
2240	2240	2241	2293	2298

## INVERTED REBATE - OPENED INWARDS IN THE 2043, 2240 STANDARD NORMS

Cross-section of 50mm inverted rebate door - opened inwards

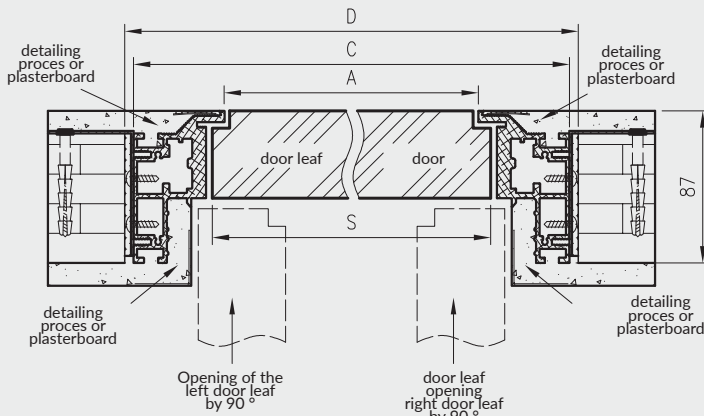

Vertical section of 50mm inverted rebate door - opened inwards

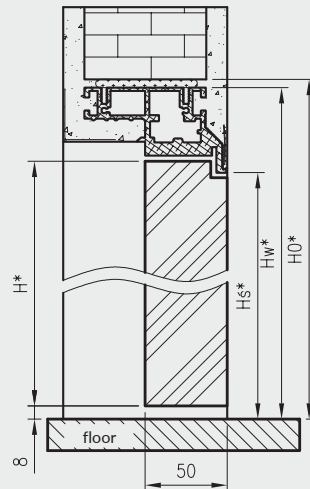

Profi door width dimensions

	S	A	C	D
"60"	600	586	690	700
"70"	700	686	790	800
"80"	800	786	890	900
"90"	900	886	990	1000
"100"	1000	986	1090	1100

height dimensions of rebated doors

standard	H	H <sup>S</sup>	hw	H <sub>0</sub>
2043	2053	2054	2106	2111
2240	2250	2251	2303	2308

S - door leaf width  
A - width of passage in door frame unit  
C - external width of door frame  
D - required width of wall opening  
H<sub>0</sub> - height of the wall opening



### Door leaf decors

cashmere matt	warm gray matt	sage oak	dark olive matt	dark blue matt	white (textured)	white matt	white pine	siberian elm	light gray matt	silver	DRE-Cell Decor 1st group	
<b>NEW</b>												
						sand oak	bleached oak textured	vintage oak	caramel walnut	golden oak textured	marrone chestnut textured	DRE-Cell Decor 2nd group
						evoked oak	toffee oak***	walnut	anthracite elm	dark wenge		
									antique copper	oxide concrete		
												3D Decor
						grand oak	elm	walnut american	ebony**	Polish oak 3D		
												Painted decor
						white	ecru	latte	ashen			
												CPL Laminate
										black ST		
												Decor
										primed		

\* decor with a door leaf edge in black colour  
 \*\*while stock last  
 \*\*\* decor available only in horizontal wood grain

### Available colours of aluminum door frames



aluminum

White RAL 9003

black

## NON-REBATED - OPENED OUTWARDS AND INVERTED REBATE - OPENED INWARDS

Sara Eco 2 door leaf is an innovative solution for creative interior design with the use of "invisible" doors. This unique construction gives possibility to finish surface of door leaf in the colors of the walls.

### CONSTRUCTION OF SARA ECO 2 DOOR LEAF COMPRISES OF:

Aluminum door frame, invisible after installation, built into the reveal or covered with plasterboards. After masonry processing, only the frame notch is visible, ready for painting, e.g. in the color of the walls.

Non-rebated panel construction door leaf and inverted rebate in two finishing options:

- » Wide door leaf surfaces primed and ready for painting or wallpapering (e.g. in the color of the walls). The edges of the door leaf are covered with a edging that can be painted. Painting should be done on your own or you can choose painted decors.
- » Wide door leaf surfaces covered with foils from DRE-Cell, 3D, CP black ST groups or with painting foil in the group of painted decors, the edges of the door leaf covered with the edging in the color of the foil (except for antique copper and concrete oxide colors).

### OPTIONS AVAILABLE WITH EXTRA CHARGE WITH PRIMER

- » ventilation undercut
- » recuperative undercutting -15mm
- » tubular chipboard in standard 202
- » tubular chipboard in 220 standard
- » tubular chipboard in standard 240

### STANDARD OPTION

- » door leaf frame made of softwood
- » sockets for 2 or 3 recessed hinges, new hinges with increased load capacity up to 60 kg are used in white and black door frame colors
- » core made of „honeycomb“
- » white or silver simple key magnetic lock, toilet lock, cylinder lock or economic lock

### OPTIONS AVAILABLE WITH EXTRA CHARGE IN DRE-CELL, 3D AND PAINTED

- » ventilation undercut
- » recuperative undercutting -15mm
- » plastic ventilation grille
- » aluminum ventilation grille
- » dropping seal
- » tubular chipboard in standard 202
- » tubular chipboard in 220 standard
- » tubular chipboard in standard 240

Price of the door frame includes 2 or 3 hidden concealed hinges.

Note: in option with stabilising insert as tubular chipboard, in standard 202 it is required to use 3 hinges.

## NON-REBATED - OUTWARD OPENING, DRE DOOR FRAME

Horizontal cross-section of the Sara Eco 2 non-rebated door - opening outwards

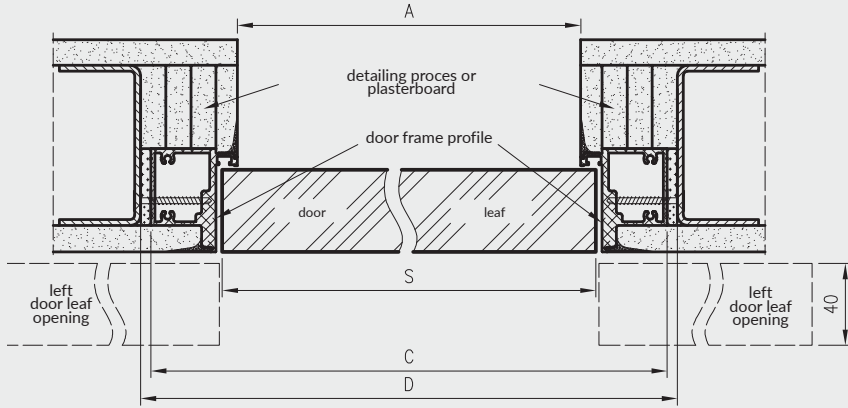

Vertical cross-section of the Sara Eco 2 non-rebated door leaves - opening outwards

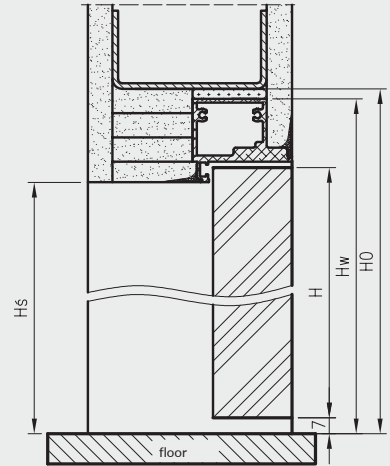

Dimensions of the door leaf width Sara

	S	A	C	D
"60"	620	605	690	700
"70"	720	705	790	800
"80"	820	805	890	900
"90"	920	905	990	1000
"100"	1020	1005	1090	1100

height dimensions of rebated doors

standard	H	Hs	hw	H0
202x	2020	2020	2062	2070
220X	2200	2200	2242	2250
240X	2400	2400	2442	2450

## INVERTED REBATE - INWARD OPENING, DRE DOOR FRAME

Cross-section of Sara Eco 2 with inverted rebate - opened inwards

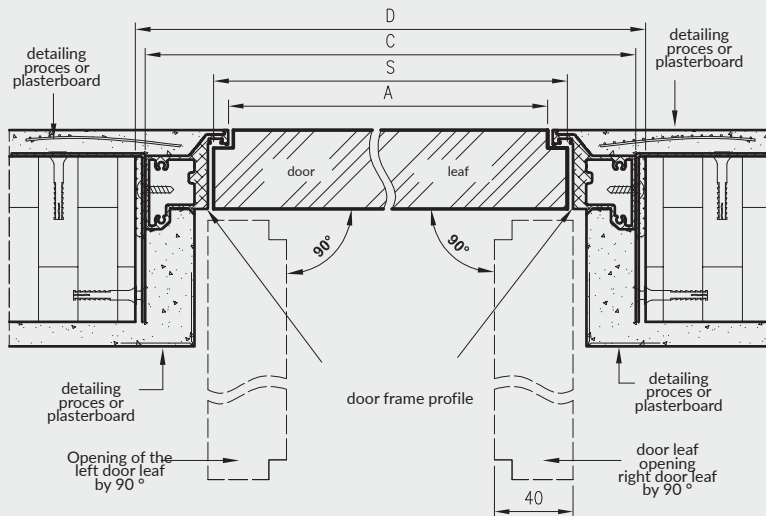

Vertical section of Sara Eco 2 with inverted rebate - opened inwards

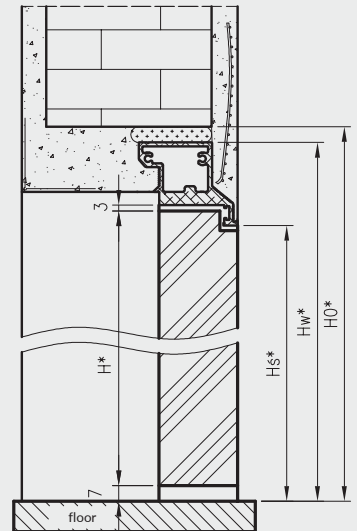

Dimensions of the door leaf width Sara Eco 2

	S	A	C	D
"60"	620	605	690	700
"70"	720	705	790	800
"80"	820	805	890	900
"90"	920	905	990	1000
"100"	1020	1005	1090	1100

height dimensions of rebated doors

standard	H*	Hs*	Hw*	H0*
202x	2030	2030	2072	2080
220X	2210	2210	2252	2260
240X	2410	2410	2452	2460

S - door leaf width  
A - width of passage in door frame unit  
C - external width of door frame  
D - required width of wall opening



folding doors FOLDE 10 - white matt

DRE-Cell Decor	white matt	white (textured)	white pine	siberian elm	silver	sand oak	bleached oak textured	vintage oak	caramel walnut
	golden oak textured	walnut	anthracite elm	dark wenge	toffee oak***, *	marrone chestnut textured	light gray matt	evoked oak	
3D Decor	grand oak	elm	walnut american	ebony*	Polish oak 3D				

\*\*\* decor available only in horizontal wood grain

\*while stock last



The folding door system is characterized by the fact that when opening the door, the leaves fold into a position parallel to each other. The folding door system includes:

- » two-elements door leaf connected by 3 hidden recessed hinges
- » adjustable door frame for folding doors

## STANDARD OPTIONS

- » door leaf frame made of softwood
- » core made of „honeycomb“
- » straight edge **fig. 1**
- » single-point mortise simple key lock, bathroom lock, cylinder lock or economic lock
- » 3 hidden recessed ISTAR hinges installed between two-elements of door leaf unit

## OPTIONS AVAILABLE WITH EXTRA CHARGE

- » core made of tubular chipboard
- » door leaf "90" and "100"

fig. 1

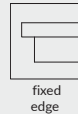

fixed edge

Cross-section of folding doors in closed position\*  
(right doors, left doors are mirror reflection)

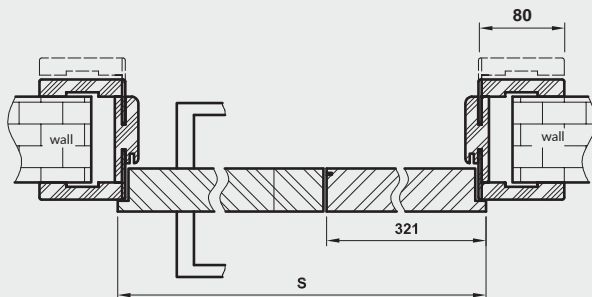

Cross-section of folding doors in opened position\*

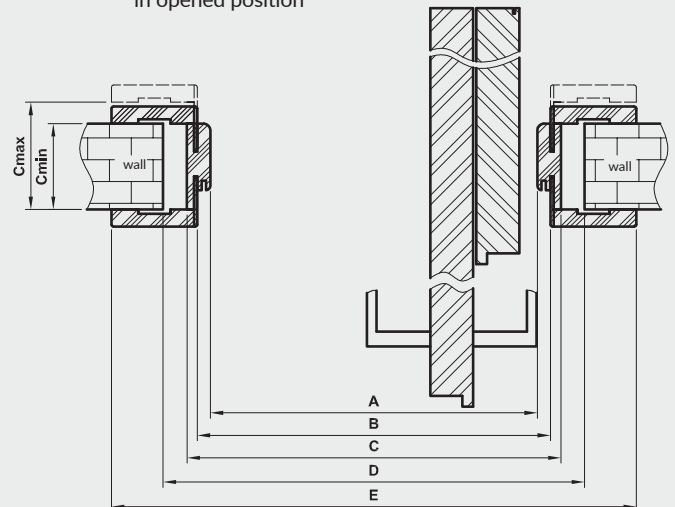

\*NOTE: When doors are fully opened, the door fittings slightly reduce the clear opening by approx. 10 cm. (this value doesn't take into account door handle)

Tab. Dimensions

	S	A	B	C	D	E
"80"	844	806	830	850	880	990
"90"	944	906	930	950	980	1090
"100"	1044	1006	1030	1050	1080	1190

D - required width of wall opening

NOTE: There is no possibility to shorten door leaf.

vertical cross-section

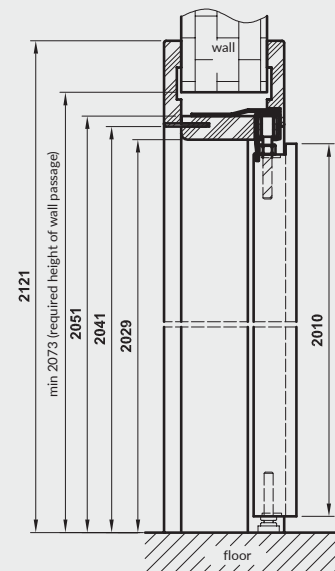

## STANDARD OPTIONS

- » door leaf frame made of softwood
- » core made of „honeycomb”
- » glass pane 4 mm thick: white bark, "window blind", CHINCHILA, MAT DRE, DECORMAT BROWN or DECORMAT GRAPHITE.
- » 2 silver screw-in pivot hinges
- » latch strike plate and two flush bolts
- » options: straight edge \*, flat glass pane frame or black Slim glass pane frame fig. 1

## OPTION WITHOUT EXTRA CHARGE

- » three hinges applies to rebated door leaf
- » black glass pane frame Slim

## OPTIONS AVAILABLE WITH EXTRA CHARGE

- » white frost VSG 22.1 safe, complex glass pane DOSTAWKA 30 EXTRA 40 ADDITIONAL BOX 41 core made of tubular chipboard 77, +30%
- » door frame for door leaf with side panel

Side panel it is passive rebated door leaf unit with "40" width and 40 mm thick, with glazing or without glazing option, in uniform wood grain. Side panels can be paired with interior rebated door leaf in the following combination: „60+40”; „70+40”; „80+40”; „90+40”; „100+40”.

Side extension 10 can be used for rebated interior doors. Side extension 30 is suitable for ARTE 10-30 models and STANDARD 30. Side extension 40 is suitable for ARTE 40, 50, 90 models; STANDARD 40, KANON 30, DECO collection. Side extension 41 is adapted to MODERN 30 and PLUS 30 models.

To make the best possible match of side panel to door leaf unit, besides selection of model, it is necessary to choose the correct colour, type of the edge and number of hinges.

**NOTE:** There is no possibility to shorten side panels.

fig. 1

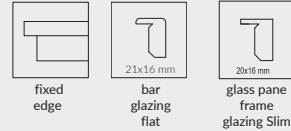

3D Decor	elm	walnut american	ebony*	Polish oak 3D	grand oak													
DRE Cell Decor	white matt	white (textured)	white pine	siberian elm	silver	oak sand	bleached oak textured	vintage oak	caramel walnut									
	golden oak textured	walnut	toffee elm***	marrone chestnut textured	evoke oak	light gray matt	anthracite elm	dark wenge										
CPL Laminate	white	milky white	ashen	gray dark	concrete 2	gray oak	welsh oak	acacia	celini walnut	walnut	honey oak	chestnut	roasted walnut	black ST				

\*\*\* decor available only in horizontal wood grain

\*while stock last

## STANDARD OPTIONS

- » stiles made of wood-based panels
- » glass pane 4 mm: MAT DRE, decormat brown, decormat graphite or transparent glass
- » 3 silver screw-in pivot hinges
- » latch strike plate and two flush bolts
- » straight edge **fig. 1**

fig. 1



## OPTIONS AVAILABLE WITH EXTRA CHARGE

- » door frame for door leaf with side panel +30%

**NOTE:** Price of side panel is equal to the price of corresponding door leaf model.

There is possibility to make side panels to all frame construction door leaf, available in presented collections, in following combinations: „60+40“; „70+40“; „80+40“; „90+40“; „100+40“

**NOTE:** There is no possibility to shorten side panels.



white (textured)	white matt	white pine	light gray matt	siberian elm	sand oak	bleached oak textured	marrone chestnut textured	DRE-Cell Decor
	golden oak textured	anthracite elm	evoke oak	black matt 2	dark wenge	caramel walnut	vintage oak	
			elm	walnut american	ebony*	Polish oak 3D	grand oak	3D Decor

\*while stock last

# TRANSOM LIGHTS / SIDELIGHTS



Possible configuration of transom lights/side lights



# TRANSOM LIGHTS AND SIDELIGHTS

Transom lights / sidelights are non-openable, glazed partitions between rooms, which can be an independent structure or a complement to interior doors (except for glass doors) with a fixed door frame. Transom lights /sidelights are manufactured and delivered as a set of elements to be assembled. The set includes:

- » two horizontal and two vertical main beams
- » set of cover and instalation strips
- » set of gaskets
- » main beam couplers

Transom lights/sidelights are used in interior doors with a fixed door frames and they come in the following decors DRE-Cell, 3D , CPL laminate 0,15-0,20 mm and painted.

**NOTE:** The offered product does not include the glass pane, it must be purchased separately. We recommend using 4 mm thick tempered glass pane. The installation of transom lights / sidelights should be carried out after the completion of "wet" construction works.

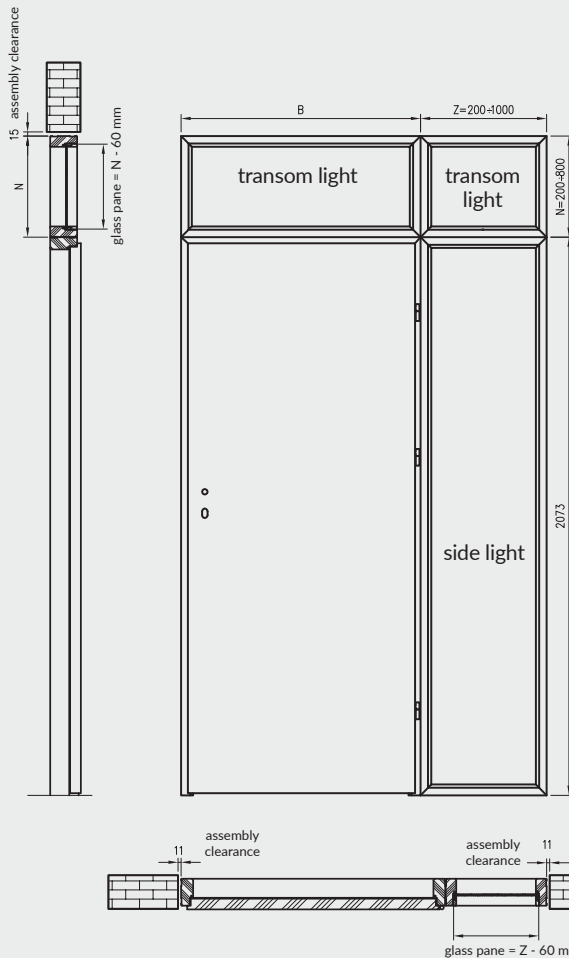
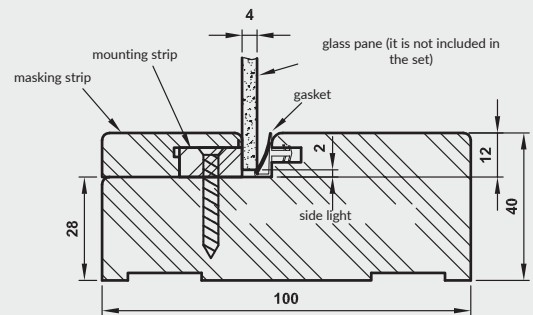

Fig. A cross-section of the transom light/sidelights



Dimensions of transom lights/sidelights

range of products	height total	width total	length of the perimeter
side light	2073 mm	Z	$2 \cdot 2073 + 2 \cdot Z$
sidelight	N	Z	$2 \cdot N + 2 \cdot Z$
transom light	N	B	$2 \cdot N + 2 \cdot B$

available options of transom lights heights

„N” = 200-800 mm.

available options of the width of transom and side lights

„Z” = 200-1000 mm.

Width of the upper "B" transom lights is adjusted to the width of the fixed door frames; the available options of the width of fixed door frames; available options of the widths can be found in the following tables:

The transom lights are mounted on the single-leaf door frame

	"60"	"70"	"80"	"90"	"100"	"110"
B	688	788	888	988	1088	1188

## Transoms mounted with the door frame in double-leaf doors

	„100d"	„110d"	„120"	„130"	„140"	„150"	„160"	„170"	„180"	„190"	„200"
B	1123	1223	1323	1423	1523	1623	1723	1823	1923	2023	2123

Price of the transom lights/sidelights is calculated per one meter of circumference measured on the outer side of the transom lights/sidelights.

To place an order please contact Atypical Orders Department - phn. 55 236 42 59.

**NOTE:** The height of the sidelight is adjusted to the standard height of a fixed door frame. Therefore, we do not recommend shortening the door frame in a configuration with the sidelights.

## STANDARD OPTIONS

- » door leaf frame made of MDF additionally reinforced with two flat metal bars
- » core made of tubular chipboard
- » external HDF board - flat or with decorative milling .
- » 3 silver screw-in pivot hinges
- » straight edge **Fig. 1** or edge R 2.5 mm (in CPL laminates, except for white, milky white, gray ) **Fig. 2**

## REBATED DOOR LEAF MODEL ENTER:

- » bottom deadbolt lock adapted for door lock cylinder
- » upper deadbolt lock adapted for door lock cylinder
- » Door leaves are available in the investment dimension "90E" (door frame passage with opened door leaf at 90° = 900mm)

## REBATED DOOR LEAF SOLID

- » multipoint mortise lock
- » hinges reinforced with anti-thrust bolts
- » Door leaves are available in the investment dimension "90E" (door frame passage with opened door leaf at 90° = 900mm)

## APPLICATION

Door leaf ENTER and SOLID can be used as internal entrance door in multifamily and in public utility buildings.

## CONSTRUCTION

The door leaf frame is made of MDF board, additionally reinforced with two steel flat bars. Filling - tubular chipboard. The doors have increased acoustic insulation ( $R_w = 32dB$ ), provided that thresholds or a dropping seal are used. HDF external board refined with DRE-Cell Decor - flat finish or with a decorative milling. **Door leaf models ENTER/SOLID are available with 0,7 mm CPL laminate - to place an order and for more information please contact Customer Service Department.**

**NOTE:** ENTER 0 and SOLID 0 - door leaves in CPL laminates as a standard with an edge radius R 2.5 mm except for white, milky white, gray.

It is recommended to use together with door leaf collection ENTER/SOLID fixed door frame ENTER/SOLID or metal door frames.

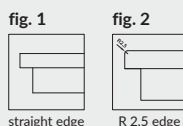

\* door handle and upper backplate METRO, set of cylinder lock inserts- single key system

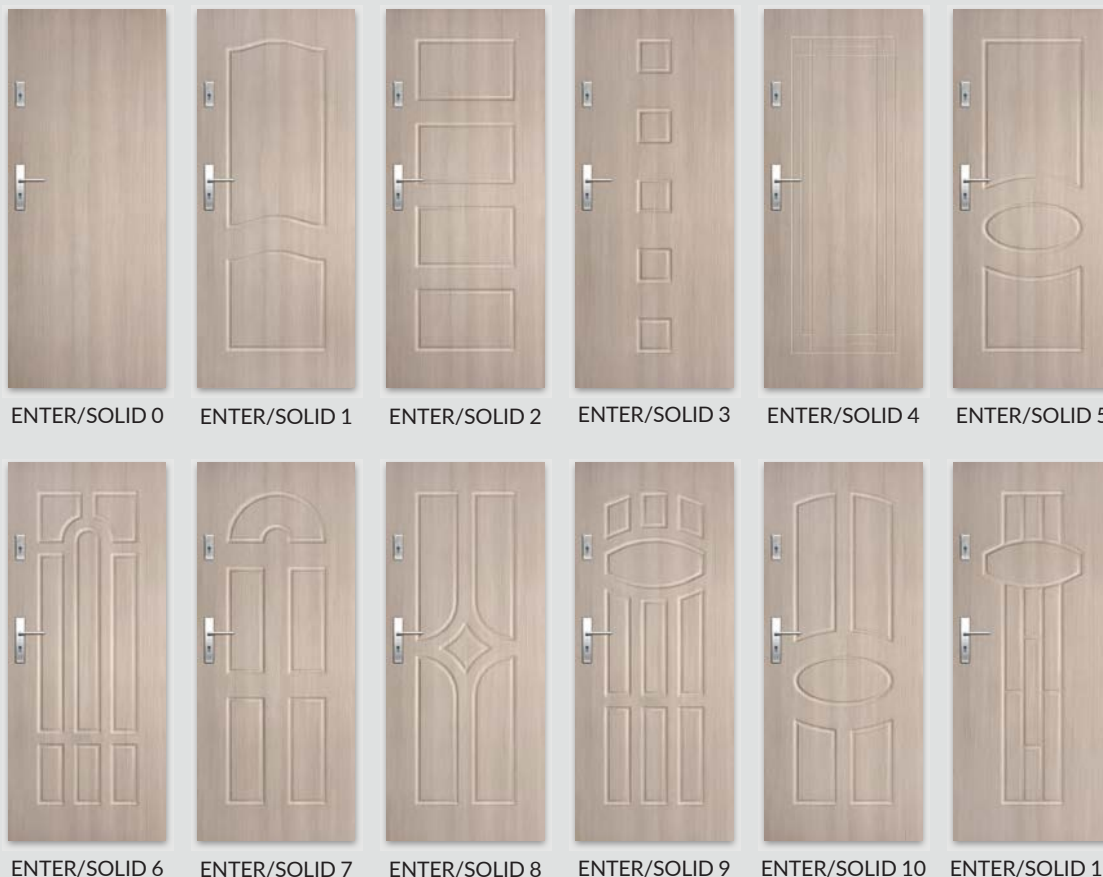



**OPTIONS AVAILABLE WITH EXTRA CHARGE**

- » viewfinder - included separately
- » digital viewfinder DDS1 - included separately
- » digital viewfinder DDS2 - separately
- » stainless steel threshold - width 70 mm
- » resignation from the second lock (Enter)
- » dropping seal

\*\*\* decor available only in horizontal wood grain  
\*while stock last

				light gray matt	white matt	silver	DRE-Cell Decor 1
white (textured)	white pine	siberian elm	sand oak	bleached oak textured	vintage oak	caramel walnut	DRE-Cell Decor 2
walnut	toffee oak***	marrone chestnut textured	evoked oak	golden oak textured	anthracite elm	dark wenge	
		grand oak	elm	walnut american	ebony*	Polish oak 3D	3D Decor
white	milky white	ashen	gray dark	concrete 2	gray oak	welsh oak	CPL Laminate
acacia	celini walnut	walnut	honey oak	chestnut	roasted walnut	black ST	

# ENTER/SOLID

REBATED DOOR LEAVES  
interior entrance



## STANDARD OPTIONS

- » door leaf frame made of MDF additionally reinforced with two flat metal bars
- » core made of tubular chipboard
- » external HDF board - flat or with decorative milling .
- » 3 silver screw-in pivot hinges
- » straight edge Fig. 1 or edge R 2.5 mm (in CPL laminates, except for white, milky white, gray ) Fig. 2

## REBATED DOOR LEAF MODEL ENTER:

- » bottom deadbolt lock adapted for door lock cylinder
- » upper deadbolt lock adapted for door lock cylinder
- » Door leaves are available in the investment dimension "90E" (door frame passage with opened door leaf at 90° = 900mm)

## REBATED DOOR LEAF SOLID

- » multipoint mortise lock
- » hinges reinforced with anti-thrust bolts
- » Door leaves are available in the investment dimension "90E" (door frame passage with opened door leaf at 90° = 900mm)

## APPLICATION

Door leaf ENTER and SOLID can be used as internal entrance door in multifamily and in public utility buildings.

It is recommended to use together with door leaf collection ENTER/SOLID fixed door frame ENTER/SOLID or metal door frames.

## CONSTRUCTION

The door leaf frame is made of MDF board, additionally reinforced with two steel flat bars. Filling – tubular chipboard. The doors have increased acoustic insulation (Rw = 32dB), provided that thresholds or a dropping seal are used. HDF external board refined with DRE-Cell Decor - flat finish or with a decorative milling.

fig. 1



straight edge

fig. 2



R 2.5 edge



ENTER/SOLID 12 ENTER/SOLID 13 ENTER/SOLID 14 ENTER/SOLID 15 ENTER/SOLID 16 ENTER/SOLID 17



ENTER/SOLID 18 ENTER/SOLID 19\* ENTER/SOLID 20\* ENTER/SOLID 21\*\* ENTER/SOLID 22\*\* ENTER/SOLID 23\*\*

\* in models 19 and 20 veneer is glued in strips with variable wood grain.



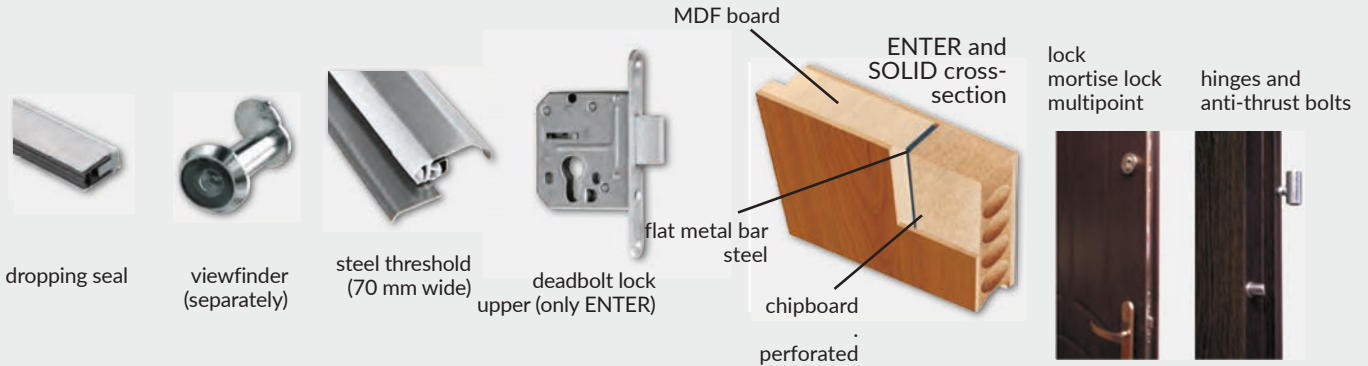

NOTE: models ENTER 21-23 and SOLID 21-23 - door leaves in CPL laminates and edge with R 2,5 mm radius as a standard.

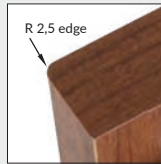
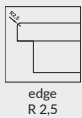

\*\*in 21-23 models there are 8mm inserts located in one plane with the door leaf surface on both sides



digital viewfinder (separately)    DDS1    digital viewfinder DDS2 (separately)

\*\*\* decor available only in horizontal wood grain  
\*while stock last

				light gray matt	white matt	silver	DRE-Cell Decor 1
white (textured)	white pine	siberian elm	sand oak	bleached oak textured	vintage oak	caramel walnut	DRE-Cell Decor 2
walnut	toffee oak***	marrone chestnut textured	evoke oak	golden oak textured	anthracite elm	dark wenge	
		grand oak	elm	walnut american	ebony*	Polish oak 3D	3D Decor
white	milky white	ashen	gray dark	concrete 2	gray oak	welsh oak	CPL Laminate
acacia	celini walnut	walnut	honey oak	chestnut	roasted walnut	black ST	



SOLID RC2 - gray oak CPL

## STANDARD OPTION:

- » door leaf frame made of soft wood
- » core made of full chipboard
- » straight edge
- » multipoint mortise lock
- » anti-thrust bolts
- » 3 triple hinges
- » HDF external board with aluminum sheet

SOLID RC2 doors have an acoustic insulation class of  $R_w=32dB$  and burglary resistance of class RC2 according to PN-EN 1627:2012, provided that the door leaf is completed with a steel door frame, a steel threshold and a separately purchased, dedicated set of fittings: door handle, long backplate and cylinder inserts. Photo of the door handle and long backplate, page 166.

## APPLICATION

Door leaf SOLID RC2 can be used as internal entrance door in multifamily buildings and in public utility buildings. They can be used with door frames:

- » OSS (steel fixed door frame) information and prices - page 150
- » OSR (steel adjustable door frame) information and prices - page 152
- » OSH (steel hybrid door frame) information and prices - page 156

## OPTIONS AVAILABLE WITH EXTRA CHARGE

- » viewfinder - separately
- » "100" door leaves
- » steel threshold
- » ONTARIO door handle
- » ONTARIO backplate
- » cylinder lock insert (price for 2 pcs.)

## OPTIONS WITHOUT EXTRA CHARGE

Door leaves are available in the investment dimension "90E"  
(door frame passage with opened door leaf at  $90^\circ$   
= 900mm)

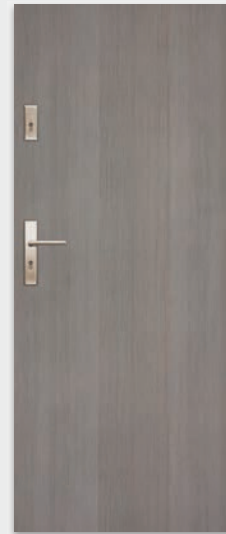

SOLID RC2



threefold hinge E878



Door frames colours are in two gloss scale (matt/low structure, semi gloss/plain).

# FIRE RESISTANT DOOR LEAF ATHOS



REBATED

Interior entrance door

## ATHOS TECHNICAL DOORS MEET THE FOLLOWING REQUIREMENTS:

- » fire resistance class: EI30 with a steel door frame
- » fire resistance class: EI30 with a wooden door frame
- » smoke proof class: Sa, S<sub>200</sub>
- » mechanical resistance class: 3
- » sound insulation class: RW=32 dB
- » acoustic insulation class: Rw = 37 dB with a wooden door frame and wooden threshold

## APPLICATION

Interior entrance fire-resistance doors, are used in residential housing, public utility buildings and collective residential buildings, as well as commercial and technical premises.

## STANDARD OPTION

- » door leaf frame made of soft wood
- » core made of full chipboard
- » straight edge
- » single-point mortise lock adapted for cylinder lock
- » 3 triple hinges

## DOOR FRAMES

- » steel fixed door frame p. 151
- » steel adjustable door frame p. 153
- » steel hybrid door frame, page 157
- » wooden door frame p. 125

## OPTIONS AVAILABLE WITH EXTRA CHARGE

- » DORMA TS-71 selfcloser
- » DORMA TS-90 selfcloser
- » GEZE TS 2000 selfcloser
- » door leaf "100" (for 0.7 mm laminate)
- » door leaves "100" "110" (for 0.15-0.2 mm laminates)
- » viewfinder
- » wooden threshold

In order to comply with the conditions of the National Technical Assessment, doors with fire resistance EI 30 should be equipped with a selfcloser.

**NOTE:** The price of the door leaf does not include the price of a steel frame or a wooden frame.

Door leaves with a width of "110" in 0.7 mm laminates available after individual pricing by the Contract Department.



ATHOS 10

CPL  
Laminate

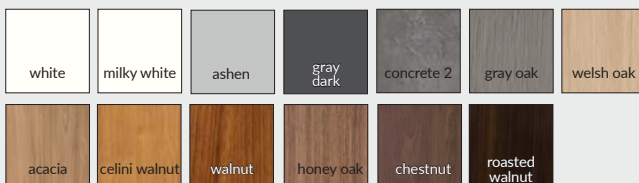

## CONSTRUCTION

The OD ATHOS wooden door frame is made of glued pine wood, covered with CPL O laminate, 15-0.2 mm on the display side. The door frame beams with a constant width of 100 mm, are cut at an angle of 90°. An intumescent seal with fire-resistance properties is glued into the channel, milled in the beam rebate.

## APPLICATION

OD ATHOS wooden door frames are dedicated to Athos doors, and when installed in accordance with the National Technical Assessment No. 2018/0633, they constitute together with ATHOS door leaf a partition with fire resistance class EI<sub>1</sub> 30. Moreover, equipped with a fixed threshold, they meet the acoustic insulation criteria in accordance with  $R_w = 37$  dB class, and in the configuration with a dropping seal, without a fixed threshold,  $R_w = 32$  dB class.

## SET CONTAINS

- » Main beams (upper beam, latch strike plate beam with installed main lock latch strike plate and hinge beam with the sockets and three-part hinges and mounted anti-burglary bolt sockets), rebate seal, three hinges (middle part of the three-part hinge) + 3 hinge sockets, set of elements to assemble the door frame according to the attached instructions.

The door frames are packed in a cardboard packaging.

Assortment of wooden frames:

- » OD ATHOS - for Athos door with a fixed threshold
- » OD ATHOS UO - for Athos doors with a dropping seal

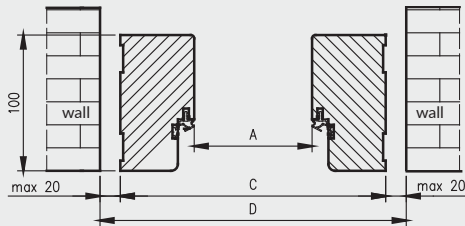

OD dimensions for Athos doors

width.	A	C	D
"80"	802	910	934
"90"	902	1010	1034
"90E"	917	1025	1049
"100"	1002	1110	1134
"110"	1102	1210	1234

D - width of the assembly hole

Wooden door frame for Athos door with a fixed threshold

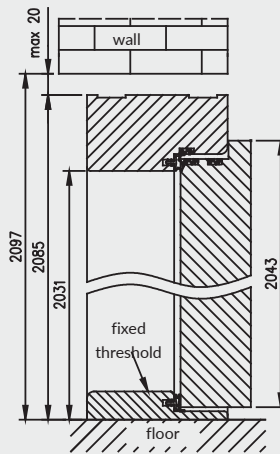

Wooden door frame for Athos door with dropping seal \*

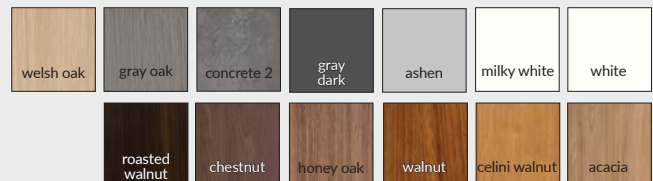
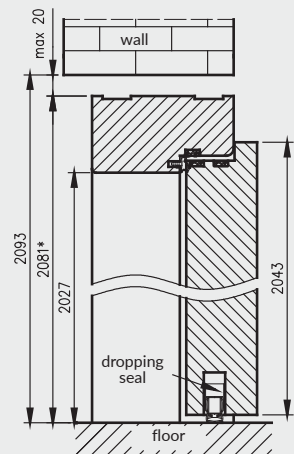

CPL  
Laminate



## FORCA TECHNICAL DOORS MEET THE FOLLOWING REQUIREMENTS:

- » class of anti-burglary:  
RC3 (according to PN-EN 1627: 2012)
- » fire resistance class: EI<sub>30</sub>
- » smoke proof class: Sa, S<sub>200</sub>
- » mechanical resistance class: 3
- » acoustic insulation class: Rw = 37 dB with a steel frame and a metal threshold

## APPLICATION

Fire-resistant and anti-burglary interior entrance doors, used in residential buildings, public buildings and collective housing buildings, as well as utility and technical rooms. The door is sold only as a set with a steel door frame, a steel threshold, a door handle, a long backplate and two cylinder inserts.

## STANDARD OPTION

- » door leaf frame made of soft wood
- » core made of full chipboard
- » straight edge
- » steel strings
- » 5-point mortise lock
- » 3 triple hinges

## DOOR FRAMES

- » steel fixed door frame p. 151
- » steel adjustable door frame p. 153
- » steel hybrid door frame, page 157

## OPTIONS AVAILABLE WITH EXTRA CHARGE

- » steel threshold
- » handle-handle F1 color\*
- » long backplate F1 color\*
- » patent cylinder x 2 pcs.
- » DORMA TS-71 selfcloser
- » DORMA TS-90 selfcloser
- » GEZE TS 2000 selfcloser
- » door leaf „100”
- » viewfinder

In order to meet the conditions of the National Technical Assessment for fire resistance doors with EI 30 and anti-burglary class - a self closer and DIVA door handle with a long backplate must be used. Photo of the door handle and a long backplate - page 166.

**NOTE:** The price of the door leaf should be increased by the price of steel door frame, steel threshold, door handle, backplate and two pcs. of cylinder lock inserts.

\* - F8 black anode color, available for contract orders, after consultation and individual price verification with the Investment Department.



FORCA 10

CPL Laminate





### FORCA B TECHNICAL DOORS MEET THE FOLLOWING REQUIREMENTS:

- » class of anti-burglary:  
RC3 (according to PN-EN 1627: 2012)
- » mechanical resistance class: 3
- » acoustic insulation class:  $R_w = 37$  dB with a steel frame and a metal threshold

### APPLICATION

Interior entrance doors, with anti-burglary class, used in residential buildings, public buildings and collective housing buildings, as well as utility and technical rooms. The door is sold only as a set with a steel door frame, steel threshold, door handle and long backplate.

### STANDARD OPTION

- » door leaf frame made of soft wood
- » core made of full chipboard
- » straight edge
- » steel strings
- » 5-point mortise lock
- » 3 triple hinges

### DOOR FRAMES

- » steel fixed door frame p. 151
- » steel adjustable door frame p. 153
- » steel hybrid door frame, page 157

### OPTIONS AVAILABLE WITH EXTRA CHARGE

- » steel threshold
- » handle-handle F1 color\*
- » long backplate F1 color\*
- » patent cylinder x 2 pcs.
- » door leaf „100”
- » viewfinder

**NOTE:** The price of the door leaf should be increased by the price of steel door frame, steel threshold, door handle, backplate and two pcs. of cylinder lock inserts.

\* - F8 black anode color, available for contract orders, after consultation and individual price verification with the Investment Department.



FORCA B 10

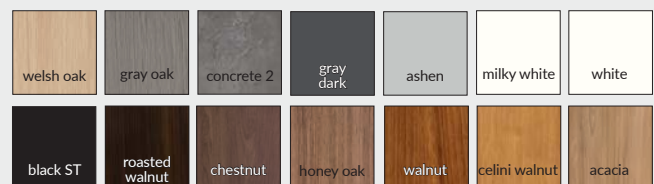

CPL Laminate



OLIMP 10 - white matt

CPL Laminate

white	milky white	ashen	gray dark	concrete 2	gray oak	welsh oak
acacia	celini walnut	walnut	honey oak	chestnut	roasted walnut	



## STANDARD OPTIONS

- » core made of Halspan chipboard 44 mm in EI30 or 54 mm in EI60 with additional pine wood strips attached circumferentially
- » straight edge, rounded glass pane frame **fig.1**
- » transparent fire - resistance glass pane (variable width dependent upon the size of the door leaf)
- » intumescent smoke-proof gasket
- » 3 hinges
- » cylinder lock
- » dropping seal

fig. 1



fixed edge



rounded glass pane frame  
22x28 mm



fire-resistant ventilation grille.



GEZE TS 2000 self closer



DORMA self closer  
TS-71



DORMA TS-90 impuls self closer



Acoustic sound insulation class for single leaf door  $R_w=32$  dB  
Acoustic sound insulation rate for double leaf door  $R_w=27$  dB

NOTE: In door leaf with fire-resistance EI30 there are used three triple hinges, while in door leaf with fire resistance EI60 there are used VX7939 hinges.

## OPTIONS AVAILABLE WITH EXTRA CHARGE

- » viewfinder
- » DORMA TS-71 selfcloser
- » DORMA TS-90 selfcloser
- » GEZE TS 2000 selfcloser
- » fire resistance ventilation grille.
- » extra charge for passive door leaf

## APPLICATION

Fire-resistance doors are used as interior entrance doors in residential housing, public utility buildings and collective residential buildings. In order to comply with the conditions of the National Technical Assessment self closer should be applied in doors with fire-resistance EI30 and EI60.



OLIMP 10



OLIMP 20

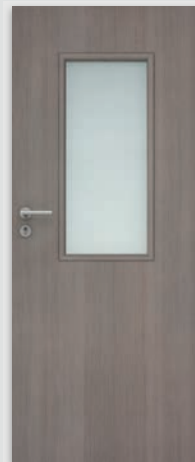

OLIMP 30

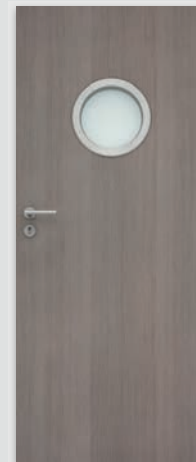

OLIMP 40

# OLIMP EI 60 STEEL FIXED DOOR FRAME

## DOOR FRAME CONSTRUCTION

Steel door frame made of 1.5 mm thick structural carbon steel sheet, welded construction, powder coated.

## APPLICATION

Door frame is applied to the interior entrance fire-resistance doors OLIMP EI60.

## STANDARD OPTIONS

- » 3 hinges
- » gasket with enhanced flame-resistance properties

OLIMP EI-60 door leaf vertical cross-section

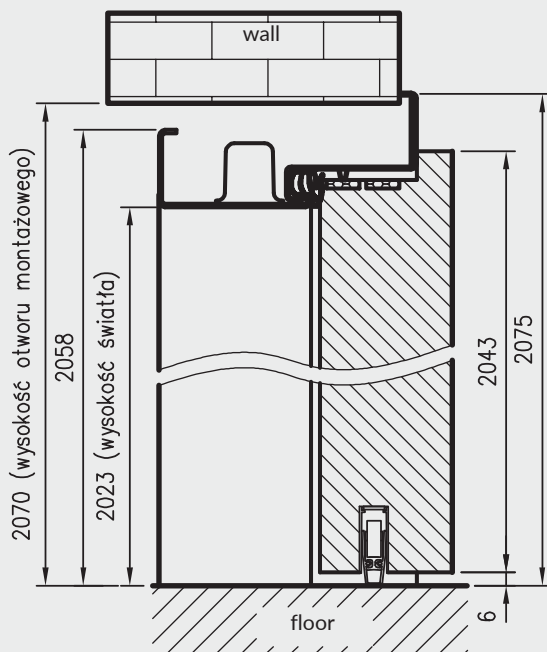

horizontal cross-section of door frame mounted in the wall

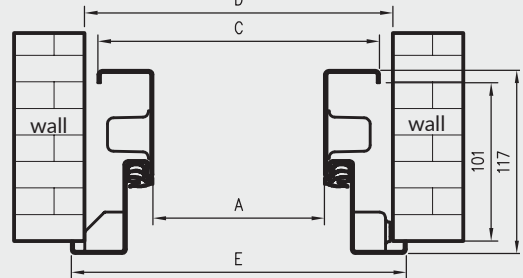

D - width of the assembly hole

door frame profile

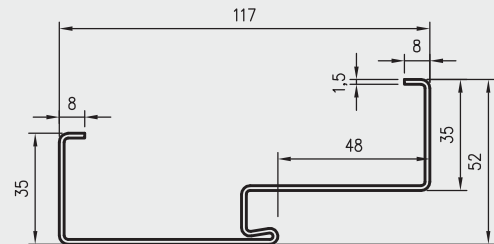

Olimp EI60 dimensions for single leaf doors

	A	C	D	E
"80"	797	867	884	901
"90"	897	967	984	1001
"90E"	926	996	1013	1030
"100"	997	1067	1084	1101
"110"	1097	1167	1184	1201

Olimp EI60 dimensions for double leaf doors

	A	C	D	E
"160"	1633	1703	1720	1737
"170"	1733	1803	1820	1837
"180" = "90" + "90"	1833	1903	1920	1937
"200" = "100" "100"	2033	2103	2120	2137
"210"	2133	2203	2220	2237
"220"	2233	2303	2320	2337

## AVAILABLE COLOURS

Door frame is powder coated in two gloss scale (matt / low structure or semi-gloss / plain). There are available colours:

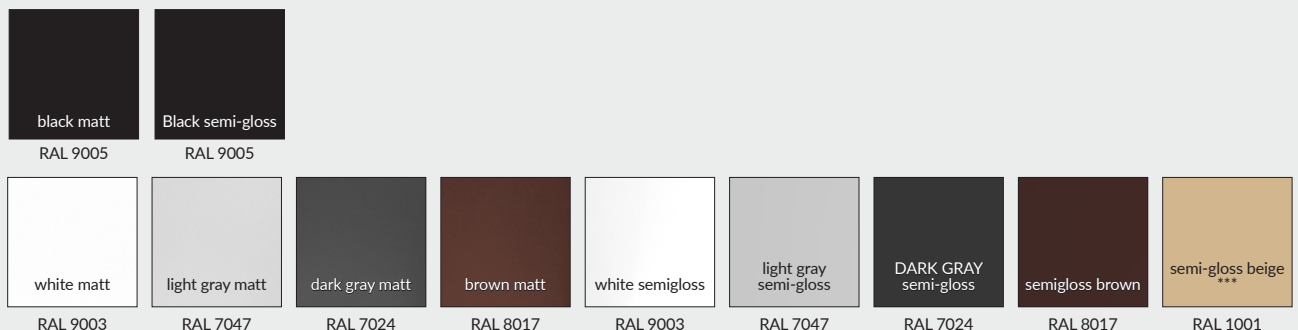

\*\*\* beige colour is available only in semi-gloss



threefold hinge



Hinge SIMONSWERK VX 7939/160 (for door widths "100" and "110")

# WOODEN FIRE RESISTANT DOOR FRAME

For OLIMP EI 30 and EI60 doors

## CONSTRUCTION

Fixed wooden door frame with a cross-section of 54x100 mm (54x120mm for Olimp EI 60 doors) made of coniferous plywood laminated with a 0.2mm CPL laminate in the color of the door leaf.

## APPLICATION

The door frame is used for interior fire-resistant entrance doors:

- OD OLIMP EI30 wooden door frame - for Olimp EI 30 doors
- OD OLIMP EI60 wooden door frame - for Olimp EI 60 doors

## STANDARD OPTIONS

- » 3 hinges
- » gasket with enhanced flame-resistance properties
- » latch strike plate
- » mounting kit

Cross-section of the wooden door frame for OLIMP EI30 doors

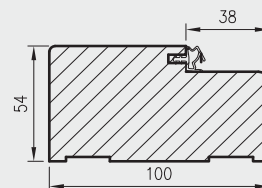

Cross-section of the wooden door frame for OLIMP EI60 doors

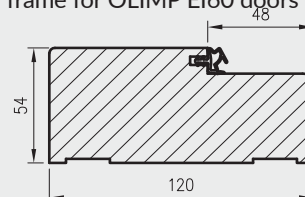

vertical cross-section of fire-resistance door leaf.

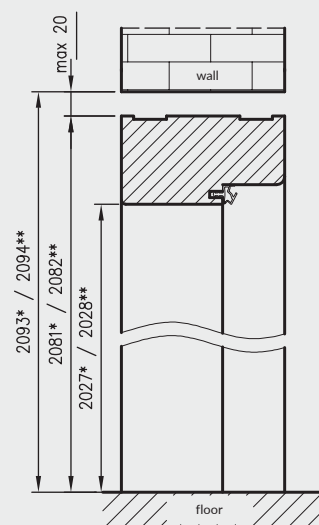

horizontal cross-section door frame in the wall

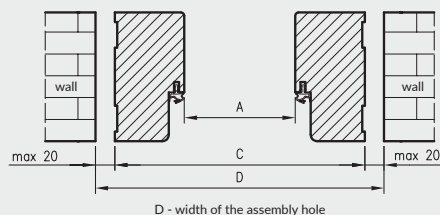

D - width of the assembly hole

\* dimensions of OD OLIMP EI 30 wooden door frame

\*\* dimensions of OD OLIMP EI 60 wooden door frame

OD OLIMP EI30 wooden door frame for single-leaf doors

	A	C	D
80	802	910	934
90	902	1010	1034
90E	917	1025	1049
100	1002	1110	1134
110	1102	1210	1234

OD OLIMP EI30 wooden door frame for double-leaf doors

	A	C	D
160	1637	1745	1769
170	1737	1845	1869
180	1837	1945	1969
190	1937	2045	2069
200	2037	2145	2169

OD OLIMP EI60 wooden door frame for single-leaf doors

	A	C	D
80	804	912	936
90	904	1012	1036
90E	933	1041	1065
100	1004	1112	1136
110	1104	1212	1236

OD OLIMP EI60 wooden door frame for double-leaf doors

	A	C	D
160	1640	1748	1772
170	1740	1848	1872
180	1840	1948	1972
200	2040	2148	2172

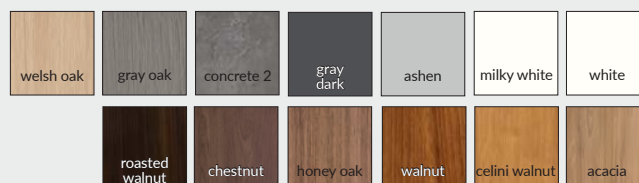

CPL Laminate

## ENTER ACOUSTIC TECHNICAL DOORS MEET THE FOLLOWING REQUIREMENTS:

- » mechanical resistance class: 3
- » sound insulation class  $R_w = 32\text{dB}$

## APPLICATION

Door leaf ENTER ACOUSTIC are designed to be used as interior entrance door in multifamily buildings and in public utility buildings

## STANDARD OPTION:

- » door leaf frame made of MDF additionally reinforced with two flat metal bars
- » core made of tubular chipboard
- » flat external HDF board
- » dropping seal
- » 3 silver screw-in pivot hinges
- » R2.5mm edge (available only in CPL laminates, except for white, milky white and gray laminates) or straight edge
- » bottom deadbolt lock adapted for door lock cylinder
- » Door leaves are available in the investment dimension "90E" (door frame passage with opened door leaf at  $90^\circ = 900\text{mm}$ )

## DOOR FRAMES:

- » steel hybrid door frame, page 157
- » steel adjustable door frame p. 153
- » steel fixed door frame p. 151
- » fixed rebated door frame p. 136
- » adjustable door frame with T80, T63 architrave p. 138

## OPTIONS AVAILABLE WITH EXTRA CHARGE:

- » viewfinder - included separately
- » door leaves "110" except for 0.7 mm laminates

Door leaves with a width of "110" in 0.7 mm laminates available after individual pricing by the Contract Department.

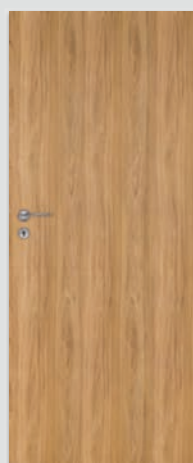

ENTER 0 ACOUSTIC

DRE-Cell Decor 1	silver	white matt	light gray matt																			
DRE-Cell Decor 2	dark wenge	anthracite elm	golden oak textured	caramel walnut	vintage oak	bleached oak textured	sand oak															
	evoked oak	marrone chestnut textured	toffee oak***	walnut	siberian elm	white pine	white (textured)															
3D Decor	Polish oak 3D	ebony*	walnut american	elm	grand oak																	
CPL Laminate	roasted walnut	chestnut	honey oak	walnut	celini walnut	acacia	welsh oak	gray oak	concrete 2	gray dark	ashen	milky white	white	black ST								

\* decor available while stocks last \*\*\* decor only in horizontal grain



GALLA 1  
transparent



GALLA 1  
decormat



GALLA 1  
decormat brown



GALLA 1  
decormat graphite



GALLA 2  
sand blasted glass  
transparent strips

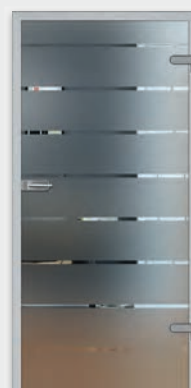

GALLA 3  
sand blasted glass  
transparent strips



GALLA 10  
decormat  
screen printing



GALLA 10  
transparent glass  
screen printing



GALLA 11  
decormat  
screen printing



GALLA 11  
transparent glass  
screen printing



GALLA 12  
decormat  
screen printing



GALLA 13  
decormat  
screen printing

Door leaf is made of tempered, 8mm glass pane.

**OPTIONS AVAILABLE WITH EXTRA CHARGE**

- » ventilation undercut available in swing door leaf  
( in "80" and "90" meets ventilation requirements)

# FITTINGS FOR GLASS DOORS

DOOR LEAF

## SELECTION OF LOCKS FOR GLASS DOORS

Glass door locks are universal, they can be configured for left or right sided doors.

In the case of locks in the "toilet" version (with a bathroom knob) - the term "left" or "right" refers to the direction of opening the door: into the bathroom - left lock or into the corridor - right lock (see Fig. 1-4):

Fig. 1-2. For doors opening into the bathroom, select the left lock. Fig. 3-4. Doors opening into the corridor, select the right lock

Fig. 1. right door / outside lock

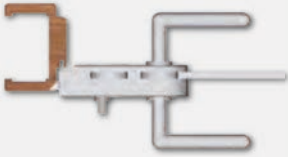

fig. 2 left door leaf/blockade outside

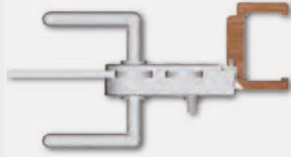

fig. 3 right door leaf/blockade inside

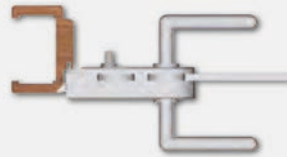
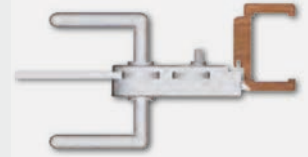

fig. 4 left door leaf/blockade inside



## HARDWARE



silver lock



silver lock toilet\*\*\*



silver lock simple key lock



silver lock cylinder lock\*\*



silver hinge



steel lock



steel lock \*\*\*



steel lock simple key lock



steel lock cylinder lock\*\*



steel hinge



black lock



black lock \*\*\*



black lock simple key lock



black lock cylinder lock\*\*



hinge black

\*\* It is necessary to purchase cylinder insert 21/26 separately (see details in the above table)

\*\* Toilet lock - selection of toilet lock see details above

## DOOR LEAF DIMENSIONS AND PLACEMENT OF HARDWARE

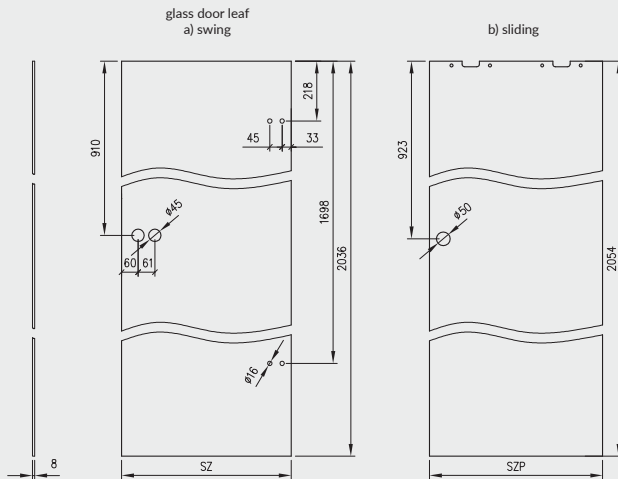

The leaf is a glass pane, made of safe, uniform tempered glass, 8 mm thickness, with holes for mounting:

- » hinges and lock in swing doors leaf
- » round door handle and hardware adapted for sliding system door leaf

## APPLICATION

Glass door leaf are used as interior doors in residential housing, public utility buildings and collective residential buildings.

## OPENING DIRECTION OF GLASS DOOR LEAF

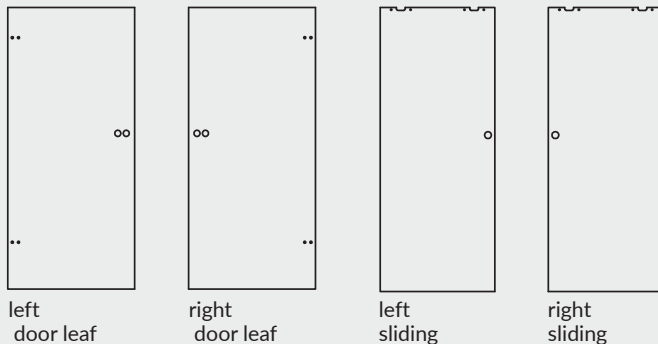

There are two different sides of glass pane in Galla door leaves (does not refer to transparent Galla1).

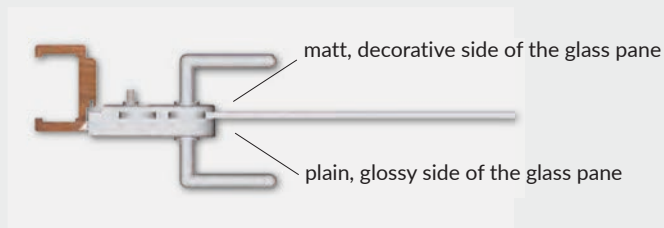

## DOOR LEAF WIDTH

Symbol of the door dimension	SZ	SZP
"60"	617	630
"70"	717	730
"80"	817	830
"90"	917	930

SZ - width of glass swing door leaf

SZP - width of glass sliding door leaf

## DOOR LEAF HEIGHT

2036 mm - height of glass swing door leaf

2054 mm - height of glass sliding door leaf

**NOTE:** There is no possibility to shorten glass door leaf.

## CLEARANCE BETWEEN DOOR LEAF AND FLOOR

Standard clearance between door leaf unit and ready floor is 8 mm.

## NOTES REFERED TO HINGE

DOOR FRAMES applied to glass doors should be equipped with two pivot  $\varnothing 15$  mm.

## FULFILMENT OF VENTILATION REQUIREMENTS FOR GLASS DOORS

symbol dim. DOORS	doors with ventilation undercut	
	ventilation surface of the undercut and the clearance 8 mm [m <sup>2</sup> ]	required clearance to meet ventilation requirements [in mm]
"90"	0,027	2
"80"	0,024	5,5
"70"	0,021	10*
"60"	0,017	16*

\* - door leaf „60" and „70" doesnt meet ventilation requirements.

Ventilation undercut (only active door leaf)

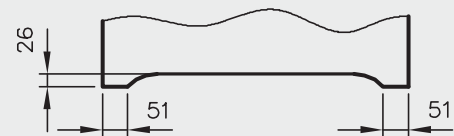

In order to meet ventilation requirement - total ventilation surface 0,022 m<sup>2</sup>, there must be used ventilation undercut in active glass door leaf with "80" - "90" width and standard clearance between door leaf and floor (8mm) .

# FIXED DOOR FRAMES

REBATED

## CONSTRUCTION

Fixed door frame is made of high-quality wood-based board and it is coated with ecological, wood-like decorative DRE-Cell veneer, 3D veneer, 0,15 - 0,20 mm CPL, finish veneer or painted.

Door frames has fixed width of 100 mm.

## APPLICATION

Fixed door frame can be used in the following types of doors:

- » ENTER entrance doors (equipped with 3 ø 13,5 mm hinges and additional upper latch plate)
- » SOLID entrance doors (equipped with 3 ø 13,5 mm hinges and 4 hooks for the latch and latches of the flat multi-point lock)
- » glass doors ("OPC" they are equipped with two hinges ø 15 mm, special latch plate and rubber seal strip)
- » other remaining rebated door leaf (using 2 or 3 ø 13,5 mm hinges, in all frame construction door and panel door collections having size "90" and wider; door frames should be equipped with 3 hinges)

Masking architraves are used in fixed door frames and SOFT door frames, whereas for natura fixed SOFT door frames angular architrave are used.

## THE SET CONTAINS

Main beam (horizontal element and two vertical elements), door seal, set of hinges, set of elements intended for assembling the door frame according to the attached instructions. Door frames are packed in cardboard boxes.

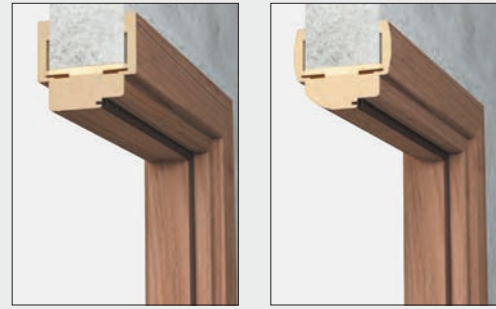

OP profile

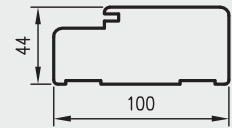

OP SOFT profile

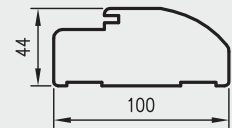

OP vertical cross-section for rebated door leaf

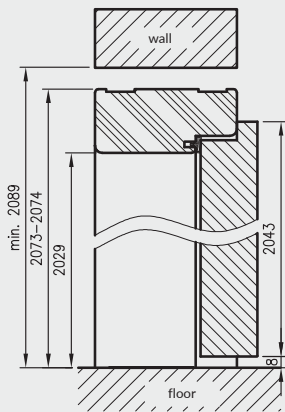

required height of wall passage 2089 mm (2095 mm for glass doors)

OP vertical cross-section for glass doors

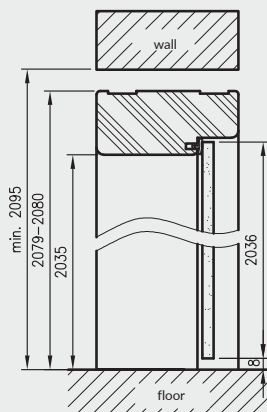

OP Horizontal cross section

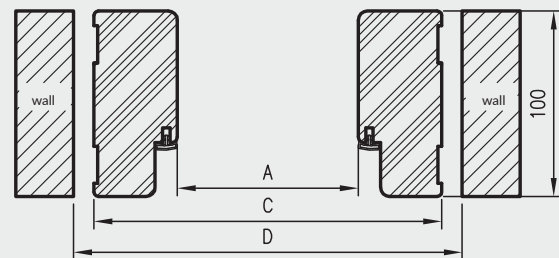

for single-leaf doors

	A	C	D
"60"	600	688	712
"70"	700	788	812
"80"	800	888	912
"90"	900	988	1012
"90E"	904	992	1016
"100"	1000	1088	1112
"110"	1100	1188	1212

for rebated door leaf double-leaf doors

	A	C	D
„100d"	1035	1123	1147
„110d"	1135	1223	1247
„120"	1235	1323	1347
„130"	1335	1423	1447
„140"	1435	1523	1547
„150"	1535	1623	1647
„160"	1635	1723	1747
„170"	1735	1823	1847
„180"	1835	1923	1947
„190"	1935	2023	2047
„200"	2035	2123	2147

\* door frames for glass doors, width "60" - "90"  
D - required width of wall opening

## OPTIONS AVAILABLE WITH EXTRA CHARGE

- » door frame ENTER (with latch deadbolt plate)
- » door frame SOLID
- » door frame for double leaf door: +30%



# FIXED DOOR FRAMES

NON-REBATED

## CONSTRUCTION

Fixed non-rebated door frame is made of high-quality wood-based board and it is coated with ecological, wood-like decorative DRE-Cell veneer, 3D veneer, 0,15 - 0,20 mm CPL or painted. Door frames has fixed width of 100 mm.

## APPLICATION

Fixed non-rebated door frame can be applied to all DRE collections which are available in non-rebated option.

## SET CONTAINS

Main beam (horizontal element and two vertical elements), door seal, set of hinges, set of elements intended for assembling the door frame according to the attached instructions. Door frames are packed in cardboard boxes.



OPB vertical cross-section

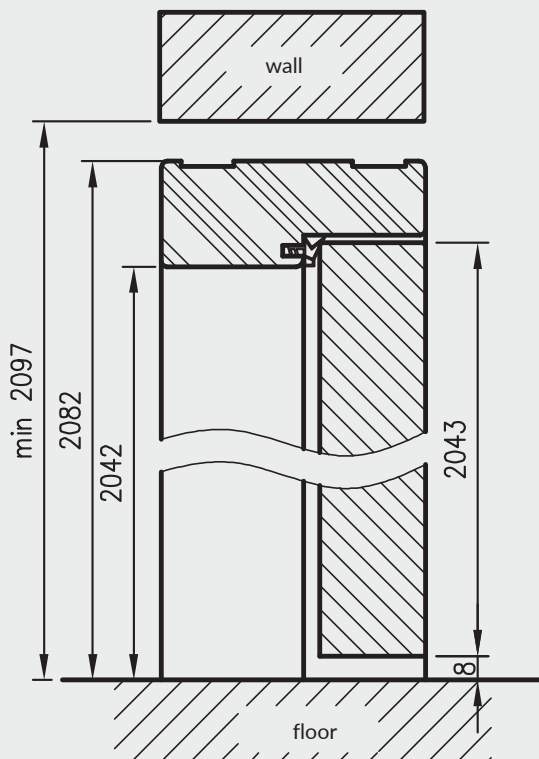

required height of the wall opening 2097 mm

D - required width of wall opening

OPB Horizontal cross section

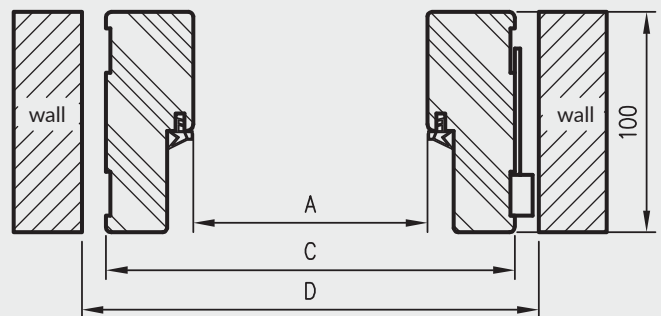

OPB profile

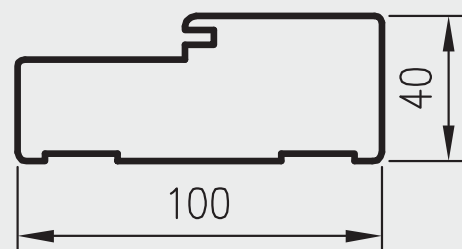

for single-leaf doors

	A	C	D
"60"	627	707	730
"70"	727	807	830
"80"	827	907	930
"90"	927	1007	1030
"100"	1027	1107	1130

for double-leaf doors

	A	C	D
„120"	1274	1354	1380
„130"	1374	1454	1480
„140"	1474	1554	1580
„150"	1574	1654	1680
„160"	1674	1754	1780
„170"	1774	1854	1880
„180"	1874	1954	1980

Prices include 2 hinges with assembly plates.

Price of the double-leaf door frame: + 50% (if 3 hinges are used, there is extra charge )

» Additional payment for the third hinge Estetic 80

# ADJUSTABLE DOOR FRAMES

REBATED WITH T80 OR T63 ARCHITRAVE

## CONSTRUCTION

The adjustable door frame with T80 or T63 architrave is equipped with angle brackets with small rounding radii of the cross profile. It is made of high-quality wood-based board. On the display side, it is entirely covered with wood-like decorative foil DRE-Cell Decor, 3D foil, and CPL laminate thickness. 0.15 - 0.2 mm or painted \*\*. Its design allows for use on walls with a thickness of 60 - 320 mm. Connecting at a 90° angle is available with T80 architrave in **white matt, black 2 matt, white UV acrylic painted, white pine, sand oak, 3D Polish oak**.

\*\*NOTE: To ensure the highest quality of painted door frames, before painting process they are coated with special material which constitutes solid base.

## APPLICATION

Adjustable door frame can be applied for:

- » interior door leaves - rebated and for glass door leaves (ORC)
- » entrance doors ENTER ( includes 3 hinges ø 13, 5 mm, additional latch plate - extra charge net)

## SET CONTAINS

Main beam (one horizontal and two vertical elements together with masking elements), door seal, set of hinges, all necessary components for the installation of door frames in accordance with the supplied instruction. Door frames are packed in cardboard boxes.

Door frames are packed in cardboard boxes.

All door frames for the frame construction doors and door frames 90 mm and wider should be equipped with 3 hinges. Glass door frames are equipped with 2 hinges ø 15 mm, a special catch and a seal.



OR (adjustable rebated door frame) with T63



OR (adjustable rebated door frame) with T80

Price of adjustable door frame for double leaf door: +30%

The door frame for wall thickness 060-075 has got a shallower milling on the movable architrave side during assembly it is necessary to shorten the tongue of the architrave.

Extra charge for 90° joining in white matt, black matt 2, white UV acrylic varnish, white pine, sand oak, Polish 3D oak

Extra charge for reinforcement for self closer applies to door frames with 45° connection angle<sup>about</sup>

# ADJUSTABLE DOOR FRAMES

REBATED WITH T80 OR T63 ARCHITRAVE

Cross-section of rebated door frame OR/ door frame for glass doors ORC with the architrave. T63

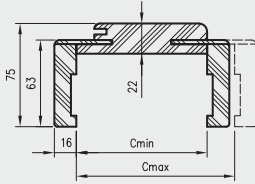

Cross-section of rebated door frame OR/ door frame for glass doors ORC with the architrave. T80

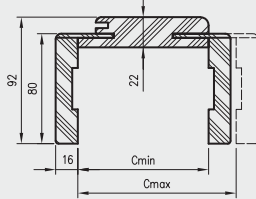

OR/ORC horizontal cross-section

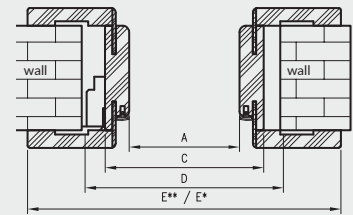

D - required width of wall opening

vertical cross-section of rebated door leaf with OR

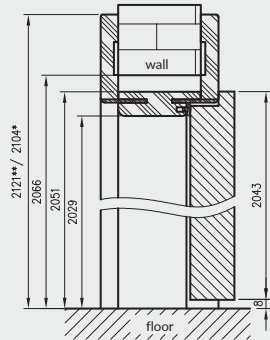

for double-leaf doors

	A	C	D	E**	E*
100d	1035	1079	1115	1219	1185
110d	1135	1179	1215	1319	1285
120	1235	1279	1315	1419	1385
130	1335	1379	1415	1519	1485
140	1435	1479	1515	1619	1585
150	1535	1579	1615	1719	1685
160	1635	1679	1715	1819	1785
170	1735	1779	1815	1919	1885
180	1835	1879	1915	2019	1985
190	1935	1979	2015	2119	2085
200	2035	2079	2115	2219	2185

for single-leaf doors

	A	C	D	E**	E*
60	602	646	680	786	752
70	702	746	780	886	852
80	802	846	880	986	952
90	902	946	980	1086	1052
90E	906	950	984	1090	1056
100	1002	1046	1080	1186	1152
110	1102	1146	1180	1286	1252

Adjustable door frame connection at an angle of 90° T80 architrave

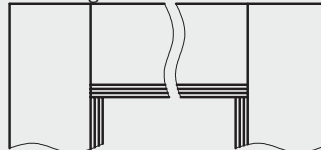

Joining at an angle of 90° available in white matt, black matt 2, white painted acrylic UV, white pine, sand oak, Polish 3D oak.

vertical cross-section of glass doors with ORC

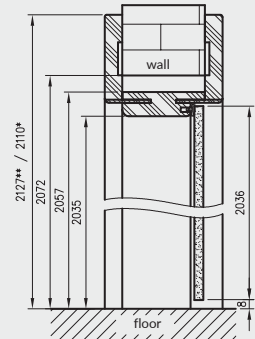

required wall passage height 2066 mm (2072 mm for glass doors)

Black ST decor available only with T80 architrave

Price of adjustable door frame for double leaf door: +30%

The door frame for wall thickness 060-075 has got a shallower milling on the movable architrave side during assembly it is necessary to shorten the tongue of the architrave.

Extra charge for 90° joining in white matt, black matt 2, white UV acrylic varnish, white pine, sand oak, Polish 3D oak

Extra charge for reinforcement for self closer applies to door frames with 45° connection angle about

2nd group CPL - CPL laminate natural halifax oak.

# NON-REBATED ADJUSTABLE DOOR FRAMES

NON-REBATED WITH T80 OR T63 ARCHITRAVE

## CONSTRUCTION

The non-rebated adjustable door frame is made of high-quality wood-based board. On the display side, it is entirely covered with wood-like decorative foil DRE-Cell Decor , 3D foil, CPL laminate or painted\*\*. Its construction allows to be used with door leaf with the thickness of 40 mm and its design allows for use on walls ranging between 75-320. There is possibility to choose the beam joining angle of 90° with the T80 architrave in decors white matt, black 2 matt, UV acrylic painted white, white pine, sand oak, 3D Polish oak, lacquered white, lacquered black, decors from the LUX and WOOD collections.

\*\*NOTE: To ensure the highest quality of painted and lacquered door frames, before varnishing or painting process they are coated with special material which constitutes solid base.

## APPLICATION

The adjustable non-rebated door frame with Estetic 80 hinges is applicable to all DRE collections in the non-rebated version with Estetic 80 hinges. The non-rebated adjustable door frame with plate hinges is suitable for the Sigma collection in matt black 2, lam\_white, lam\_white craft oak veneers.

## THE SET CONTAINS

Main beam (horizontal element and two vertical elements) with a wide architrave (80 mm) with small rounding radii of the cross-section profile (R2), door seal, set of hinges, set of elements intended for assembling the door frame according to the attached instructions. Door frames are packed in cardboard boxes.



Prices include 2 hinges with assembly plates.

- » Price of the door frame for double-leaf doors: +50% ( with 3 Estetic 80 hinges,extra charge )
- » Extra charge for the third Estetic 80 hinge
- » Price of the door frame for double-leaf doors: +50% ( with 3 plate hinges, extra charge )
- » Extra charge for the third plate hinge
- » Extra charge for connection of main beams at 90° available in white matt, black matt 2, white UV varnish, white pine, sand oak, Polish oak 3D, white varnish, black varnish and LUX and WOOD collection sdecors
- » Extra charge for reinforcement for self closer applies to door frames with 45° connection angle about

# NON-REBATED ADJUSTABLE DOOR FRAMES

NON-REBATED WITH T80 OR T63 ARCHITRAVE

ORB cross-section 095-300

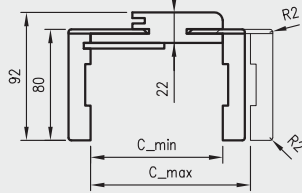

ORB cross-section 075

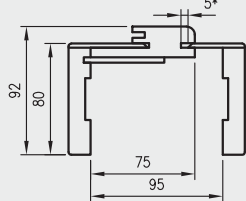

Vertical section of the door non-rebated door leaf

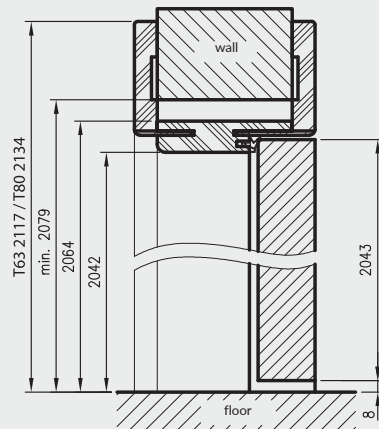

required wall passage height 2079 mm

ORB connection at 45°

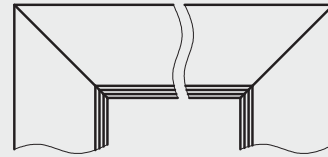

Adjustable non-rebated door frame connection at an angle of 90°\*\* T80 architrave

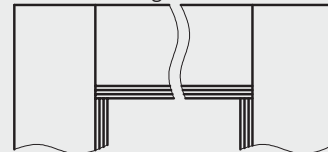

\*\* connection at 90° is available in white matt, black matt 2, white acrylic UV varnish, white pine, sand oak, Polish oak 3D, white varnish, black varnish and LUX and WOOD collections

ORB horizontal cross-section

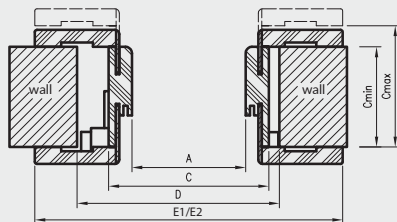

D - required width of wall opening

E1 - dimension for T63 architrave

E2 - dimension for T80 architrave

\*075-095 door frame has a different cross section, for 75-89 mm wall thickness, it is necessary to shorten the tongue of the adjustable architrave.

for double-leaf doors

	A	C	D	E1	E2
120	1274	1318	1350	1424	1458
130	1374	1418	1450	1524	1558
140	1474	1518	1550	1624	1658
150	1574	1618	1650	1724	1758
160	1674	1718	1750	1824	1858
170	1774	1818	1850	1924	1958
180	1874	1918	1950	2024	2058

for single-leaf doors

	A	C	D	E1	E2
60	627	671	700	777	811
70	727	771	800	877	911
80	827	871	900	977	1011
90	927	971	1000	1077	1111
100	1027	1071	1100	1177	1211

Prices include 2 hinges with assembly plates.

» Price of the door frame for double-leaf doors: +50% ( with 3 Estetic 80 hinges,extra charge )

» Extra charge for the third Estetic 80 hinge

» Price of the door frame for double-leaf doors: +50% ( with 3 plate hinges, extra charge )

» Extra charge for the third plate hinge

» Extra charge for connection of main beams at 90° available in white matt, black matt 2, white UV varnish, white pine, sand oak, Polish oak 3D, white varnish, black varnish and LUX and WOOD collections decors

» Extra charge for reinforcement for self closer applies to door frames with 45° connection angle about

2nd group CPL - CPL laminate natural halifax oak.

# ADJUSTABLE DOOR FRAMES

REBATED WITH VARIABLE HEIGHTS WITH T80 ANGLE BAR

By the fact of the interest expressed by our clients in doors of custom sizes, we have introduced to our offer collections of MODERN, PLUS and STANDARD 10 door leaf model with adjustable door frame equipped with angular architrave T80 in 3 additional heights.

## APPLICATION

Adjustable door frame with variable heights with T80 architrave can be used for rebated door leaf STANDARD 10, MODERN and PLUS collections with three additional leaf height options: 1983mm, 2110mm and 2240mm.

## SET CONTAINS

Main beam (one horizontal and two vertical elements together with masking elements), door seal, set of hinges, all necessary components for the installation of door frames in accordance with the supplied instruction. Door frames are packed in cardboard boxes. Door frames are packed in cardboard boxes.

All rebated door frames in 3 additional height options should be equipped with 3 hinges.



Cross-section of rebated door frame OR with the architrave, T80

OR vertical cross-section

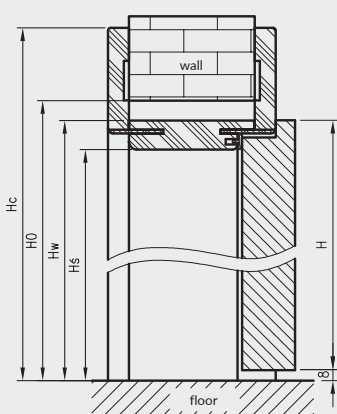

for single-leaf doors

	A	C	D	E
60	602	646	680	786
70	702	746	780	886
80	802	846	880	986
90	902	946	980	1086
100	1002	1046	1080	1186

for double-leaf doors

	A	C	D	E
120	1235	1279	1315	1419
130	1335	1379	1415	1519
140	1435	1479	1515	1619
150	1535	1579	1615	1719
160	1635	1679	1715	1819
170	1735	1779	1815	1919
180	1835	1879	1915	2019
190	1935	1979	2015	2119
200	2035	2079	2115	2219

H	H <sub>S</sub>	hw	H <sub>0</sub>	H <sub>C</sub>
1983	1969	1991	2006	2061
2110	2096	2118	2133	2188
2240	2226	2248	2263	2318

Black ST decor available only with T80 architrave

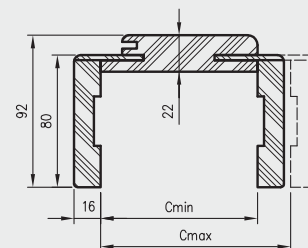

OR horizontal cross-section

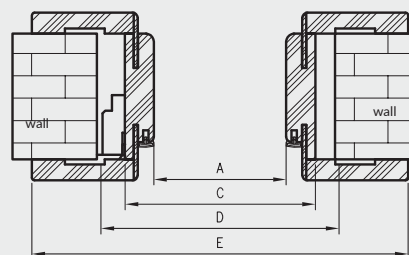

D - required width of wall opening  
H - door leaf height  
H<sub>0</sub> - required the wall passage height

Extra charge for reinforcement for self closer applies to door frames with 45° connection angle about

# NON-REBATED ADJUSTABLE DOOR FRAMES

NON-REBATED WITH VARIABLE HEIGHTS WITH T80 ARCHITRAVE

Due to customers' interest in non-rebated doors in non-standard dimensions, we have introduced the Modern and Plus collections and the Standard 10 door leaf model with an adjustable non-rebated door frame in 3 additional height variants. The structure of the door frame is the same as the non-rebated adjustable door frame (the only difference is the height).

## APPLICATION

Non-rebated adjustable door frame with variable heights can be used with non-rebated STANDARD 10, MODERN and PLUS door leaf model which are available in three additional door leaf height options: 1983 mm, 2110 mm and 2240 mm.

## SET CONTAINS

Main beam (one horizontal and two vertical elements together with masking elements), door seal, set of hinges, all necessary components for the installation of door frames in accordance with the supplied instruction. Door frames are packed in cardboard boxes.

All door frames in 3 additional height options can be equipped with 2 or 3 hinges.



H	H <sub>S</sub>	hw	H <sub>0</sub>	HC
1983	1982	2004	2019	2074
2110	2109	2131	2146	2201
2240	2239	2261	2276	2331

ORB cross-section 095-300

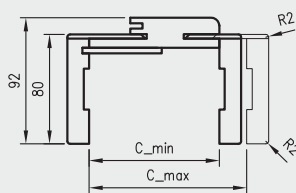

ORB cross-section 075

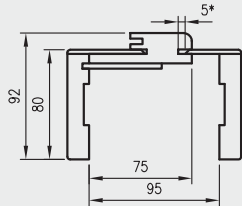

ORB vertical cross-section

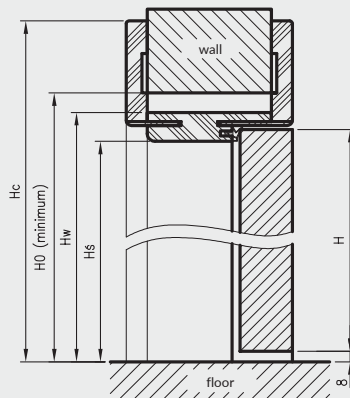

H<sub>0</sub> - required the wall passage height

ORB horizontal cross-section

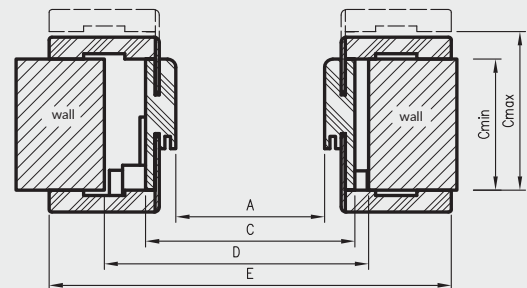

for double-leaf doors

	A	C	D	E
120	1274	1318	1350	1458
130	1374	1418	1450	1558
140	1474	1518	1550	1658
150	1574	1618	1650	1758
160	1674	1718	1750	1858
170	1774	1818	1850	1958
180	1874	1918	1950	2058

\*NOTE: 075-095 door frame has a different cross-section, for a 75-89 mm wall thickness, it will be necessary to shorten pen of the adjustable angle element.

D - required width of wall opening

for single-leaf doors

	A	C	D	E
60	627	671	700	811
70	727	771	800	911
80	827	871	900	1011
90	927	971	1000	1111
100	1027	1071	1100	1211

Black ST decor available only with T80 architrave

Prices include 2 hinges with assembly plates.

Price of the double-leaf door frame: + 50% (if 3 hinges are used, there is extra charge )

» Additional payment for the third hinge Estetic 80

» Extra charge for reinforcement for self closer applies to door frames with 45° connection angle about

# NON-REBATED ADJUSTABLE DOOR FRAMES

FOR DOOR LEAVES WITH INVERTED REBATE

## CONSTRUCTION

The adjustable door frame with inverted rebate is made of high-quality wood-based board. On the display side, it is covered with ecological, wood-like decorative foil DRE Cell, CP black ST or painted with the highest quality acrylic UV varnishes. To ensure high quality of painted door frames, before painting, they are covered with a special material constituting a uniform base. Its design is adapted to a door leaf thickness of 40 mm and allows for use on walls with a thickness of 90 - 290 mm. Joining at an angle of 45°.

## APPLICATION

The door frame with inverted rebate is suitable for selected collections: Estra, Nestor, Nova Cell Uni, Binito, Fargo.

## THE SET CONTAINS

Main beam (horizontal element and two vertical elements), T80 architrave (horizontal and two vertical elements), door seal, set of two Estetic 1821 hinges, magnetic lock latch strike plate, set of elements for assembling the door frame according to the attached instructions. Door frames are packed in cardboard boxes.



vertical cross-section of ORO

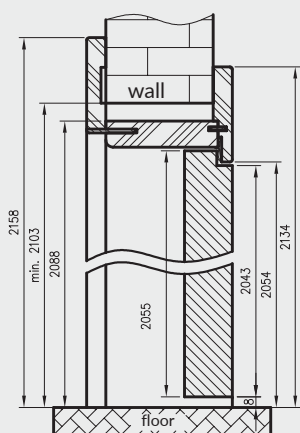

door frame profile

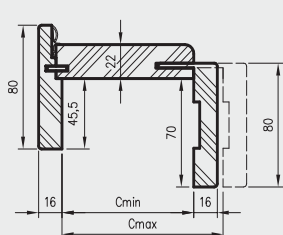

left door leaf

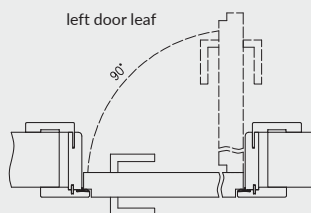

right door leaf

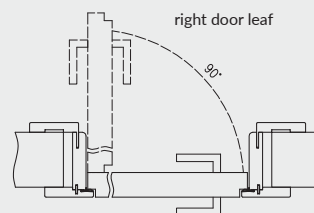

horizontal cross-section of ORO

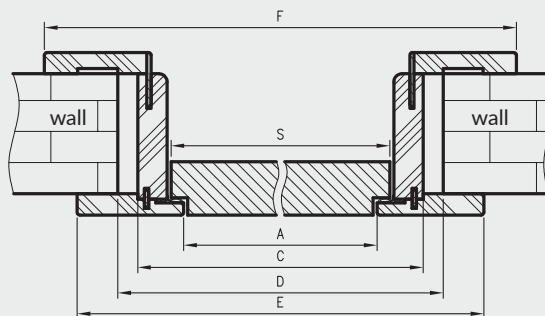

Estetic 1821 hinge

### DRE-Cell Decor

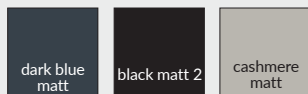

### CPL decor



### Painted decor



white acrylic UV varnish - RAL 9003  
 ecru - RAL 9001  
 latte - Flugger 4362, NCS S1505-Y50R  
 ashen - RAL 7035

Required height of the wall opening = 2103 mm  
 D - required width of wall passage

	A	C	D	E	F	S
60	625	694	724	785	834	644
70	725	794	824	885	934	744
80	825	894	924	985	1034	844
90	925	994	1024	1085	1134	944
100	1025	1094	1124	1185	1234	1044



# ADJUSTABLE TUNNEL

WITH ARCHITRAVE T63, T80

An adjustable tunnel is a decorative element of a wall passage. It can be used as a stand-alone solution or as an integral part of the NT wall sliding system.

The adjustable tunnel is a product which is, at first glance visually similar to adjustable door frames, but with a few differences:

- » there is no possibility to mount any hinges
- » there is no latch strike plate
- » there is no channel for a gasket different heights and spans of the front and rear architraves (values E and F in tables)

TUN tunnel cross-section with the architrave. T80

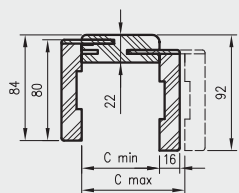

TUN tunnel cross-section with the architrave. T63

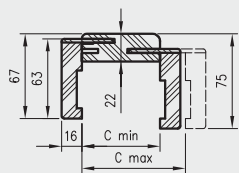

NOTE: To ensure the highest quality of painted tunnels, before painting process they are coated with special material which constitutes solid base.

Vertical cross-section of an adjustable tunnel with architrave. T80

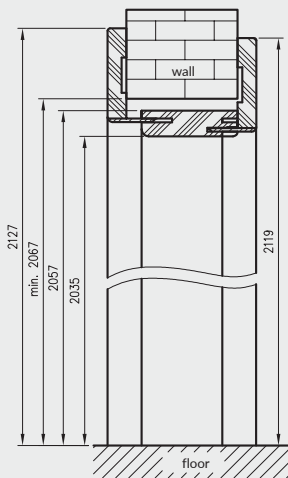

required height of wall opening 2067 mm

Vertical cross-section of an adjustable tunnel with architrave. T63

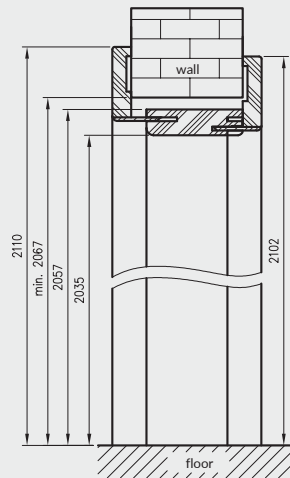

## Single adjustable tunnel

symbol	60	70	80	90	100
A	602	702	802	902	1002
C	646	746	846	946	1046
D	664	764	864	964	1064
E*	752	852	952	1052	1152
E**	786	886	986	1086	1186
F*	736	836	936	1036	1136
F**	770	870	970	1070	1170

D - required width of wall opening  
\* applies to the Adjustable Tunnel with architrave. T63  
\*\* applies to the Adjustable Tunnel with an architrave. T80

OPTIONS AVAILABLE WITH EXTRA CHARGE

Tunnel for double leaf door: +30%

## Adjustable tunnel cross section

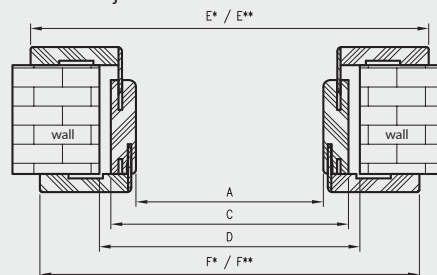

Black ST decor available only with T80 architrave

## Double adjustable tunnel

symbol	120	130	140	150	160	170	180	190	200	symbol	120	130	140	150	160	170	180	190	200
A	1200	1300	1400	1500	1600	1700	1800	1900	2000	E**	1384	1484	1584	1684	1784	1884	1984	2084	2184
C	1244	1344	1444	1544	1644	1744	1844	1944	2044	F*	1334	1434	1534	1634	1734	1834	1934	2034	2134
D	1264	1364	1464	1564	1664	1764	1864	1964	2064	F**	1368	1468	1568	1668	1768	1868	1968	2068	2168
E*	1350	1450	1550	1650	1750	1850	1950	2050	2150	2nd group CPL - CPL laminate natural halifax oak.									



UNI 10 - white

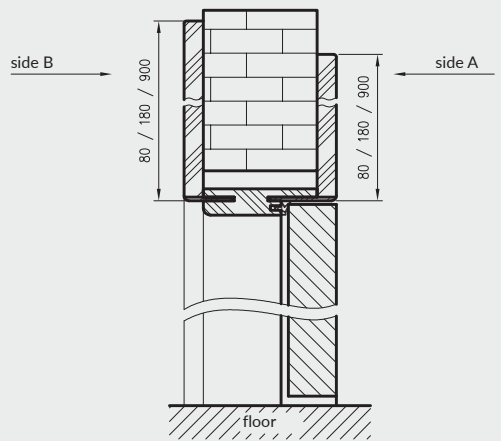

size of the architrave panels	side A	side B
80 mm(x2)	80	80
180 mm(x2)	180	180
900 mm(x2)	900	900
80/180 mm (1/1)	80	180
180/80 mm (1/1)	180	80
80/900 mm (1/1)	80	900
900/80 mm (1/1)	900	80
180/900 mm (1/1)	180	900
900/180 mm (1/1)	900	180



white acrylic UV varnish - RAL 9003  
 ecru - RAL 9001  
 latte - Flugger 4362, NCS S1505-Y50R  
 ashen - RAL 7035

Price of the set = price of two vertical beams + price of the horizontal beam with architrave panels

# NON-REBATED ADJUSTABLE DOOR FRAMES WITH ARCHITRAVE PANELS

WITH ARCHITRAVE PANELS

## CONSTRUCTION

The non-rebated adjustable door frame is made of high-quality wood-based board. The display side is entirely covered with a special foil and then painted. Its construction allows to be used with door leaf with the thickness of 40 mm and its design allows for use on walls ranging between 75-320. There are special angle panels in the lintel on both sides of the door frame, with the following dimensions: 80 mm, 180 mm or 900 mm.

## APPLICATION

Adjustable non-rebated door frame with architrave panels can be used with all DRE non-rebated painted collections.

## SET CONTAINS

Vertical beams with wide architrave (80 mm) with small rounding radii of the cross-section profile (R2), upper beam with angle panels to choose from, door seal, set of hinges, set of elements for assembling the door frame according to the attached instructions. Door frames are packed in cardboard boxes.

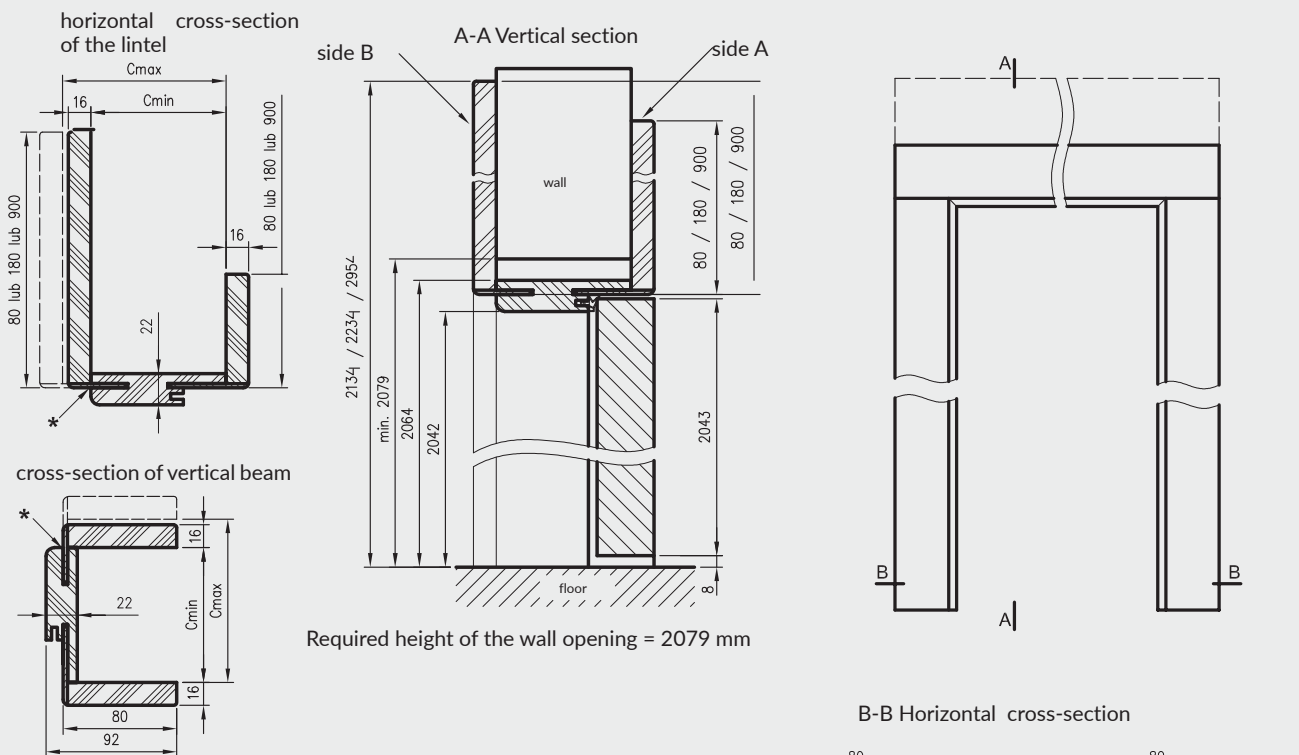

\*NOTE: 075-095 door frame has a different cross-section, shallow milling for architrave, for a 75-89 mm wall thickness, it will be necessary to shorten the tongue of the adjustable masking architrave.

\*\* - third hinge, option at extra charge

for single-leaf doors

	A	C	D	E
60	627	671	700	811
70	727	771	800	911
80	827	871	900	1011
90	927	971	1000	1111
100	1027	1071	1100	1211

# EXTENSION PANELS

## APPLICATION

The extension panel is a component of the decorative passage in the wall or the increased possibility of installing door frames on walls thicker than 320 mm. The panel is an extension of the central parts of the adjustable door frames and adjustable tunnels. It can be used with the adjustable architraves from previously ordered door frames or tunnels with a connection angle of 45°.

Extension panels with variable heights are available only in Cell and CPL group.

## SET CONTAINS

- » two vertical beams
- » horizontal beam
- » three connecting tongues
- » accessories used to connect main beams

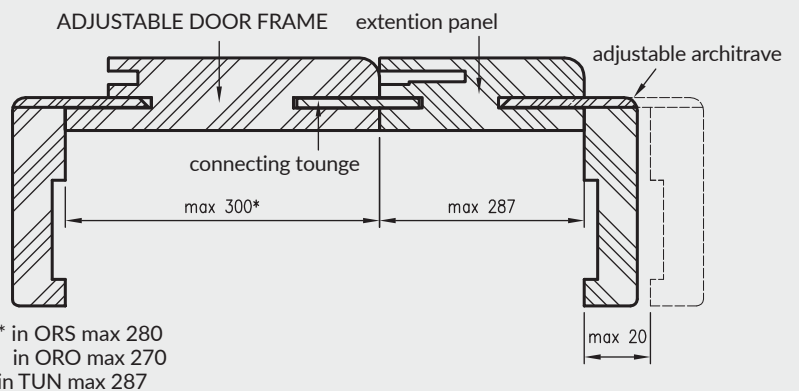
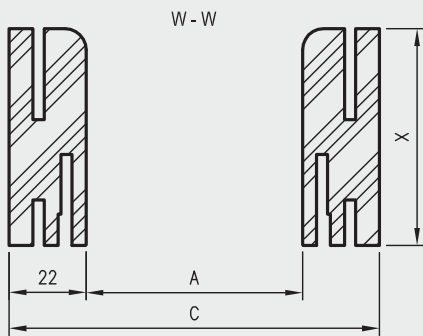
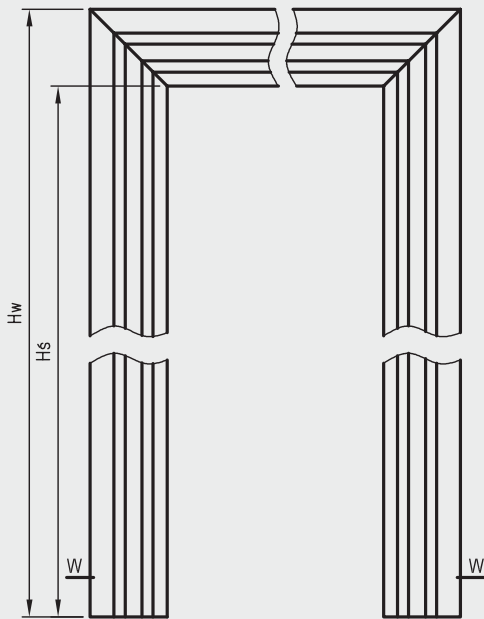

options of the width of panels cross-section

X	062	082	107	127	147	167	187	207	227	247	267	287
---	-----	-----	-----	-----	-----	-----	-----	-----	-----	-----	-----	-----

# EXTENSION PANELS

## Dimensions of extension panels OR - adjustable door frames for rebated doors

height options					for single-leaf doors						for double-leaf doors											
	PL	198x	211x	224X	"60"	"70"	"80"	"90"	"100"	"110"	„100d"	„110d"	„120"	„130"	„140"	„150"	„160"	„170"	„180"	„190"	„200"	
HŚ	2029	1969	2096	2226	A	602	702	802	902	1002	1102	1035	1135	1235	1335	1435	1535	1635	1735	1835	1935	2035
hw	2051	1991	2118	2248	C	646	746	846	946	1046	1146	1079	1179	1279	1379	1479	1579	1679	1779	1879	1979	2079

## Dimensions of the ORB extension panels connected at 45 ° - non-rebated adjustable door frames for non-rebated doors connected at 45 °

height options					for single-leaf doors						for double-leaf doors						
	PL	198x	211x	224X	"60"	"70"	"80"	"90"	"100"	„120"	„130"	„140"	„150"	„160"	„170"	„180"	
HŚ	2042	1982	2109	2239	A	627	727	827	927	1027	1274	1374	1474	1574	1674	1774	1874
hw	2064	2004	2131	2261	C	671	771	871	971	1071	1318	1418	1518	1618	1718	1818	1918

## Dimensions of TUN extension panels - adjustable tunnels

		for single-leaf doors					for double-leaf doors									
	PL	"60"	"70"	"80"	"90"	"100"	„120"	„130"	„140"	„150"	„160"	„170"	„180"	„190"	„200"	
HŚ	2035	A	602	702	802	902	1002	1200	1300	1400	1500	1600	1700	1800	1900	2000
hw	2057	C	646	746	846	946	1046	1244	1344	1444	1544	1644	1744	1844	1944	2044

## Dimensions of the ORC extension panels - adjustable door frames for glass doors

	PL	"60"	"70"	"80"	"90"	
HŚ	2035	A	600	700	800	900
hw	2057	C	644	744	844	944

## Dimensions of the ORS extension panels - adjustable door frames for folding doors

	PL	"80"	"90"	"100"	
HŚ	2029	A	806	906	1006
hw	2051	C	850	950	1050

## Dimensions of ORO extension panels - adjustable door frames for door leaves with inverted rebate

	PL	"60"	"70"	"80"	"90"	"100"	
HŚ	2066	A	650	750	850	950	1050
hw	2088	C	694	794	894	994	1094

### OPTIONS AVAILABLE WITH EXTRA CHARGE

panel for double doors: + 30%

# STEEL FIXED DOOR FRAMES

## CONSTRUCTION

Steel door frames are made of 1.5 mm thick low-carbon steel sheet, protected with a protective organic varnish coating. The door frame consists of two beams: a catch beam and a hinge beam (in the case of double-leaf door frames there only two hinge beams ) and the upper beam , permanently connected to each other by welding. Hinge beams are equipped with hinge sockets, while catch beams have cutouts for the tongue and latches for the lock of a dedicated door leaf (the set includes a cover seal). The profile of the door frame, its dimensions, equipment and colors depend on the selected variant - the type of door for which the door frame is to be used.

## APPLICATION / TYPES OF OSS DOOR FRAMES (FIXED STEEL DOOR FRAMES)

OSS_STAND	OSS For rebated interior doors
OSSB_STAND	OSS for non-rebated interior doors
OSS_GLASS	OSS for interior glass doors
OSS_ENTER	OSS for the Enter door, Enter Akustik, Revos
OSS_SOLID	OSS for solid doors
OSS_SOLID_RC2	OSS for Solid RC2 door leaf
OSS_ATHOS	OSS for Athos door leaf
OSS_FORCA	OSS for Forca or Forca B door leaf
OSS_OLIMP_EI30	OSS for Olimp EI-30 door leaf

All frames are designed to be mounted on the finished floor.

### STANDARD OPTIONS IN OSS

- » sockets for 2, 3, 4 or 6 hinges
- » socket for latch plate of main lock

### STANDARD OPTIONS IN OSSB

- » sockets for 2 or 4 hinges
- » magnetic lock latch

### STANDARD OPTIONS IN OSS GLASS

- » sockets for 2 hinges
- » socket for latch plate of main lock

### STANDARD OPTIONS IN OSS ENTER

- » sockets for 3 hinges
- » socket for main lock or additionally for upper lock

### STANDARD OPTIONS IN OSS SOLID

- » sockets for 3 hinges
- » additional sockets for anti-thrust bolts
- » sockets for latch bolts of multi-point lock used in SOLID model

### STANDARD OPTIONS IN OSS SOLID RC2

- » sockets for 3 triple hinges
- » additional sockets for anti-thrust bolts
- » sockets for latch bolts of multi-point lock used in SOLID model

### STANDARD OPTIONS IN OSS ATHOS, FORCA, FORCA B

- » sockets for 3 triple hinges
- » additional sockets for anti-thrust bolts
- » sockets for latch plates of five point mortise lock (FORCA, FORCA B)
- » socket for latch plate of main lock (ATHOS)

### STANDARD OPTIONS FOR OSS OLIMP EI30

- » socket for latch plate of main lock
- » sockets for 3 or 6 triple hinges (6 for double-leaf frames)

## AVAILABLE COLOURS

Door frame is powder coated in two gloss scale (matt / low structure or semi-gloss / plain). There are available colours:

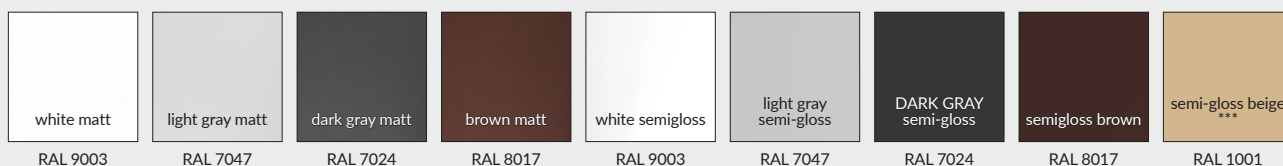

\*\*\* beige colour is available only in semi-gloss



# STEEL FIXED DOOR FRAMES

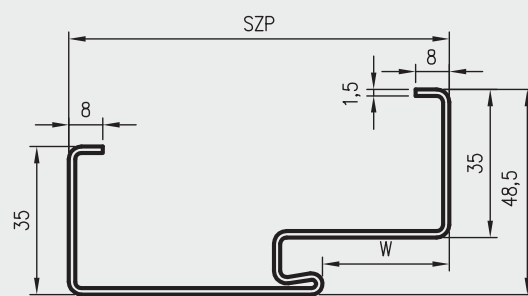
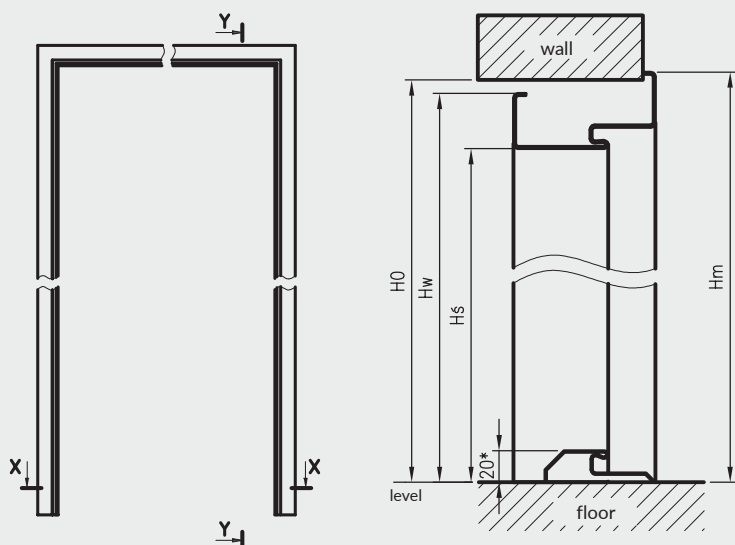

type of the door frame	H0	H <sub>s</sub>	hw	hm	W	SZP
OSSB STAND	2084	2040,5	2075,5	2089	46	106
OSS STAND	2071	2027,5*	2062,5	2076	30	90
OSS ENTER						
OSS SOLID						
OSS SOLID RC2						
OSS FOR GLASS DOORS	2077	2033,5	2068,5	2082	30	90
OSS ATHOS	2073	2029,5*	2064,5	2078	38	117
OSS FORCA						
OSS OLIMP EI30	2070	2025,5	2060,5	2074		

H0 - height of the wall opening

H<sub>s</sub> - height of the door frame passage

\* - with the use of a steel threshold - the actual height of the door frame passage will be reduced by 20mm from the floor

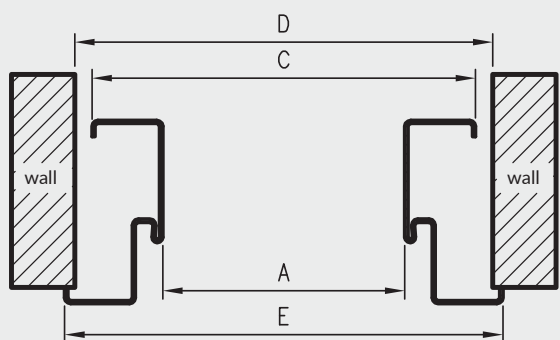

D - width of the assembly hole

OSS width dimensions

symbol width.	A	C	D	E	OSS STAND	OSS glass doors	OSS ENTER	OSS SOLID	OSS SOLID RC2	OSS ATHOS	OSS FORCA
"60"	600	670	687	697	●	●					
"70"	700	770	787	797	●	●	●				
"80"	800	870	887	897	●	●	●	●	●	●	●
"90"	900	970	987	997	●	●	●	●	●	●	●
"90E"	904	974	991	1001	●		●	●	●		●
"90E"	915	985	1002	1012						●	●
"100"	1000	1070	1087	1097	●		●	●	●	●	●
"110"	1100	1170	1187	1197	●		●			●	

\*\*\*\* - investment dimension "90E" different for technical and remaining doors

OSS OLIMP EI30 for single leaf door

symbol width.	A	C	D	E
"80"	802	872	889	899
"90"	902	972	989	999
"90E"	917	987	1004	1014
"100"	1002	1072	1089	1099
"110"	1102	1172	1189	1199

OSS OLIMP EI30 for double leaf doors

symbol width.	A	C	D	E
"160"	1637	1707	1724	1734
"170"	1737	1807	1824	1834
"180"	1837	1907	1924	1934
"190"	1937	2007	2024	2034
"200"	2037	2107	2124	2134
"210"	2137	2207	2224	2234
"220"	2237	2307	2324	2334

OSS STAND dimensions for double leaf doors

symbol width.	A	C	D	E
"100d"	1032	1102	1119	1129
"110d"	1132	1202	1219	1229
"120"	1232	1302	1319	1329
"130"	1332	1402	1419	1429
"140"	1432	1502	1519	1529
"150"	1532	1602	1619	1629
"160"	1632	1702	1719	1729
"170"	1732	1802	1819	1829
"180"	1832	1902	1919	1929
"190"	1932	2002	2019	2029
"200"	2032	2102	2119	2129

OSSB STAND for single leaf door

symbol width.	A	C	D	E
"60"	624	694	711	721
"70"	724	794	811	821
"80"	824	894	911	921
"90"	924	994	1011	1021
"100"	1024	1094	1111	1121

OSSB STAND for double leaf doors

symbol width.	A	C	D	E
"120"	1271	1341	1358	1368
"130"	1371	1441	1458	1468
"140"	1471	1541	1558	1568
"150"	1571	1641	1658	1668
"160"	1671	1741	1758	1768
"170"	1771	1841	1858	1868
"180"	1871	1941	1958	1968

\* - STAND steel fixed door frames for double leaf door "100d" - "200" width

\*\* - OSS FORCA B - OSS FORCA option for Forca B doors (without fire resistance)

\*\*\* - steel fixed non-rebated OSSB STAND single-leaf door frames with 3 hinges, extra charge, for double-leaf doors with 6 hinges, extra charge of

# ADJUSTABLE METAL DOOR FRAME

The essence of an adjustable door frame is that it allows the final closure of the wall opening without the need to finish the wall. The extension of the door frames closing architrave, allows for adjustment in the range of +30mm



## APPLICATION / TYPES OF OSR (ADJUSTABLE STEEL DOOR FRAMES)

OSR_STAND	OSR For rebated interior doors
OSRB_STAND	OSR for non-rebated interior doors
OSR_GLASS	OSR For interior glass doors
OSR_ENTER	OSR for the door leaf Enter, Enter Akustik, Revos
OSR_SOLID	OSS for solid doors
OSR_SOLID_RC2	OSR for Solid RC2
OSR_ATHOS	OSR for Athos door leaf
OSR_FORCA	OSR for Forca or Forca B door leaf
OSR_OLIMP EI 30	OSS for Olimp EI-30 door leaf
OSR_OLIMP EI 60	OSR for Olimp EI 60 doors

All frames are designed to be mounted on the finished floor.

The door frames are suitable for walls with a thickness of 95-305 mm, 103-313 mm in the case of steel adjustable door frames OSR FORCA, steel adjustable door frames OSR ATHOS and steel adjustable door frames OSR OLIMP EI30 or 113-323 mm in the case of steel adjustable door frames OSR OLIMP EI 60. For a given wall thickness, select the appropriate door frame variant, the range of which Cmin - Cmax will include the thickness of the finished wall.

## CONSTRUCTION

Steel door frames are made of 1.5 mm thick low-carbon steel sheet, powder-coated. The door frame consists of two beams: a catch beam and a hinge beam (in the case of double-leaf door frames there only two hinge beams ) and the upper beam , permanently connected to each other by welding. Hinge beams are equipped with hinge sockets, while catch beams have cutouts for the tongue and latches for the lock of a dedicated door leaf (the set includes a cover seal). The outer and inner sides of the door frame are protected with a protective, organic varnish coating. The profile of the door frame, its dimensions and equipment depend on the selected variant - the type of door for which the door frame is to be used.

## STANDARD OPTIONS IN OSR STAND

- » sockets for 2, 3, 4 or 6 hinges
- » socket for latch plate of main lock

## STANDARD OPTIONS IN OSRB STAND

- » sockets for 2 or 4 hinges
- » magnetic lock latch

## STANDARD OPTIONS IN OSR GLASS DOORS

- » sockets for 2 hinges
- » socket for latch plate of main lock

## STANDARD OPTIONS IN OSR ENTER

- » sockets for 3 hinges
- » socket for main lock or additionally for upper lock

## STANDARD OPTIONS IN OSR SOLID

- » sockets for 3 hinges
- » additional sockets for anti-thrust bolts
- » sockets for latch bolts of multi-point lock used in SOLID model

## STANDARD OPTIONS IN OSR SOLID RC2

- » sockets for 3 triple hinges
- » additional sockets for anti-thrust bolts
- » sockets for latch bolts of multi-point lock used in SOLID model

## STANDARD OPTIONS IN OSR ATHOS, FORCA, FORCA B

- » sockets for 3 triple hinges
- » additional sockets for anti-thrust bolts
- » sockets for latch plates of five point mortise lock (FORCA, FORCA B)
- » socket for latch plate of main lock (ATHOS)

## STANDARD OPTIONS FOR OSR OLIMP EI30

- » sockets for 3 threefold hinges
- » socket for latch plate of main lock

## AS STANDARD STEEL ADJUSTABLE DOOR FRAME OSR OLIMP EI 60

- » sockets for 3 pcs. of three-part or object hinges
- » socket for latch plate of main lock

## AVAILABLE COLOURS

Door frame is powder coated in two gloss scale (matt / low structure or semi-gloss / plain). There are available colours:



\*\*\* beige colour is available only in semi-gloss



# ADJUSTABLE METAL DOOR FRAME

REBATED

## Adjustable steel rebated door frames - dimensions

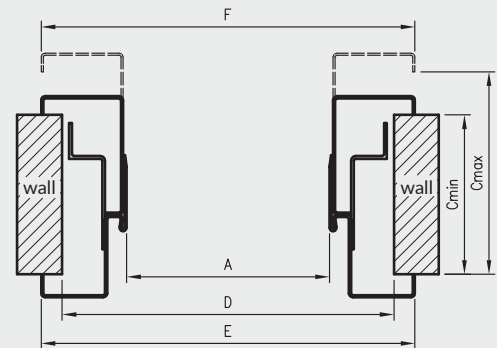
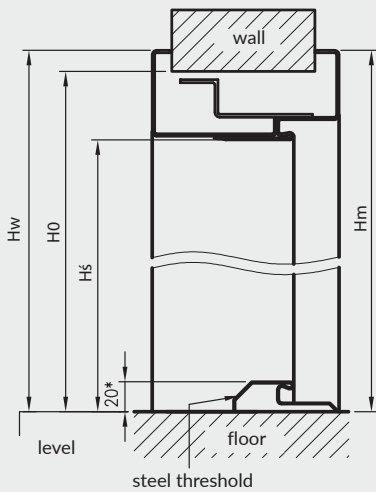

\* - with the use of a steel threshold - the actual height of the door frame passage will be reduced by 20mm from the floor

D - width of the wall opening

### OSR door frame profile with the T57 architrave

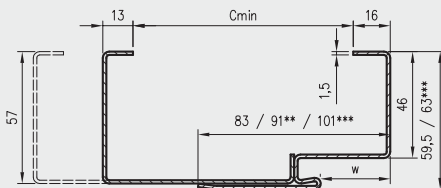

\*\* 91 for steel adjustable door frame OSR ATHOS, OSR FORCA, OSR FORCA B and OSR OLIMP EI 30  
\*\*\* applies to steel adjustable door frame OSR Olimp EI 60

### OSR OLIMP EI30 for single leaf door

symbol width.	A	D	E	F
"80"	802	892	921	921
"90"	902	992	1021	1021
"90E"	917	1007	1036	1036
"100"	1002	1092	1121	1121
"110"	1102	1192	1221	1221

### steel adjustable door frame OSR OLIMP EI60 for single leaf door

symbol width.	A	D	E	F
"80"	797	894	923	916
"90"	897	994	1023	1016
"90E"	926	1023	1052	1045
"100"	997	1094	1123	1116
"110"	1097	1194	1223	1216

### OSR width dimensions

symbol width.	A	D	E	OSR_STAND	OSR_GLASS DOORS	OSR_ENTER	OSR_SOLID	OSR_SOLID_RC2	OSR_ATHOS	OSR_FORCA
"60"	600	690	719	•	•					
"70"	700	790	819	•	•	•				
"80"	800	890	919	•	•	•	•	•	•	•
"90"	900	990	1019	•	•	•	•	•	•	•
"90E"	904	994	1023	•		•	•	•		
"90E"	915	1005	1034						•	•
"100"	1000	1090	1119	•		•	•	•	•	•
"110"	1100	1190	1219	•		•			•	

\*\*\*\* - investment dimension "90E" different for technical and remaining doors

### OSR STAND dimensions for double leaf doors

symbol width.	A	D	E	F
"100D"	1032	1122	1151	1151
"110D"	1132	1222	1251	1251
"120"	1232	1322	1351	1351
"130"	1332	1422	1451	1451
"140"	1432	1522	1551	1551
"150"	1532	1622	1651	1651
"160"	1632	1722	1751	1751
"170"	1732	1822	1851	1851
"180"	1832	1922	1951	1951
"190"	1932	2022	2051	2051
"200"	2032	2122	2151	2151

type of the door frame	H0	Hs	hw	hm	W
OSR_STAND					
OSR_ENTER	2073	2027,5*	2088	2087	30
OSR_SOLID					
OSR_SOLID_RC2					
OSR_GLASS DOORS	2079	2033,5	2094	2093	30
OSR_ATHOS	2073	2027,5*	2088	2087	38
OSR_FORCA					
OSR OLIMP EI30	2073	2027,5	2088	2087	
steel adjustable door frame OSR OLIMP EI60	2072	2023	2083,5	2086	48

H0 - height of the wall opening

Hs - height of the door frame passage

\* - with the use of a steel threshold - the actual height of the door frame passage will be reduced by 20mm from the floor

# ADJUSTABLE METAL DOOR FRAME



# ADJUSTABLE METAL DOOR FRAMES

NON-REBATED

## Adjustable steel non-rebated door frames - dimensions

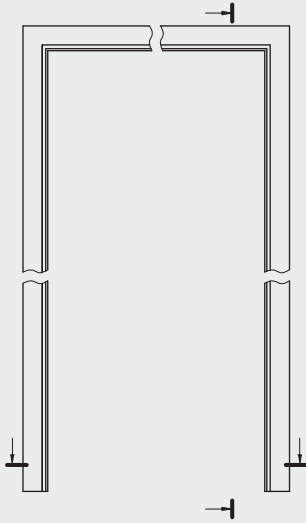

Vertical section of the OSRB

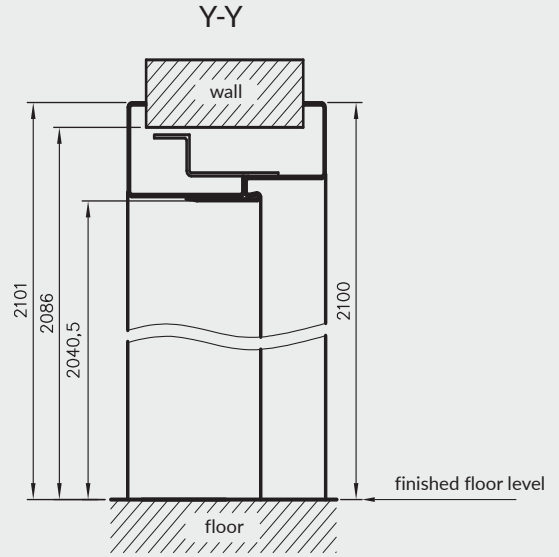

OSRB horizontal cross-section

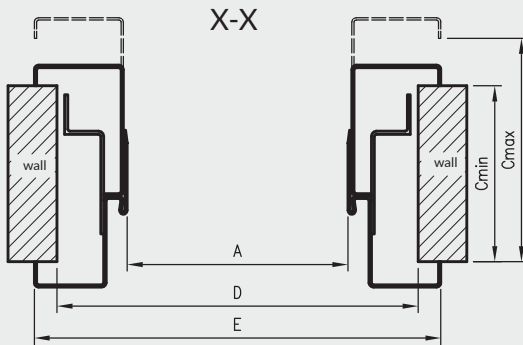

D - width of the assembly hole

adjustable steel non-rebated door frame profile

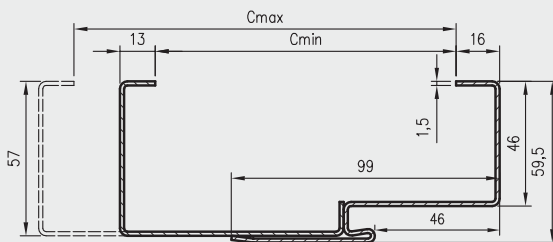

Dimensions for single leaf doors

symbol width.	A	D	E
"60"	624	714	743
"70"	724	814	843
"80"	824	914	943
"90"	924	1014	1043
"100"	1024	1114	1143

Dimensions for double leaf doors

symbol width.	A	D	E
„120"	1271	1361	1390
„130"	1371	1461	1490
„140"	1471	1561	1590
„150"	1571	1661	1690
„160"	1671	1761	1790
„170"	1771	1861	1890
„180"	1871	1961	1990

Note: Extra charge for reinforcement for the door self closer ,

\*\*\* - steel adjustable non-rebated OSRB STAND single-leaf door frames with 3 hinges, extra charge ,  
for double-leaf doors with 6 hinges, extra charge of

# HYBRID STEEL DOOR FRAMES

## CONSTRUCTION:

Steel hybrid door frames are a solution combining the solidity of a metal structure with additional functionality allowing for full construction of the wall opening using wood-based door frame elements finished with CPL laminate. The hybrid door frame is a combination of a fixed-width metal door frame, a wood-based panel available in 11 width variants and a masking architrave. This solution allows for full construction of the wall opening with a thickness of 137-337 mm (145-345 for technical doors and 155-355 for Olimp EI60 doors) and adjustment with an architrave up to 20 mm.

Door frame profile dimensions and equipment depend on selected option - door leaf model.

## APPLICATION / TYPES OF OSH DOOR FRAMES (HYBRID STEEL DOOR FRAMES)

OSH_STAND	OSH for rebated interior door leaf
OSHB_STAND	OSH for non-rebated interior doors
OSH_GLASS	OSH For interior glass doors
OSH_ENTER	OSH for the door Enter, Enter Akustik, Revos
OSH_SOLID	OSH for Solid doors
OSH_SOLID_RC2	OSH for Solid RC2
OSH_ATHOS	OSH for the Athos door leaf
OSH_FORCA	OSH for Forca or Forca B door leaf
OSH_OLIMP EI 30	OSH for Olimp EI-30 door leaf
OSH_OLIMP EI 60	OSH for Olimp EI 60 doors

All frames are designed to be mounted on the finished floor.

### STANDARD OPTIONS IN OSH STAND

- » sockets for 2 or 3 hinges
- » socket for latch plate of main lock  
In the door frame for double leaf doors - sockets for 4 or 6 hinges

### STANDARD OPTIONS IN OSHB STAND

- » sockets for 2 or 4 hinges
- » magnetic lock latch

### STANDARD OPTIONS IN OSH GLASS

- » sockets for 2 hinges
- » socket for latch plate of main lock

### STANDARD OPTIONS IN OSH ENTER

- » sockets for 3 hinges
- » socket for main lock or additionally for upper lock

### STANDARD OPTIONS IN OSH SOLID

- » sockets for 3 hinges
- » additional sockets for anti-thrust bolts
- » sockets for latch bolts of multi-point lock used in SOLID model

### STANDARD OPTIONS IN OSH SOLID RC2

- » sockets for 3 triple hinges
- » additional sockets for anti-thrust bolts
- » sockets for latch bolts of multi-point lock used in SOLID model

### STANDARD OPTIONS IN OSH ATHOS, FORCA



- » sockets for 3 triple hinges
- » additional sockets for anti-thrust bolts
- » sockets for latch plates of five point mortise lock (FORCA, FORCA B)
- » socket for latch plate of main lock (ATHOS)

### STANDARD OPTIONS FOR OSH OLIMP EI30

- » socket for latch plate of main lock
- » sockets for 3 triple hinges

### AVAILABLE COLOURS



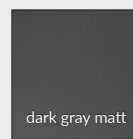
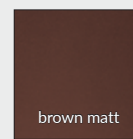
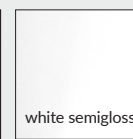
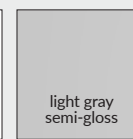
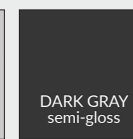
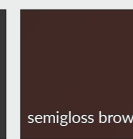
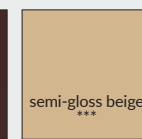

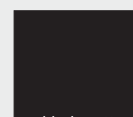
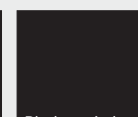
Door frame is powder coated in two gloss scale (matt / low structure or semi-gloss / plain). There are available colours:

 white matt RAL 9003	 light gray matt RAL 7047	 dark gray matt RAL 7024	 brown matt RAL 8017	 white semigloss RAL 9003	 light gray semi-gloss RAL 7047	 DARK GRAY semi-gloss RAL 7024	 semigloss brown RAL 8017	 semi-gloss beige*** RAL 1001
---	--	---	---	--	--	--	--	--

 black matt RAL 9005	 Black semi-gloss RAL 9005
---	---

\*\*\* beige colour is available only in semi-gloss

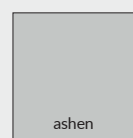
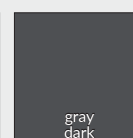
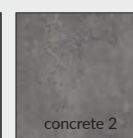
Adjustable panel with a masking architrave coated with CPL laminate from the list below:

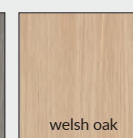
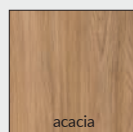
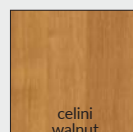
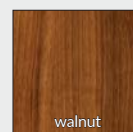
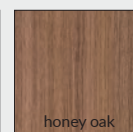
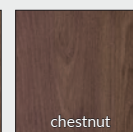
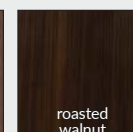
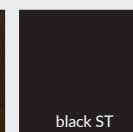
CPL Lami- nate	 white	 milky white	 ashen	 gray dark	 concrete 2	 gray oak	 welsh oak
	 acacia	 celini walnut	 walnut	 honey oak	 chestnut	 roasted walnut	 black ST



### AS A STANDARD STEEL HYBRID DOOR FRAME OSH OLIMP EI60

- » socket for latch plate of main lock
- » sockets for 3 pcs. of three-part or object hinges

# HYBRID STEEL DOOR FRAMES

REBATED

## Hybrid steel rebated door frames - dimensions

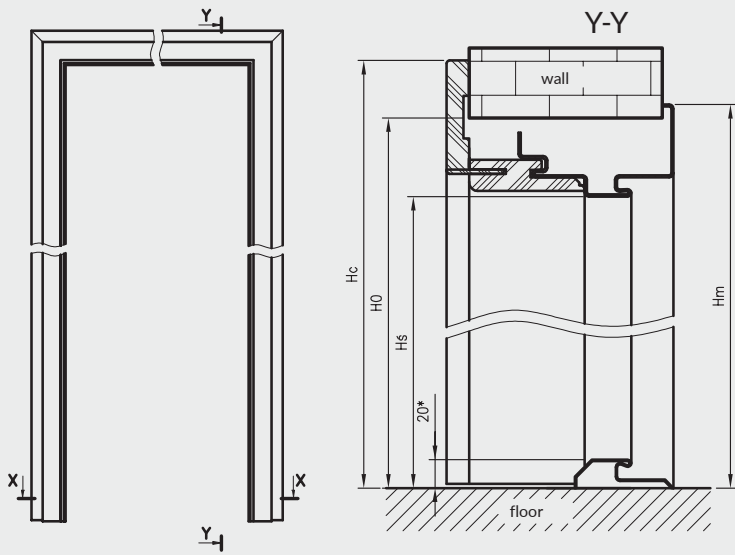

type of the door frame.	H0	Hs	hm	HC
OSH_STAND	2083	2027,5*	2092,5	2124
OSH_ENTER				
OSH_SOLID				
OSH_SOLID_RC2				
OSH glass doors	2089	2033,5	2098,5	2130
OSH_ATHOS	2085	2029,5*	2094,5	2126
OSH_FORCA				
OSH OLIMP EI30	2081	2025,5	2090	2122
OSH OLIMP EI60	2082	2023	2091,5	2119

H0 - height of the wall opening

Hs - height of the door frame passage

\* - when using a steel threshold - actual the height of the clear passage will decrease by 20mm from the given one

	OSH_STAND	OSH glass doors	OSH_ENTER	OSH_SOLID	OSH_SOLID_RC2	OSH_ATHOS	OSH_FORCA
symbol width.							
"60"	•	•					
"70"	•	•	•				
"80"	•	•	•	•	•	•	•
"90"	•	•	•	•	•	•	•
"90E"	•	•	•	•	•		
"90E"						•	•
"100"	•	•	•	•	•	•	•
"110"	•	•				•	

### Dimensions of the door frame width

symbol width.	A	D	E	F	OSH_STAND	OSH glass doors	OSH_ENTER	OSH_SOLID	OSH_SOLID_RC2	OSH_ATHOS	OSH_FORCA
"60"	600	710	730	792	•	•					
"70"	700	810	830	892	•	•	•				
"80"	800	910	930	992	•	•	•	•	•	•	•
"90"	900	1010	1030	1092	•	•	•	•	•	•	•
"90E"	904	1014	1034	1096	•	•	•	•			
"90E"	915	1025	1045	1107						•	•
"100"	1000	1110	1130	1192	•	•	•	•	•	•	•
"110"	1100	1210	1230	1292	•	•				•	

\*\*\*\* - investment dimension "90E" different for technical and remaining doors  
D - width of the assembly hole

Select the appropriate option of the adjustable panel with masking architrave (Cmin) for a specific wall thickness

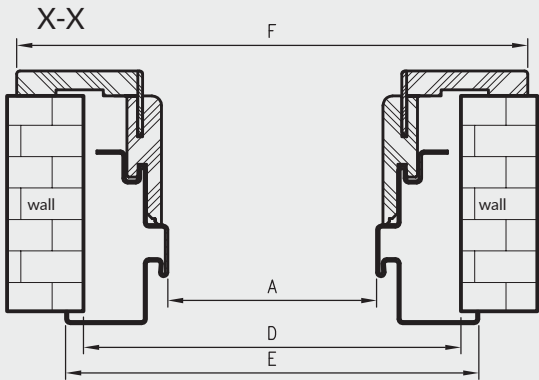

### door frame profile

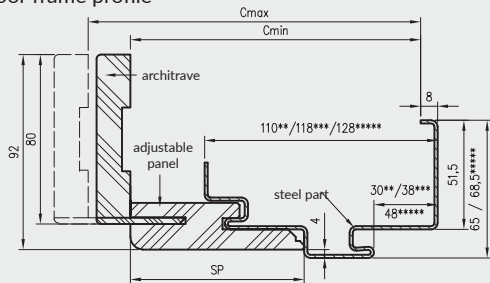

wall thickness range						SP
OSH_ATHOS OSH_FORCA OSH for Olimp EI-30 door leaf		OSH STAND OSH GLASS OSH ENTER OSH SOLID OSH SOLID RC2		OSH OLIMP EI60		
option Cmin	Max	option Cmin	Max	option Cmin	Max	
145	165	137	157	155	175	82
165	185	157	177	175	195	102
185	205	177	197	195	215	122
205	225	197	217	215	235	142
225	245	217	237	235	255	162
245	265	237	257	255	275	182
265	285	257	277	275	295	202
285	305	277	297	295	315	222
305	325	297	317	315	335	242
325	345	317	337	335	355	262
345	365	337	357	355	375	282

Price for double-leaf doors: + 30%

### OSH OLIMP EI30 dimensions for single leaf door

symbol width.	A	D	E	F
"80"	802	912	932	994
"90"	902	1012	1032	1094
"90E"	917	1027	1047	1109
"100"	1002	1112	1132	1194
"110"	1102	1212	1232	1294

### Dimensions OSH OLIMP EI60 for single leaf door

symbol width.	A	D	E	F
"80"	797	907	934	989
"90"	897	1007	1034	1089
"90E"	926	1036	1063	1118
"100"	997	1107	1134	1189
"110"	1097	1207	1234	1289

\*\* - dimensions for remaining OSH frames

\*\*\* - dimensions for OSH ATHOS, OSH FORCA and OSH OLIMP EI 30

\*\*\*\* - dimensions for OSH OLIMP EI 60

Door Frame price = price of the metal part + price of an adjustable panel with a architrave

### Prices for the adjustable panel with masking architrave

### OSH STAND dimensions for double leaf doors

symbol width.	A	D	E	F
"100D"	1032	1142	1162	1224
"110D"	1132	1242	1262	1324
"120"	1232	1342	1362	1424
"130"	1332	1442	1462	1524
"140"	1432	1542	1562	1624
"150"	1532	1642	1662	1724
"160"	1632	1742	1762	1824
"170"	1732	1842	1862	1924
"180"	1832	1942	1962	2024
"190"	1932	2042	2062	2124
"200"	2032	2142	2162	2224

# HYBRID STEEL DOOR FRAMES

NON-REBATED

## Steel Hybrid non-rebated door frames - dimensions

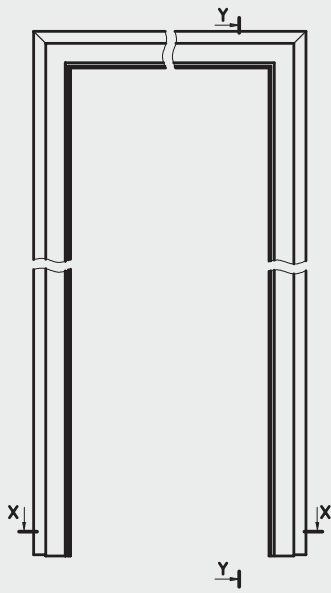

Y-Y Vertical cross-section of OSHB

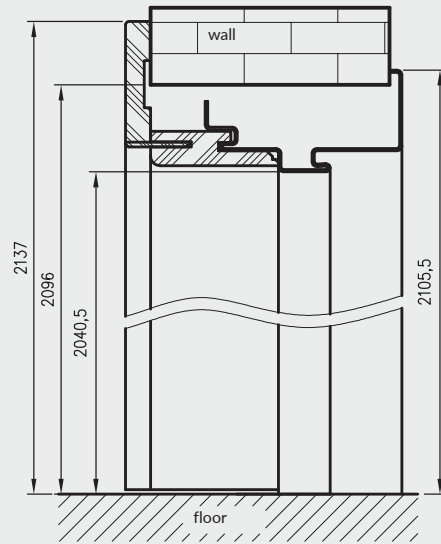

OSHB horizontal cross-section X-X

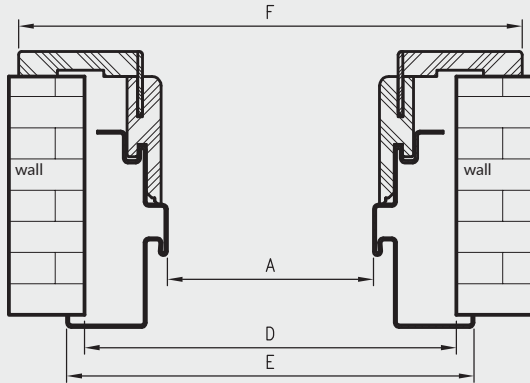

hybrid steel non-rebated door frame profile

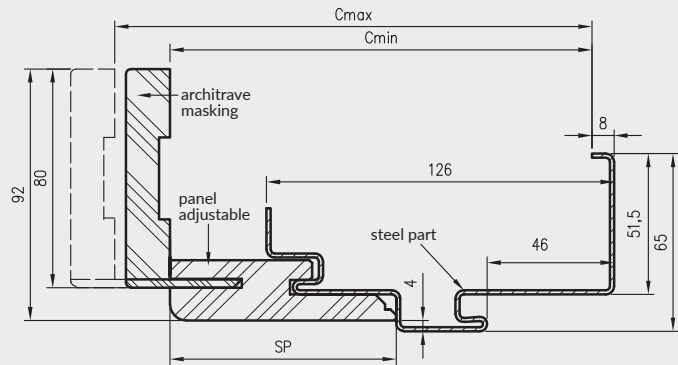

D - width of the assembly hole

Select the appropriate option of the adjustable panel with masking architrave (Cmin) for a specific wall thickness

### Dimensions for single leaf doors

symbol width.	A	D	E	F
"60"	624	734	754	816
"70"	724	834	854	916
"80"	824	934	954	1016
"90"	924	1034	1054	1116
"100"	1024	1134	1154	1216

### Dimensions for double leaf doors

symbol width.	A	D	E	F
„120"	1271	1381	1401	1463
„130"	1371	1481	1501	1563
„140"	1471	1581	1601	1663
„150"	1571	1681	1701	1763
„160"	1671	1781	1801	1863
„170"	1771	1881	1901	1963
„180"	1871	1981	2001	2063

# SMALL ANGULAR STEEL DOOR FRAMES

## CONSTRUCTION:

Steel door frames are made of 1.2 mm thick low-carbon steel sheet, protected with a protective organic varnish coating. The door frame consists of two beams: a hook and a hinged one, and a lintel, permanently connected together by welding. Hinged beams are equipped with hinge sockets (2-3 pcs.), while catch beams have cutouts for the tongue and latches for the lock of a dedicated door leaf (the set includes a cover seal).

## APPLICATION

Small Angular Steel Door Frame - door frame designed for rebated interior doors

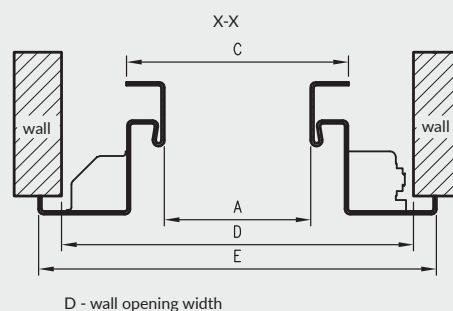
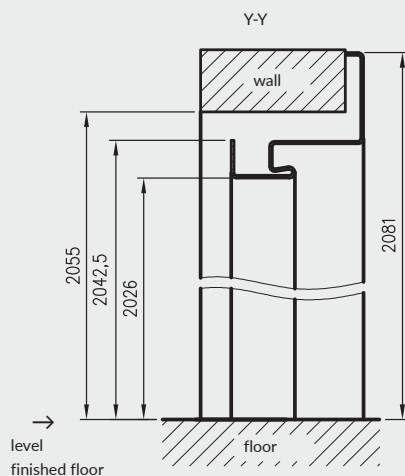
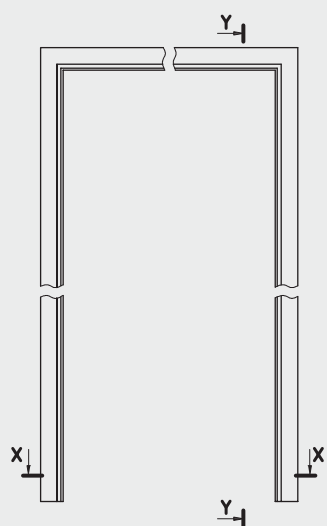

small angular steel door frame profile

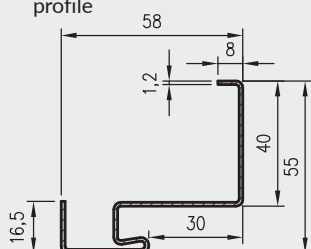

Dimensions for single leaf doors

symbol width.	A	C	D	E
"60"	600	633	690	710
"70"	700	733	790	810
"80"	800	833	890	910
"90"	900	933	990	1010
"90E"	904	937	994	1014
"100"	1000	1033	1090	1110

## AVAILABLE COLOURS

Door frame is powder coated in two gloss scale (matt / low structure or semi-gloss / plain). There are available colours:

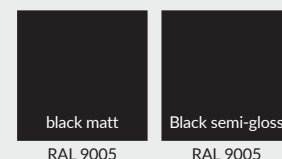

\*\*\* beige colour is available only in semi-gloss

# DOOR HANDLES



POLARIS door handle - chrome  
inserts in DRE-Cell, 3D and CPL colors



simple key  
backplate



cylinder lock  
backplate



toilet lock  
backplate



POLARIS door handle - black matt  
inserts in DRE-Cell, 3D and CPL colors



simple key  
backplate



cylinder lock  
backplate



toilet lock  
backplate



WEGA door handle - satin nickel



simple key  
backplate



cylinder lock  
backplate



toilet lock  
backplate



WEGA door handle - black matt



simple key  
backplate



cylinder lock  
backplate



toilet lock  
backplate



ATRIA door handle - satin nickel



simple key  
backplate



cylinder lock  
backplate



toilet lock  
backplate



ATRIA door handle - black matt



simple key  
backplate



cylinder lock  
backplate



toilet lock  
backplate



ORION door handle - satin nickel



simple key  
backplate



cylinder lock  
backplate



toilet lock  
backplate



# DOOR HANDLES



ORION door handle - black matt



simple key backplate



cylinder lock backplate



toilet lock backplate



ARCTUS door handle - satin nickel



simple key backplate



cylinder lock backplate



toilet lock backplate



door handle MEDA - shiny chrome inserts in DRE-Cell, 3D and CPL colours



simple key backplate



cylinder lock backplate



toilet lock backplate

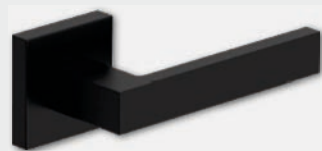

QUBIK door handle - black with antibacterial coating\*



simple key backplate



cylinder lock backplate



toilet lock backplate\*



CUBE SLIM door handle - brushed chrome



simple key backplate



cylinder lock backplate



toilet lock backplate



the CUBE SLIM handle - shiny brass



simple key backplate



cylinder lock backplate

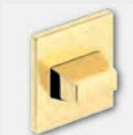

toilet lock backplate



TOTAL door handle - brushed nickel matt



simple key backplate



cylinder lock backplate



toilet lock backplate

\* - the handle and the toilet knobs are covered with an antibacterial coating

# DOOR HANDLES



IBIZA door handle - black matt



CUBE door handle - shiny chrome



CUBE door handle - brushed nickel



CUBE door handle - black matt



MONDO door handle - satin nickel



door handle TREND - satin nickel



door handle LINEA - shiny chrome



LINEA door handle - nickel satin



simple key backplate



cylinder lock backplate



toilet lock backplate



simple key backplate



cylinder lock backplate



toilet lock backplate



simple key backplate



cylinder lock backplate



toilet lock backplate



simple key backplate



cylinder lock backplate



toilet lock backplate



simple key backplate



cylinder lock backplate



toilet lock backplate



simple key backplate



cylinder lock backplate



toilet lock backplate



simple key backplate



cylinder lock backplate



toilet lock backplate



simple key backplate



cylinder lock backplate



toilet lock backplate

# DOOR HANDLES



QUANTA Fit door handle - brushed brass



door handle BELLA SLIM - glossy brass



door handle ZORBA - shiny chrome/satin



QUIK Fit door handle - black



door handle NOVA - stainless steel



PROXIMA door handle - stainless steel



TOPAZ door handle - stainless steel



TOPAZ door handle - stainless steel, black matt

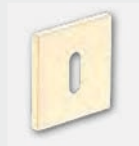

simple key backplate

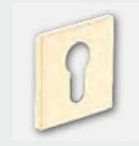

cylinder lock backplate



toilet lock backplate



simple key backplate

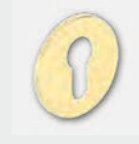

cylinder lock backplate

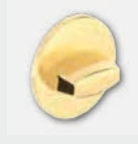

toilet lock backplate



simple key backplate

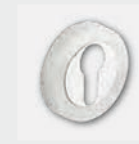

cylinder lock backplate

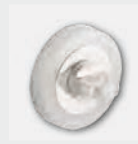

toilet lock backplate



simple key backplate

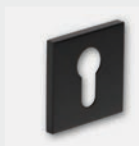

cylinder lock backplate



toilet lock backplate



simple key backplate



cylinder lock backplate



toilet lock backplate



simple key backplate



cylinder lock backplate



toilet lock backplate



simple key backplate



cylinder lock backplate



toilet lock backplate



simple key backplate



cylinder lock backplate



toilet lock backplate

# DOOR HANDLES



handle JOWISZ - stainless steel



simple key backplate



cylinder lock backplate



toilet lock backplate



LUNA SLIM door handle - brushed chrome



simple key backplate



cylinder lock backplate



toilet lock backplate



LUNA slim door handle - shiny brass

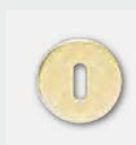

simple key backplate

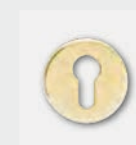

cylinder lock backplate

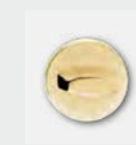

toilet lock backplate



IBIZA door handle - graphite/chrome



simple key backplate



cylinder lock backplate



toilet lock backplate



door handle IBIZA - nickel satin



simple key backplate



cylinder lock backplate



toilet lock backplate



door handle IBIZA - shiny chrome



simple key backplate



cylinder lock backplate



toilet lock backplate



handle BETA - nickel satin



simple key backplate



cylinder lock backplate



toilet lock backplate



EUROPA door handle - nickel satin



simple key backplate



cylinder lock backplate



toilet lock backplate

# DOOR HANDLES



TOMA door handle - black



simple key backplate



cylinder lock backplate



toilet lock backplate



STARK Fit door handle - black



simple key backplate



cylinder lock backplate



toilet lock backplate



WARNA door handle - satin nickel



simple key backplate



cylinder lock backplate



toilet lock backplate



door handle ALVA LUX - black matt

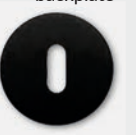

simple key backplate

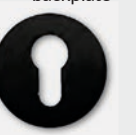

cylinder lock backplate

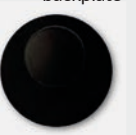

toilet lock backplate



PEM LUX door handle - black matt



simple key backplate



cylinder lock backplate



toilet lock backplate



AS LUX door handle - titanium



simple key backplate

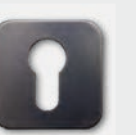

cylinder lock backplate



toilet lock backplate



LEA LUX door handle - gold matt



simple key backplate

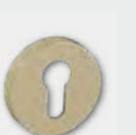

cylinder lock backplate

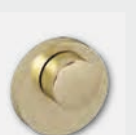

toilet lock backplate



FOKUS door handle - nickel satin velvet



simple key backplate

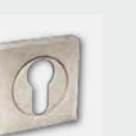

cylinder lock backplate



toilet lock backplate

# DOOR HANDLES



UNO door handle - stainless steel



simple key backplate



cylinder lock backplate

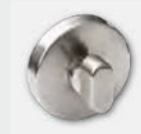

toilet lock backplate



ROMAN door handle - chrome/nickel lacquered



simple key backplate



cylinder lock backplate



toilet lock backplate



TIK-QR door handle - anthracite



simple key backplate



cylinder lock backplate



toilet lock backplate



QUBIK door handle - lacquered nickel



simple key backplate



cylinder lock backplate



toilet lock backplate



LIBRA door handle - satin nickel



Simple key backplate



cylinder lock backplate



toilet lock backplate

Note: long backplates do not fit doors with magnetic lock



ZORBA door handle with oblong backplate  
long backplate - shiny chrome /



ZORBA door handle with a long simple key backplate - shiny chrome/satin (spacing 72 mm)



ZORBA door handle with oblong backplate for cylinder lock - shiny chrome/satin (span 72 mm)



ZORBA door handle with oblong long bathroom backplate - shiny chrome / satin (spacing 72 mm)



door handle SHARK black and inox  
door handle SZARK for the SOLID / ENTER

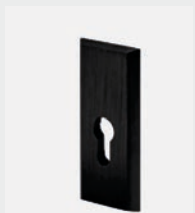

backplate SHARK black and inox



door handle DIVA and backplate for door leaves FORCA 10 and FORCA B 10 silver F1 door handle long backplate



ONTARIO door handle and backplate for SOLID RC2 model silver colour F1 door handle long backplate



# DOOR HANDLES



STAR TEC technical handle - class IV - stainless steel matt price for a set (handle + cylinder lock backplate)

door leaf thickness up to 55 mm

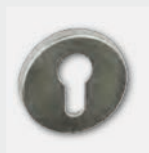

cylinder lock backplate



PEGAZ door handle (span 72 mm) black matt with cylinder lock



door handle TOM with oblong backplate for cylinder lock (span 72 mm) matt chrome

exterior backplate

interior backplate

NOTE:  
selection of left or right door handle\*.  
Door handle in set with backplate is adapted to door leaf with two locks except for SOLID collection.

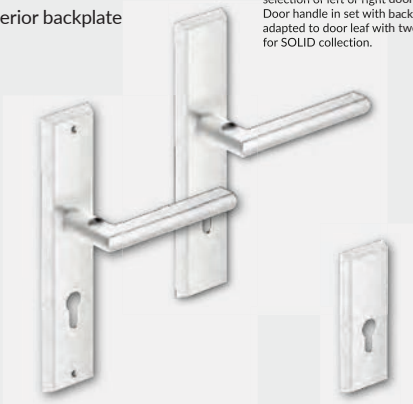

handle METRO (span 72 mm) stainless steel for cylinder lock

upper backplate METRO stainless steel for cylinder lock

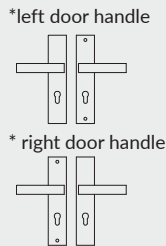

NOTE:  
Door handle in set with backplate is adapted to door leaf SOLID with two locks.

exterior TOTAL door handle with long backplate (72 mm span) inox plus -



short upper backplate TOTAL short inox plus

Note: long backplates do not fit doors with magnetic lock

## CYLINDER LOCK INSERTS



insert 26/41 - nickel matt



insert 26/41 - satin brass



set of cylinder lock inserts ZN 30/40+30G/40 SN or ZN 30/40+40G/30 SN satin nickel



set of cylinder lock inserts ZN 30/40+30G/40 SB or ZN 30/40+40G/30 SB brass satin



set of inserts ZN 27/40+27G/40 or ZN 27/40+40G/27 satin nickel



insert 30/30 - satin nickel



insert 35/35 - satin nickel



insert 30/40 - satin

## SELF-CLOSER

DORMA TS-90 impuls self closer Price.....



DORMA TS-71 selfcloser Price.....



GEZE TS 2000 selfcloser Price.....



# DECORS

<b>P</b> CELL	white (wood grain structure)	white matt	white pine	siberian elm	silver	sand oak
<b>R</b> CELL						
<b>W</b> CELL	bleached oak textured	vintage oak	light gray mat	marrone chestnut textured	evoked oak	toffee oak <sup>*</sup> , <sup>***</sup>
	anthracite elm	golden oak textured	walnut	caramel walnut	dark wenge	oxide concrete
	antique copper	black matt 2	dark olive matt	dark blue matt	<b>NEW</b> cashmere matt	<b>NEW</b> warm gray matt
	<b>NEW</b> sage oak					
<b>P</b> FINISH	alpine white	bleached craft oak	riviera oak	rustic oak		
<b>P</b> 3D	walnut american	ebony <sup>*</sup>	elm			
<b>R</b> 3D						
<b>W</b> 3D	Polish oak 3D	grand oak				
<b>P</b> SYNCHRO	gray halifax oak	natural halifax oak	Halifax Tabac Oak	white elm	natural elm	dark elm
<b>R</b> SYNCHRO						

\* decor available while stocks last,  
 \*\* decor available only in horizontal wood grain





# DECORS



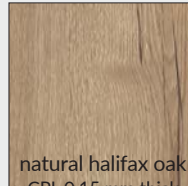

						
milky white	gray oak	welsh oak	walnut	celini walnut	concrete 2	
CPL 0,2 mm thick CPL 0,7 mm thick	CPL 0,2 mm thick CPL 0,7 mm thick	CPL 0,2 mm thick CPL 0,7 mm thick	CPL 0,2 mm thick CPL 0,7 mm thick	CPL 0,2 mm thick CPL 0,7 mm thick	CPL 0,2 mm thick CPL 0,7 mm thick	

					
acacia	honey oak	chestnut	roasted walnut	ashen	DARK GRAY
CPL 0,2 mm thick CPL 0,7 mm thick	CPL 0,2 mm thick CPL 0,7 mm thick	CPL 0,2 mm thick CPL 0,7 mm thick	CPL 0,2 mm thick CPL 0,7 mm thick	CPL 0,2 mm thick CPL 0,7 mm thick	CPL 0,2 mm thick CPL 0,7 mm thick



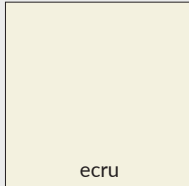



\*Black ST decor - Tecofoil protected twice with pigmented, matt varnish. The decor is assigned to the CPL price group, however it is not a CPL laminate.

		
white	black ST*	natural halifax oak
W0118 CPL 0,15 mm thick CPL 0,7 mm thick		CPL 0,15 mm thick Door frames only

\*\* RAL, NCS, FLUGGER values are approximate values and closest to the color of the door leaf

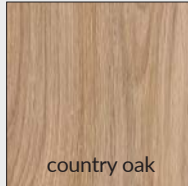
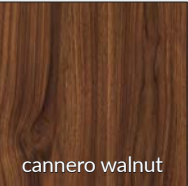
				
white	ecru	latte	ashen	
UV acrylic lacquer RAL=9003**	RAL=9001**	Flugger = 4362 NCS = S1505-Y50R**	RAL=7035**	

## LUX collection decors

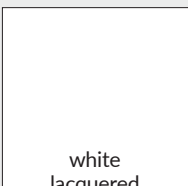
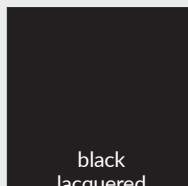
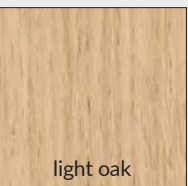
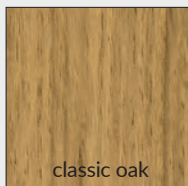
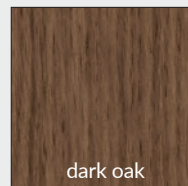
						
pavio oak	viking oak	country oak	cannero walnut	birch	wenge	
						
uranus	white lacquered	black lacquered	light oak	classic oak	dark oak	

## Decors from CLARO and GRAFI collections,

## WOOD collection decors

				
white	bleached craft oak	gold craft oak	shirin walnut	

# DRE-PRINT collection G

NON-REBATED DOOR LEAF  
interior door leaf



Scaling of the patterns in G1 - G6 graphics in the selected door leaves widths right opening

G1 graphic pattern



"60"

G2 graphic pattern



"60"

G3 graphic pattern



"60"

G4 graphic pattern



"60"

G5 graphic pattern



"60"

G6 graphic pattern



"60"



"70"



"70"

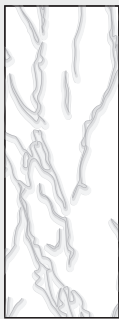

"70"

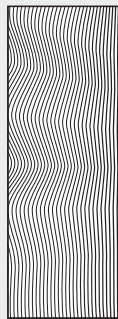

"70"

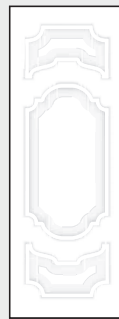

"70"



"70"



"90"



"90"



"90"

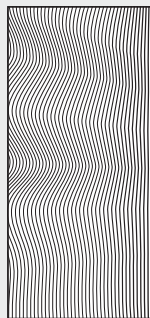

"90"



"90"



"90"



"100"



"100"



"100"

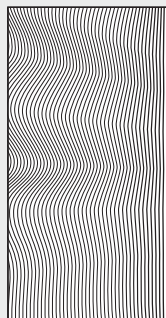

"100"

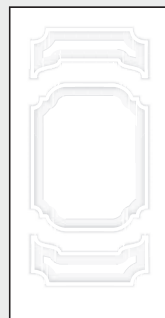











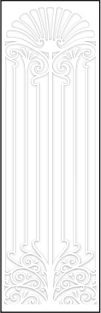





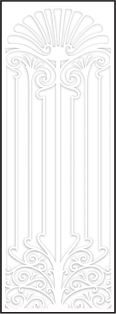

"100"



"100"

Scaling of graphics patterns in the width of the door leaf "80" is presented on page 54 and 55

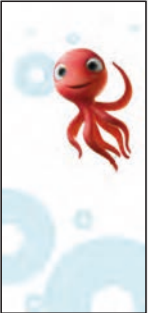
## Scaling of the patterns in G7 - G12 graphics in the selected door leaves widths right opening

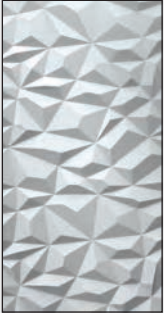
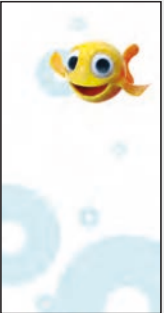
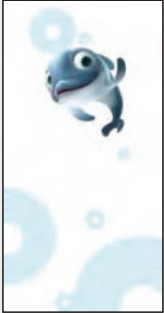
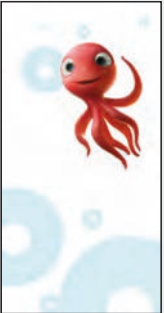
G7 graphic pattern	G8 graphic pattern	G9 graphic pattern	G10 graphic pattern	G11 graphic pattern	G12 graphic pattern
					
"60"	"60"	"60"	"60"	"60"	"60"
					
"70"	"70"	"70"	"70"	"70"	"70"
					
"90"	"90"	"90"	"90"	"90"	"90"
					
"100"	"100"	"100"	"100"	"100"	"100"

Scaling of graphics patterns in the width of the door leaf "80" is presented on page 54 and 55

# DRE-PRINT collection G

NON-REBATED DOOR LEAF  
interior door leaf



Scaling of the patterns in G13 - G18 graphics in the selected door leaves widths right opening

G13 graphic pattern

G14 graphic pattern

G15 graphic pattern

G16 graphic pattern

G17\* graphic pattern

G18\* graphic pattern



"60"

"60"

"60"

"60"

"60"

"60"



"70"

"70"

"70"

"70"

"70"

"70"



"90"

"90"

"90"

"90"

"90"

"90"



"100"

"100"

"100"

"100"

"100"

"100"

Scaling of graphics patterns in the width of the door leaf "80" is presented on page 54 and 55  
\* pattern versions available for the right and left door leaf

## Scaling of the patterns in G19 - G25 graphics in the selected door leaves widths right opening

G19 graphic pattern G20\* graphic pattern G21 graphic pattern G22 graphic pattern G23 graphic pattern G24\* graphic pattern G25 graphic pattern

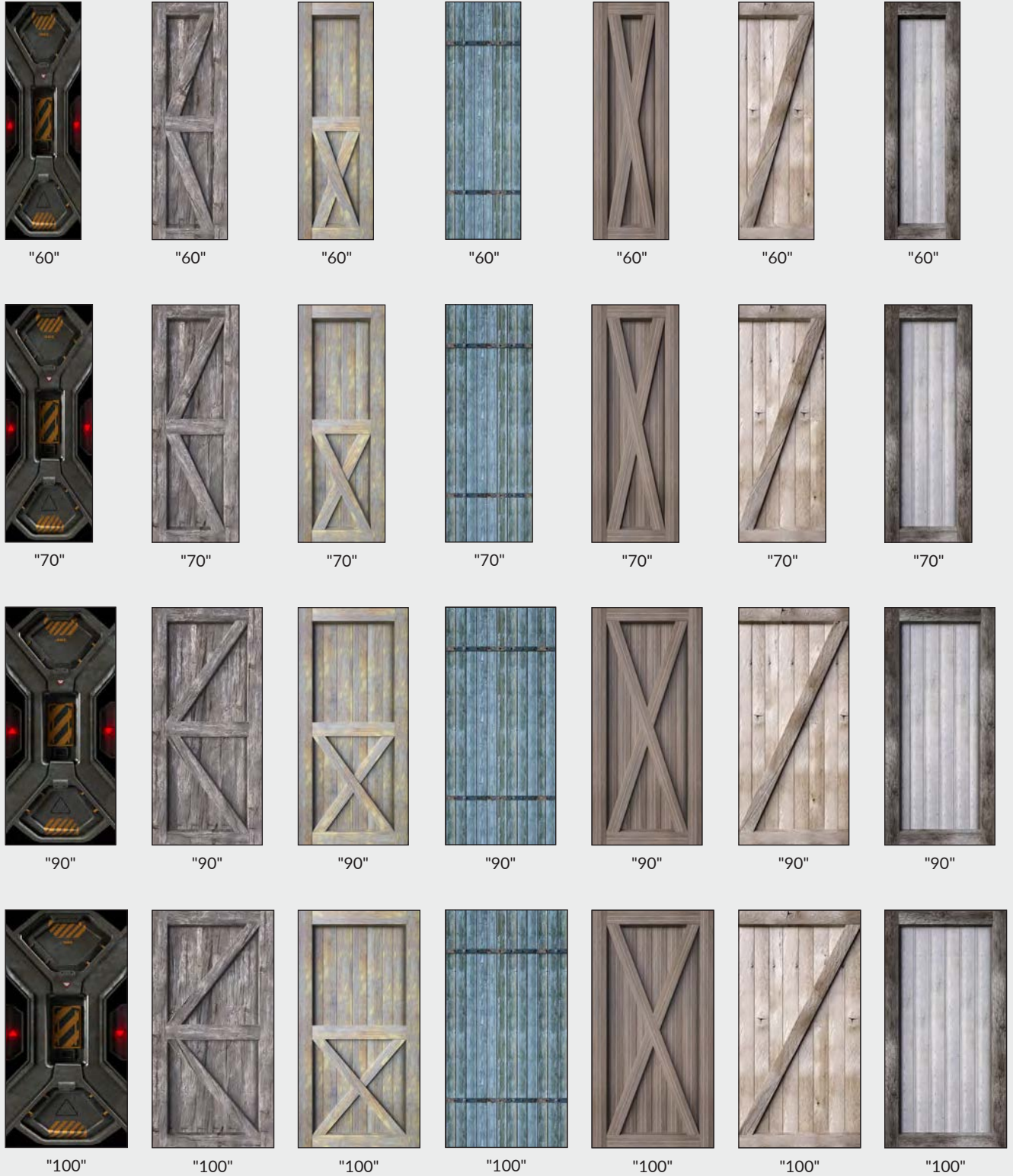

Scaling of graphics patterns in the width of the door leaf "80" is presented on page 54 and 55  
\* pattern versions available for the right and left door leaf

# GLASS PANE PATTERNS

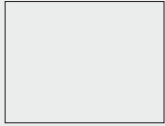

pattern 1 VETRO  
transparent

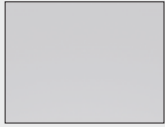

pattern 1 VETRO  
decormat



pattern 1 VETRO  
decormat brown



pattern 1 VETRO  
decormat graphite



pattern VETRO E, VETRO  
D1  
black opaque laminated  
glass



VETRO pattern E  
laminated glass  
decormat



pattern 2 VETRO

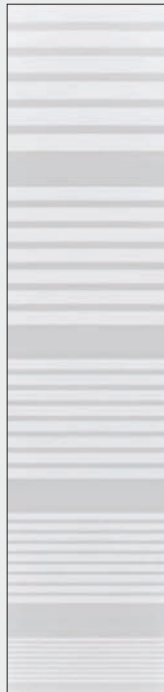

pattern 3 VETRO



pattern 4 VETRO

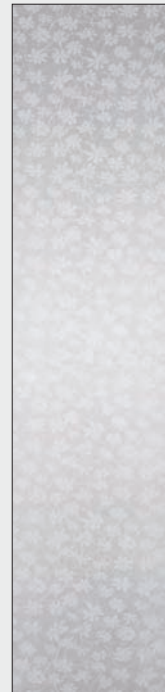

pattern 5 VETRO



pattern 10 VETRO



pattern 11 VETRO

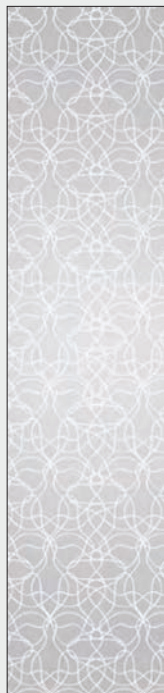

pattern 12 VETRO



pattern 13 VETRO

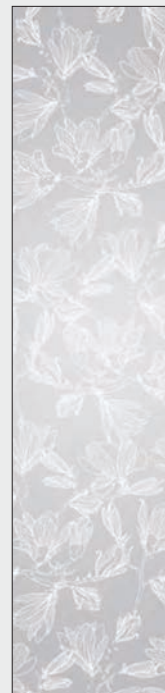

pattern 14 VETRO



pattern 15 VETRO

# GLASS PANE PATTERNS



mat dre

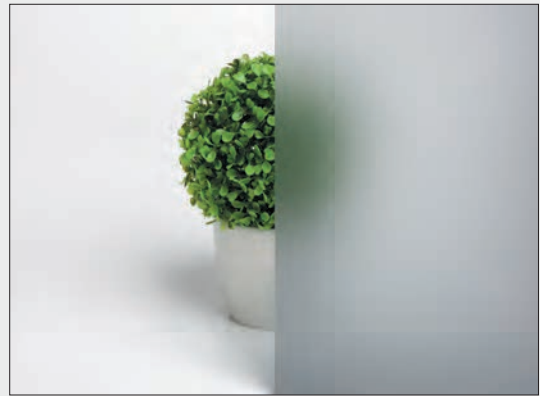

deformat graphite



white frost laminated VSG 22.1, plain on both sides

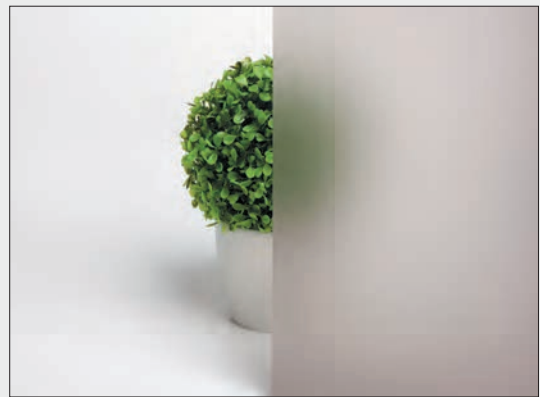

deformat brown



window blind



chinchila



white bark



VSG black

## PRICES

Prices and availability of glass are given on the pages with door leaves. The glass in the doors of our collections has an obverse and a reverse (except VSG 22.1 and VETRO E, VETRO D1).

# ARCHITRAVES AND SKIRTING BOARDS

## KT2 ARCHITRAVE

The KT2 80 mm and 63 mm architrave increases the adjustment range of the standard adjustable OR door frame by +15 mm. The architrave must be ordered separately as a separate accessory. The price of the architrave is available at the Distributor.

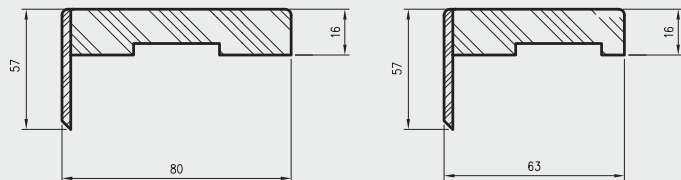

## ARCHITRAVES

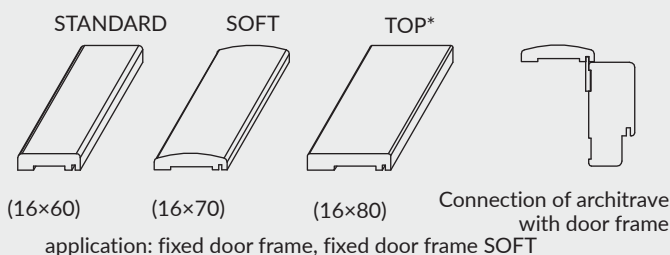

### Set contains (for one side of the door):

horizontal and two vertical masking architraves, plastic latch strike plates, pins and clamp clips. Masking architraves are packed in a cardboard box.

## QUARTER ROUNDS

The quarter round is used to mask the angular connection of the wall and the door frame. The trading unit is 1 pc. prices of quarter rounds

Quarter rounds require cutting before the assembly.

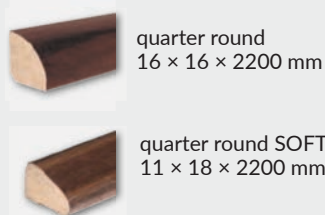

## SKIRTING BOARDS



Length of skirting boards 2.62 meters (except for LPP4W). Skirting boards require cutting before assembly.

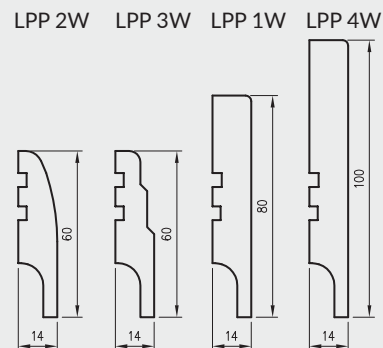

Length of LPP4W is 2,40 mb  
It is made of moisture resistant board.

## VENTILATION GRILLE

There is possibility to instal bathroom plastic ventilation grille, which is available in the following colours: white, beige, calvados, brown, silver, creamy, gray, black and ashen (except for frame construction doors, sliding doors, fire resistant doors and SOLID, ENTER) or aluminum ventilation grille

- » plastic ventilation grille
- » aluminum ventilation grille



plastic ventilation grille



aluminum ventilation grille



# VENTILATION ACCESSORIES AND OTHER

## VENTILATION SLEEVES FOR PANEL DOORS

There is possibility to purchase a set (5 pcs) of ventilation sleeves.  
DRE-Cell Decor , 3D foil, CPL laminate.



## VENTILATION SLEEVES FOR FRAME CONSTRUCTION DOOR LEAF

For frame construction doors, except for VETRO with plastic sleeves (3 sleeves for doors "60", 4 sleeves for doors "70", 5 sleeves for doors "80"- "100")

## PLASTIC VENTILATION SLEEVES



## VENTILATION UNDERCUT

In all collections (except SOLID, SOLID RC2, ENTER, FIRE resistant door leaves, sliding doors, folding), ventilation undercut can be made upon request.



ventilation undercut

## 13.5 MM HINGE FOR REBATED DOORS

» (set of lower and upper part)  
13.5 mm diameter hinge in black.



## HINGE COVERS

» (set of 2 pcs. for 1 hinge)  
Plastic hinge covers are adjusted to hinges with diameter of 13.5 mm.



## thimble

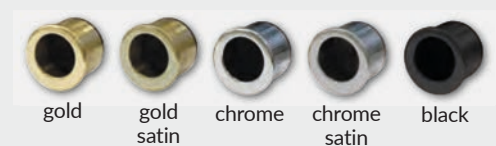

# TECHNICAL INFORMATIONS

## DOOR LEAF DIMENSION AND PLACEMENT OF HINGES

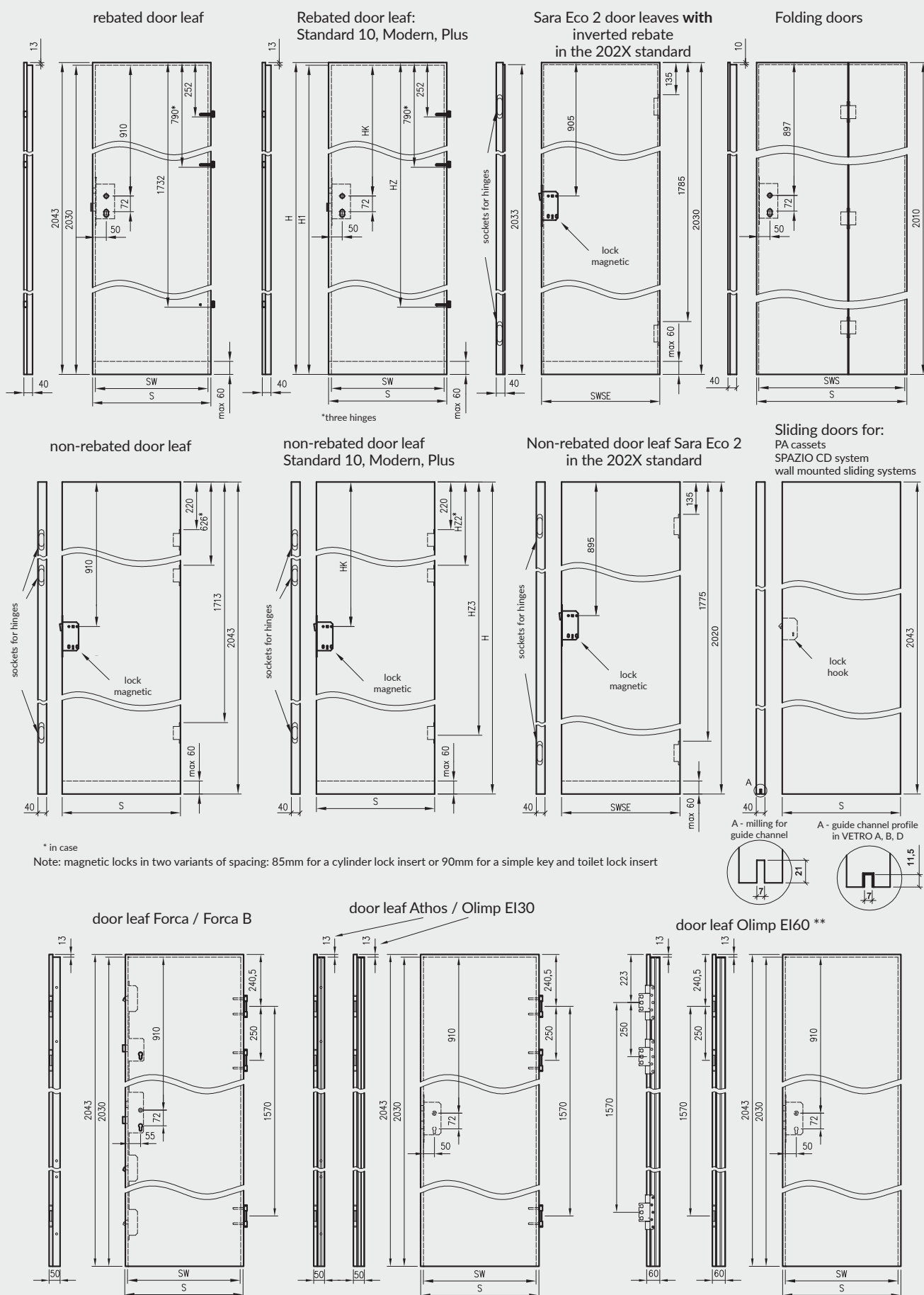

\*\* Olimp EI60 two options of hinges (depending on the width of the door)

# TECHNICAL INFORMATIONS

## DOOR LEAF WIDTH

Symbol of the door dimension	S	SW	SWSE	SWS
"60"	644	618	620	-
"70"	744	718	720	-
"80"	844	818	820	824
"90"	944	918	920	924
"100"	1044	1018	1020	1024
"110*"	1144	1118	-	-

S - total door leaf width  
 SW - width in the rebate (refers to rebated door leaf)  
 SWSE - Sara Eco 2 leaf width  
 SWS - width in the rebate of folding door leaf  
 \* - width "110" is only available in door leaves Standard 10, Athos, Enter Acoustic and Olimp

**NOTE:** Total width of "40" side panels is 444 mm.

## ADDITIONAL LEAF WIDTHS

Symbol of the door dimension	S	SW
"90E" for OLIMP EI30, ATHOS, FORCA, FORCA B.	959	933
"90E" for OLIMP EI60	973	947
"90E" for STANDARD, ENTER, ENTER AKUSTIK, SOLID, SOLID RC2	948	922

The investment standard "90E" provides 900mm passage in the door frame with the door leaf opened at an angle of 90°

## DIMENSIONS OF THE DOOR LEAF WITH 4 VARIABLE HEIGHTS

(refers to door leaf STANDARD 10 and collections MODERN and PLUS)

H	H1	HK	HZ	HZ2	HZ3
1983	1970	850	1672	606	1653
2043	2030	910	1732	626	1713
2110	2097	977	1799	647	1780
2240	2227	1107	1929	691	1910

H - total height of the door leaf  
 H1 - door leaf height in the rebate  
 HK - distance from the top rebate of door leaf to the axis of the handle  
 HZ - distance from the upper edge of the door leaf to the mounting point of the third hinge

## DOOR LEAF HEIGHT

2043 mm - total height of rebated and non-rebated door leaf (2010 for folding doors)

2030 mm - height of the rebated door leaves in the rebate (2020 for Sara Eco 2 door leaves with the inverted rebate, 2000 for folded doors)

2055 mm - total height of the door leaves with inverted rebate

1983, 2043, 2110, 2240 mm - total possible height of STANDARD 10 door leaf and MODERN and PLUS collection (1970, 2030, 2097, 2227 mm - measured in the door leaf rebate)

## SHORTENING OF DOOR LEAF

There is possibility to shorten the door leaf on your own, up to 60 mm (there is no possibility to shorten following door leaf: VETRO, FIRE RESISTANT DOORS, FORCA B, door leaf of all collections in the sliding version, passive doors, glass doors, folding doors and door leaves with dropping seal).

**Note:** The door leaf with recuperative undercutting - 15 mm, is adapted to shortening on your own, up to 45 mm Max.

## CLEARANCE BETWEEN DOOR LEAF AND FLOOR

standard clearance between door leaf and finished floor is 8 mm high ( 15 mm in FOLDE door leaf, 5-6 mm in OLIMP door leaf).

## NOTES REFERED TO HINGE

In rebated door leaves: frame construction door leaves, entrance door leaves (Enter, Enter Akustik, Solid) and other collections with a width of not less than "90", 3 pcs. of screw-in hinges ø 13.5 mm are installed. In other rebated interior doors, it is possible to choose 2 or 3 hinges.

In SOLID RC2, FORCA, FORCA B, ATHOS and OLIMP EI30 door leaf there are mounted 3 threefold hinges.

The OLIMP EI60 leaves, depending on the width, are equipped with 3 three-part hinges or 3 SIMONSWERK hinges VX 7939/160.

Non-rebated door leaf come with pre-milled sockets for two or three hidden concealed hinges which are attached together with non-rebated door frame.

Sara Eco 2 door leaves with inverted rebate and non-rebated doors have milled sockets for recessed hinges, which are packed together with the door frame.

Folding doors come with 3 hidden recessed hinges which join two parts of door leaf.

Door leaves with inverted rebate have sockets for two concealed hinges, which are packed together with door frame.

### Non-rebated door leaf

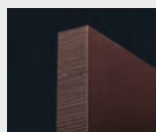

edge without rebate



lock magnetic



hinge recessed hinge

### REBATED DOOR LEAF

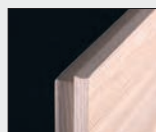

fixed edge

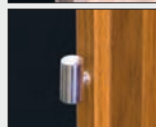

hinge screw-in

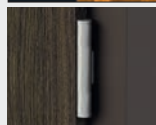

threefold hinge



threefold hinge



SIMONSWERK VX 7939/160 hinge

# TECHNICAL INFORMATIONS

## DOOR LEAF THICKNESS AND SELECTION OF CYLINDER INSERT

Door leaf type	Door leaf thickness	proportion in the door leaf (W0/Z0)	recommended** dimension of the cylinder insert (W/Z)	Refers to cylinder insert with door knob	
				Cylinder insert with a knob on the inside (W/Z)	Cylinder Insert with a door knob outside (W/Z)
rebated door leaf	40	14 / 26	25 / 40 ; 26 / 36 26 / 41 ; 30 / 40	25G/40; 26G/36 26G/41; 30G/40 27G/40	25/40G; 26/36G 26/41G; 30/40G 27/40G
Sara Eco 2 inverted rebate door leaves	40	24 / 16	35 / 30 ; 36 / 26 36 / 31 ; 40 / 30	35G/30; 36G/26 36G/31; 40G/30	35/30G; 36/26G 36/31G; 40/30G
Non-rebated door leaf	40	20 / 20	31 / 31 ; 30 / 30 35 / 35	31G/31; 30G/30 35G / 35	
Profi non-rebated door leaves	50	25/25	35/35; 36/36 40/40; 41/41	35G/35 ; 36G/36 41G/41 ; 40G/40	
Non-rebated door leaf Sara Eco 2	40	16 / 24	30 / 35 ; 26 / 36 31 / 36 ; 30 / 40	30G/35; 26G/36 31G/36; 30G/40	30/35G; 26/36G 31/36G; 30/40G
Door leaf with inverted rebate	40	27 / 13	40 / 25 ; 41 / 26	40G/25; 41G/26	40/25G; 41/26G
Profi Door leaf with inverted rebate	50	30/20	40/30; 41/31 45/35	40G/30 ; 41G/31 45G/35	40/30G ; 41/31G 45/35G
Folding doors	40	17/23	30/35; 31/36 30/40	30G/35; 31G/36 30G / 40	30/35G; 31/36G 30 / 40G
fire resistant. ATHOS	50	21 / 29	31 / 41 ; 35 / 40	31G/41; 35G/40	31/41G; 35/40G
Olimp EI30	50	18 / 32	30 / 45 ; 31 / 46	30G/45; 31G/46	30/45G; 31/46G
Olimp EI60	60	28 / 32	40 / 45 ; 41 / 46	40G/45; 41G/46	40/45G; 41 / 46G
fire resistant. FORCA	50	22 / 28	35 / 40		
SOLID RC2	40,6	14 / 26,6	26 / 40 ; 26 / 41 30 / 40		

Cylinder inserts are reversible - that is 25/40 = 40/25, 26G/36 = 36/26G

\*\*recommended dimensions (assuming that backplate is 10 mm thick, and patented cylinder doesn't exceed 5 mm above backplate).

fig. selection of cylinder insert dimension

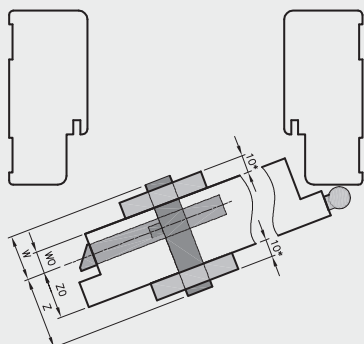
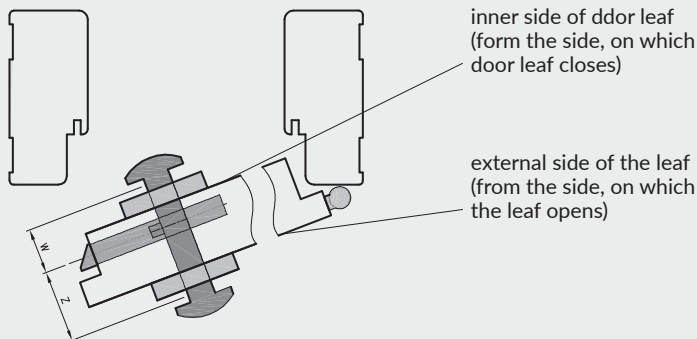

fig. selection of cylinder insert dimension with door knob



Dimension of cylinder insert is calculated using the following formula:

$$WO + \text{backplate thickness} + 2 \div 3\text{mm} / ZO + \text{backplate thickness} + 2 \div 3\text{mm}$$

where:

WO and ZO - values have been presented in the table above  
thickness of the backplate - measured (presented values in above table assume that backplate is 10mm thick)

Selection of backplate with door knob - if we want to mount a knob on:

- the inner side of door leaf - symbol of the door knob must be next to "W" dimension (see column 5 in the table)

- the external side of the leaf - symbol of the door knob must be next to "Z" dimension (see column 6 in the table)

# TECHNICAL INFORMATIONS

## SINGLE LEAF REBATED DOOR

We offer left, right and central door leaf

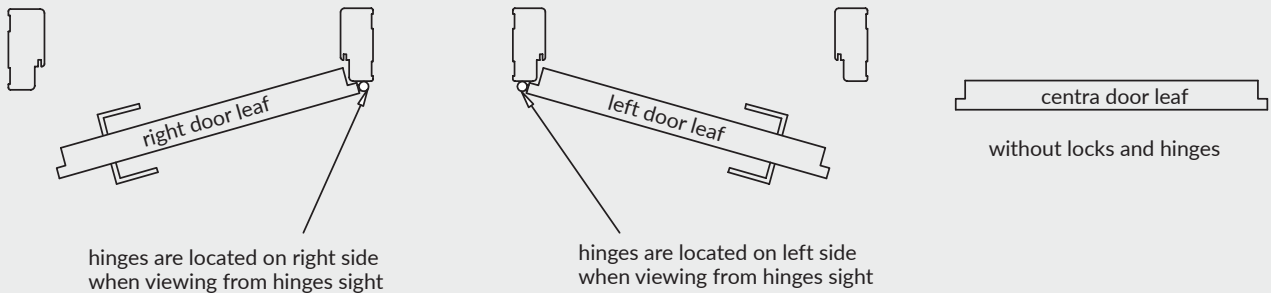

## DOUBLE LEAF REBATED DOOR

We offer double leaf doors: the right - then right door leaf becomes an active one and left door leaf becomes inactive, and double left leaf - left leaf is an active one and the right one is inactive.

The active door leaf has a rebate and a lock as a standard. For double-leaf doors, the edge on the side where the active leaf lock is located and the passive leaf on the side where the catch is located is always a straight edge.

Inactive door leaf comes with a "counter rebate" and additionally is equipped with a latch strike plate and a flush bolt as a standard fitting (A)

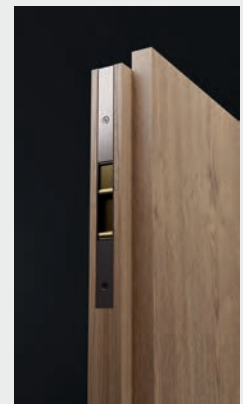

flush bolt (A)

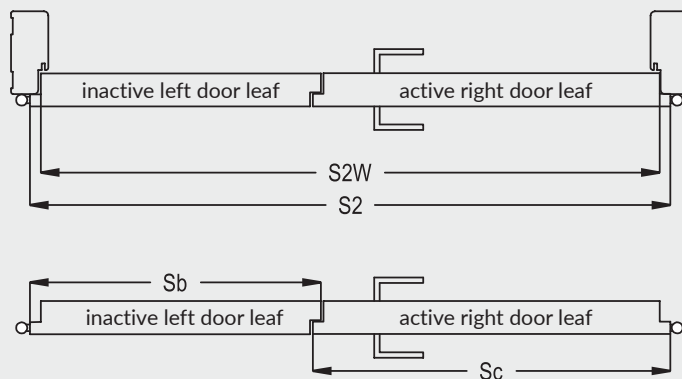

Only door frames produced by DRE fit double-leaf doors, that is the reason that we recommend to our customers to buy doors as a complementary sets. Whole DRE set comprises of 2 door leaf and door frame.

$$\boxed{\text{price of double leaf door}} = \boxed{\text{leaf price} \times 2} + \boxed{\text{price of the fire resistance}}$$

Symbol of door dimension	dimension in [mm]		
	S2	S2W	combination* Sc+Sb
"100d"	1078	1052	644+444
"110d"	1178	1152	744+444
"120"	1278	1252	844+444; 644+644
"130"	1378	1352	944+444; 744+644; 644+744
"140"	1478	1452	1044+444; 844+644; 744+744; 644+844
"150"	1578	1552	944+644; 844+744; 744+844; 644+944
"160"	1678	1652	1044+644; 944+744; 844+844; 744+944; 644+1044
"170"	1778	1752	1044+744; 944+844; 844+944; 744+1044
"180"	1878	1852	1044+844; 944+944; 844+1044
"190"	1978	1952	1044+944; 944+1044
"200"	2078	2052	1044+1044

combination\* possible combination of active (Sc) and inactive (Sb) leaf width

# TECHNICAL INFORMATIONS

## NON-REBATED DOOR LEAF - SLIDING VERSION

We offer left, right and central door leaf (door leaf without a lock and handle)

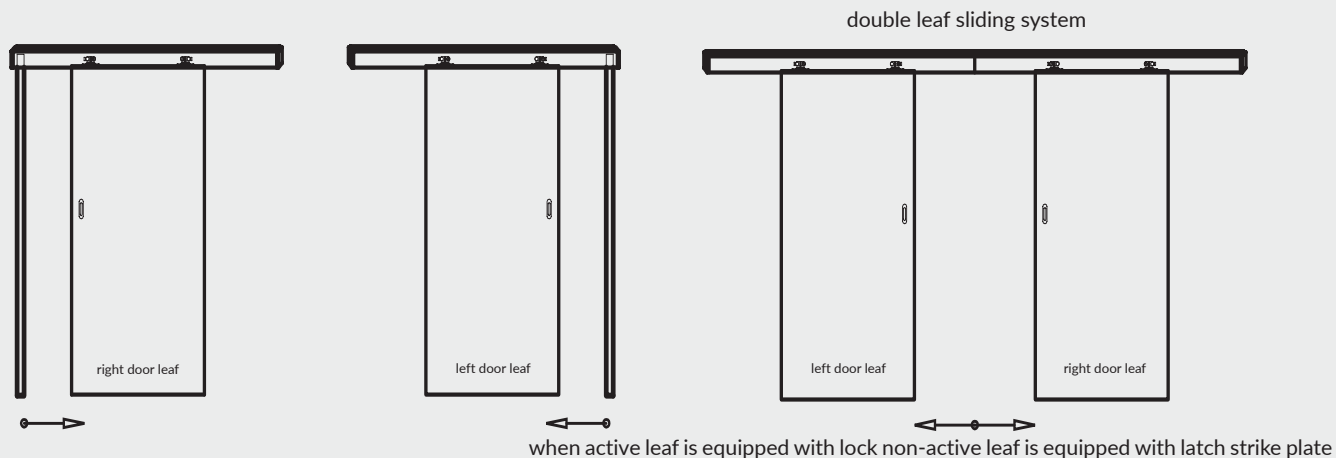

## SINGLE LEAF DOOR NON-REBATED

We offer left, right and central door leaf

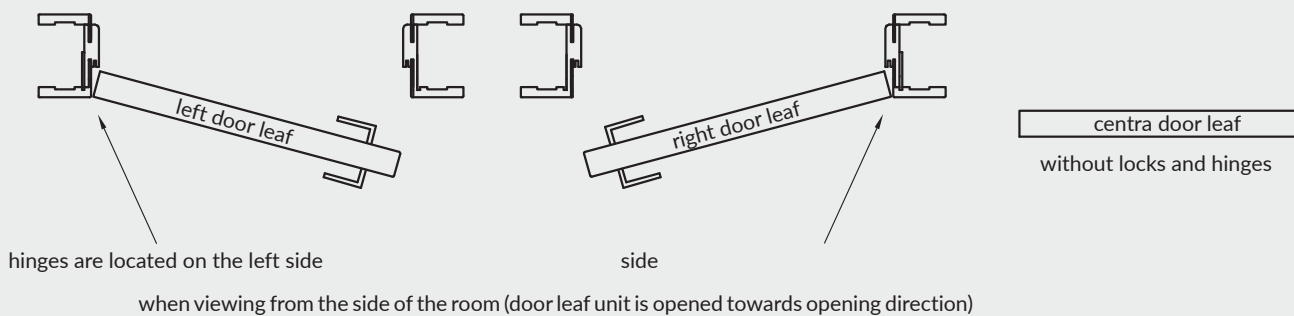

## DOUBLE LEAF NON-REBATED DOOR

We offer double leaf doors: the right - then right door leaf becomes an active one and left door leaf becomes inactive, and double left leaf - left leaf is an active one and the right one is inactive.

An active door leaf has lock as a standard option. Inactive door leaf is equipped with a latch strike plate and a flush bolt as a standard fitting.

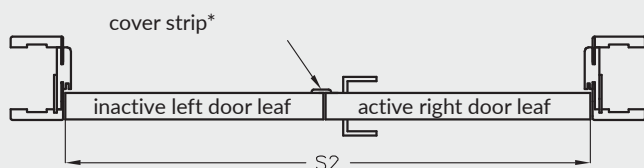

\* for double leaf non-rebated doors there is possibility to purchase cover stripe width of cover stripe 30 mm

$$\boxed{\text{price of double leaf door}} = \boxed{\text{leaf price} \times 2} + \boxed{\text{price of the fire resistance}}$$

Symbol of door dimension	dimension in [mm]	
	S2	combination* Sc+Sb
"120"	1291	644+644
"130"	1391	744+644; 644+744
"140"	1491	844+644; 744+744; 644+844
"150"	1591	944+644; 844+744; 744+844; 644+944
"160"	1691	1044+644; 944+744; 844+844; 744+944; 644+1044
"170"	1791	1044+744; 944+844; 844+944; 744+1044
"180"	1891	1044+844; 944+944; 844+1044

combination\* - possible combination of active (Sc) and inactive (Sb) leaf width

# TECHNICAL INFORMATIONS

## CONSTRUCTION OF PANEL DOORS

- » door leaf frame made of coniferous wood or MDF
- » Core: stabilising insert "honeycomb" (A), perforated chipboard (B) and in fire proof doors: chipboard
- » External 3mm HDF board or external HDF 4mm board (in Finea, Finea B, Enter, Enter Acoustic, Solid)
- » type of edge straight or without rebate

External boards of door leaf is finished with:

- a) in DRE-Cell Decor collection - decorative foil based on the polypropylene
- b) in 3D foil - 3D foil based on decorative paper
- c) in CPL laminate - CPL laminate th. 0.15-0.2mm or 0.7 mm

Fire resistant door leaf Olimp EI30

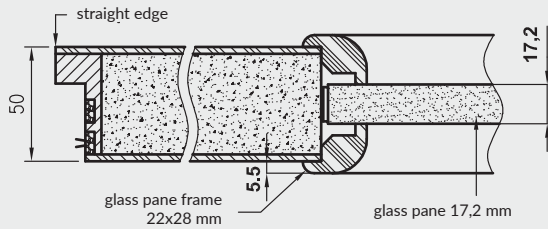

Fire resistant door leaf Olimp EI60

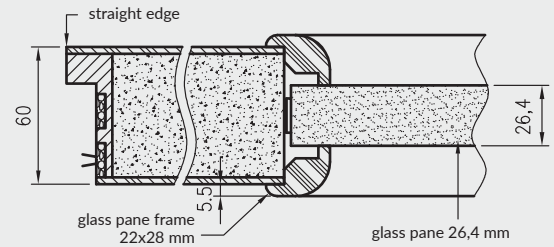

Anti-burglary door and fire-resistant door leaf Forca EI30

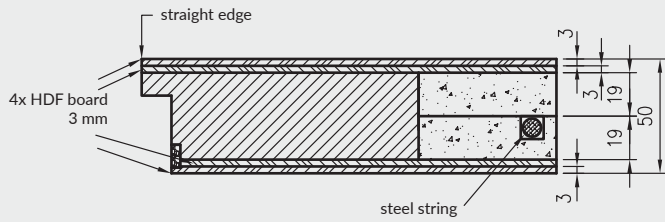

Anti-burglary door leaf Forca B

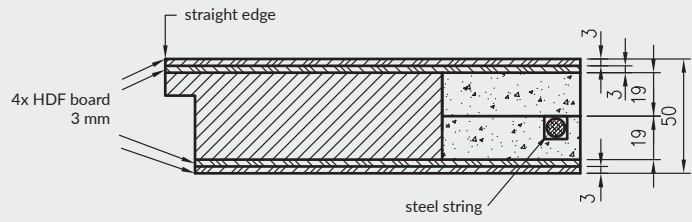

Anti-burglary door leaf SOLID RC2

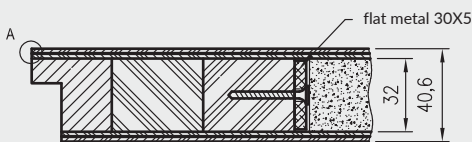

Fire-resistant door leaf Forca EI30

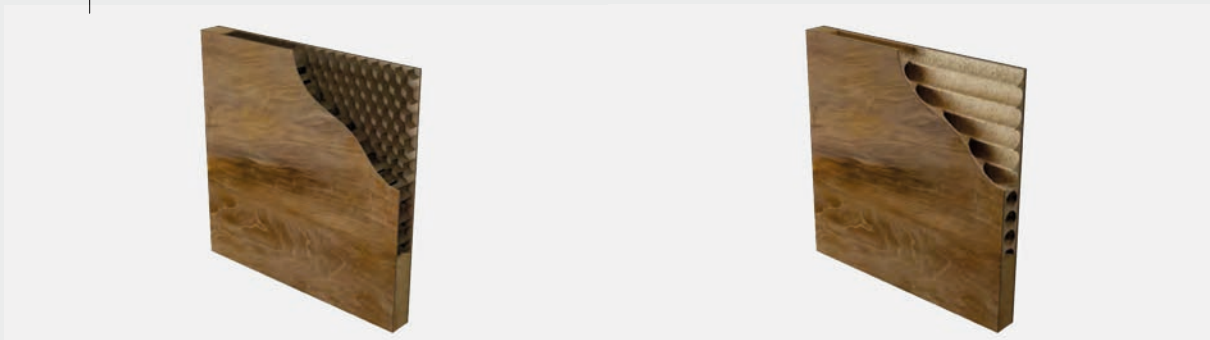
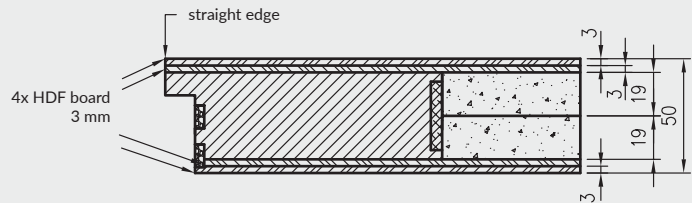

(A) stabilising insert "honeycomb"

(B) perforated chipboard

# TECHNICAL INFORMATIONS

## FRAME CONSTRUCTION DOORS (IS NOT REFERRED TO VETRO A,B,C,D,F)

Frame construction door leaf is entirely made of wood-based panels:

vertical stiles made of wood-based panels - 40 mm

external horizontal stiles made of wood-based panels - 35 mm

horizontal rails (interior):

- wood-based boards - 22 mm in Lumio, Vico, Auri, Piano, Even, Premium, Fosca, Verso, Reva, Solte, Triesta\*, Ena\*, Verano\* door leaves (\* In Ena 1-2, Triesta 1-2 collection, 1-2, Verano 1-2, the frame next to the large glass pane is made of wood-based boards - 35 mm. However, in Ena 3-5, Verano 3-5, 3-5 and Triesta 3 models, there are two stiles next to the large glass panes made of wood-based boards - 35 mm.)

- wood-based panels - 35 mm in Nestor, Elsa, Scala, Berge, Estra door leaves.

Horizontal cross-section of door leaf  
Lumio, Vico, Auri, Verano, Piano, Premium, Fosca,  
Verso, Ena, Even, Triesta, Reva, Solte

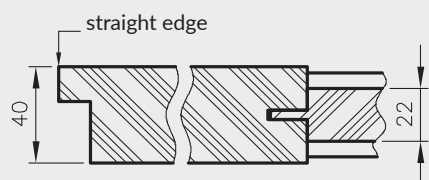

Horizontal cross-section of ELSA

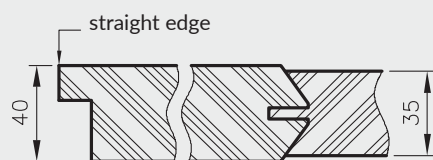

Horizontal cross-section of Ena, Verano and  
Trieste doors (cross-section at the height of  
the rail and stile set by the large glass pane)

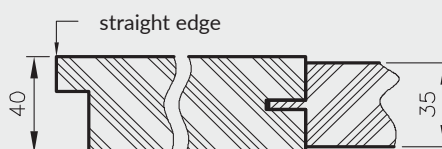

Horizontal cross-section of Nestor

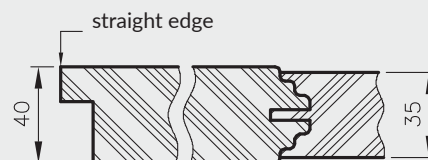

Horizontal cross section of the door leaf Scala, Berge

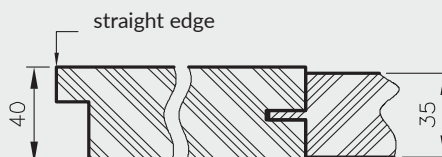

## FILLINGS OF FRAME CONSTRUCTION DOOR LEAF:

Scala A; - 4 mm glass pane, flat 4 mm HDF board

Scala B - 4 mm glass pane, 19 mm MDF profiled board

Elsa A - 4 mm glass pane, flat 4 mm HDF board

Elsa B - 4 mm glass pane, 19 mm MDF profiled board

Premium 1-3 - 4 mm glass pane

Premium 4-7, 12 - 4 mm glass pane, 4 mm HDF marquetrys made in door leaf colour

Premium 8-11, 13 - 4 mm glass pane, 4 mm HDF marquetrys coated with silver laminate

Piano 1-6 - 4 mm glass pane, 16 mm MDF profiled board

Piano 9-12 - 4 mm glass pane, 19 mm MDF profiled board

Fosca 1-3 - 4 mm glass pane, 4 mm HDF board coated with silver laminate

Fosca 4-6 - 4 mm HDF board coated with veneer in door leaf colour

Nestor, Berge - 4 mm glass, 19 mm profiled MDF panel

Ena, Trieste, Auri, Verano, Even, Reva, Solte, Verso - 4 mm glass pane

Estra - 4 mm glass, 16 mm flat MDF panel, undercutted

profile of 19 mm MDF board  
(Scala B, Piano 9-12, Elsa B,  
Nestor, Berge)

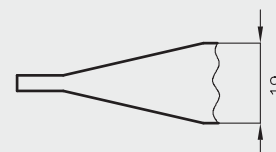

profile of 16 mm MDF  
(Piano 1, 2, 5, 6)

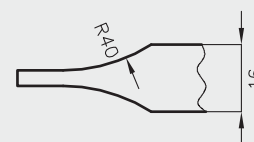



# TECHNICAL INFORMATIONS

## KICK PLATES

Kick plates so called „OKOPNIKI” it is finishing solution for selected panel door models with straight edge. We offer door leaves covered with stainless steel sheets of thickness 0.6 mm in the form of bottom or middle panels. It is also possible to have both panels in the selected door leaf at the same time. The height of the panels is 300 mm. Door leaf with kick plates must be filled with perforated chipboard.

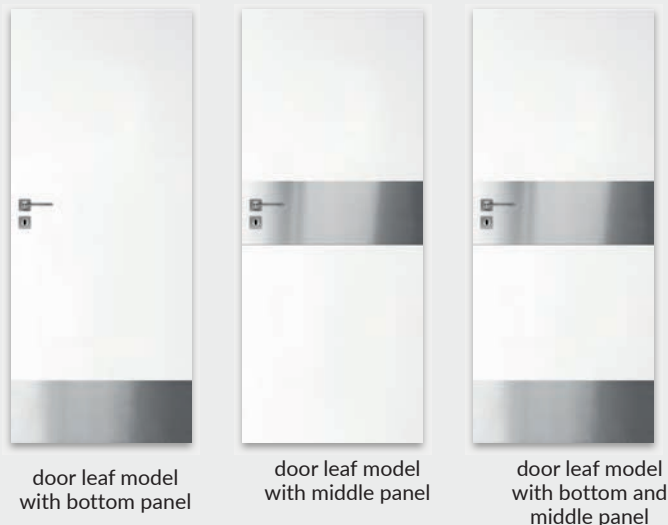

There is possibility to order door leaf with bottom panel and ventilation undercut.

**NOTE:** If you wish to place an order, please contact the Customer Service Department.

## REMAINING TECHNICAL INFORMATIONS:

1. While maintaining the standard dimensions of door leaves and door frames, the gap between the "ready" floor and the lower edge of the door leaf is 8 mm. In order to reduce the above gap, the door frame should be shortened appropriately from the bottom (does not apply to FOLDE and OLIMP).

2. NOTE! Before purchasing and installing construction joinery, check whether the selected type of joinery complies with the requirements of the technical design developed for a given project, and in particular, make sure whether the structure of the walls and ceilings allows the installation of construction joinery with the weight specified in the table below:

	door leaf			Door frames		other products	
	interior	entrance	fire-resistance	adjustable	fixed	Adjustable tunnel	Sliding system
<b>Max weight</b>	50 kg*	50 kg*	105 kg*	40 kg	20 kg	40 kg	20 kg

\* max weight of single leaf door

3. Door leaf is wrapped in shrink film and the edges are additionally protected with Styrofoam or cardboard inserts.

4. Price of door leaf does not include door handles, backplates and cylinders insert (with the exception of SCALA A and B collections in rebated and non-rebated versions in DRE-Cell veneer and 3D veneer also excluding NESTOR and ELSA collections in rebated and non-rebated version in DRE-Cell veneer and 3D veneer, where handle and backplate come).

5. It is possible to purchase CENTRA doors and door frames (without drilling for locks and hinges - option not available for fire resistant doors, ENTER/SOLID, ENTER AKUSTIK, SOLID RC2, FORCA B, Sara Eco 2, FOLDE) for the price of a similar product with fittings and drilling. CENTRA door frames have seals. The set does not include fittings.

## CROSS-SECTIONS OF ALUMINUM FRAMES

DRE profile for non-rebated outward opening doors

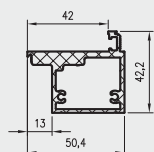

DRE profile for doors with inverted rebate opened inwards

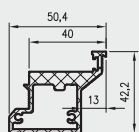

Profile for non-rebated outward opening doors

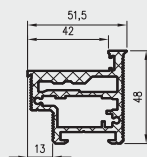

Profile for doors with inverted rebate opened inwards

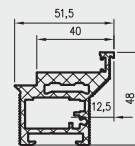

# TECHNICAL INFORMATIONS

6. In accordance with applicable regulations, doors to the bathroom, washroom and a separate toilet should open to the outside of the room, and be at least 0.8 m wide and 2 m high, and have openings in the lower part with a total cross-section of not less than  $0.022\text{m}^2$  for air supply. The ventilation area of the door is the sum of the areas of available ventilation elements: ventilation grille (ensures a ventilation area of  $0.022\text{ m}^2$  in all door widths) or ventilation undercut or ventilation sleeves and the clearance area between the door leaf and the floor.

Ensuring ventilation surface for rebated doors\*\*

Symbol of door leaf dimension	doors with ventilation sleeves		doors with ventilation undercut	
	ventilation surface of sleeves and the clearance 8 mm [m2]	required clearance to meet ventilation requirements [in mm]	ventilation surface of the undercut and the clearance 8 mm [m2]	required clearance to meet ventilation requirements [in mm]
"100"	0,011	19*	0,033	0
"90"	0,010	21*	0,029	1
"80"	0,009	24*	0,025	4
"70"	0,008	28*	0,021	14*
"60"	0,007	33*	0,018	35*

Ensuring ventilation surface for Sara Eco 2 doors and all non-rebated doors

Symbol of door leaf dimension	doors with ventilation sleeves		doors with ventilation undercut	
	ventilation surface of sleeves and the clearance 8 mm [m2]	required clearance to meet ventilation requirements [in mm]	ventilation surface of the undercut and the clearance 8 mm [m2]	required clearance to meet ventilation requirements [in mm]
"100"	0,0112	19*	0,033	0
"90"	0,0104	21*	0,029	1
"80"	0,0096	23*	0,025	4
"70"	0,0082	27*	0,021	12*
"60"	0,0074	32*	0,018	31*

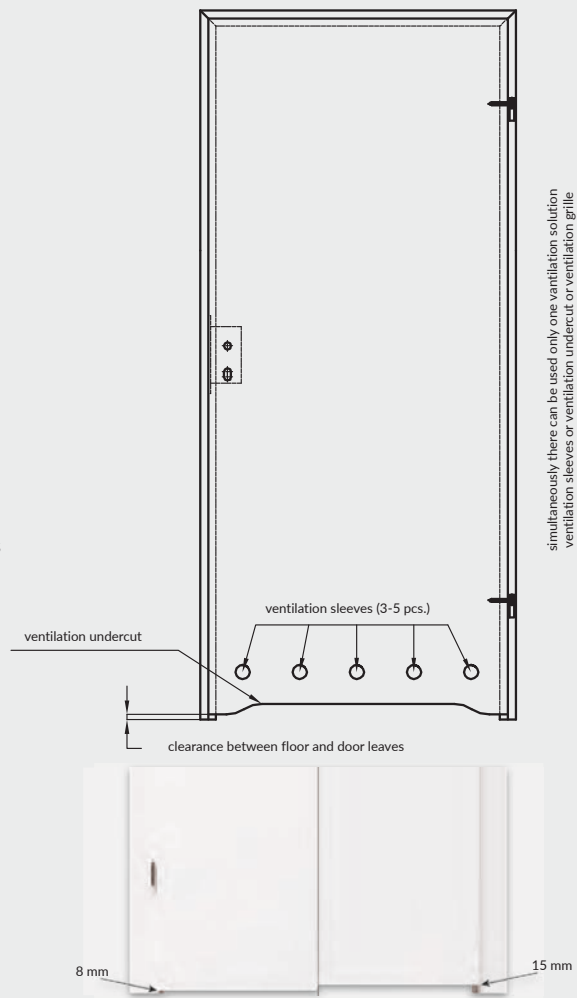

The above - stated required clearance height of the space under the door assures total ventilation surface of  $0.022\text{ m}^2$ . The standard clearance for door leaf is 8mm high.

\* it is necessary to increase the clearance to the specified height by shortening door leaf at the bottom (when such a shortening is possible - see\*\*)

\*\* Exceptions that are not included in the table (door leaf that can not be shortened):

- collection Vetro A, D and E - the use of ventilation undercut in the door with a width of "80" - "100" and a standard ground clearance of the door (8 mm) will fulfill ventilation requirements.
  - Vetro B collection - does not meet the ventilation requirements.
  - sliding door leaf - due to design of the sliding system (distance from the wall/tunnel - about 12 mm), door leaf meet ventilation requirement without need for additional options.
- there is no possibility to shorten double leaf doors and folding doors FOLDE.



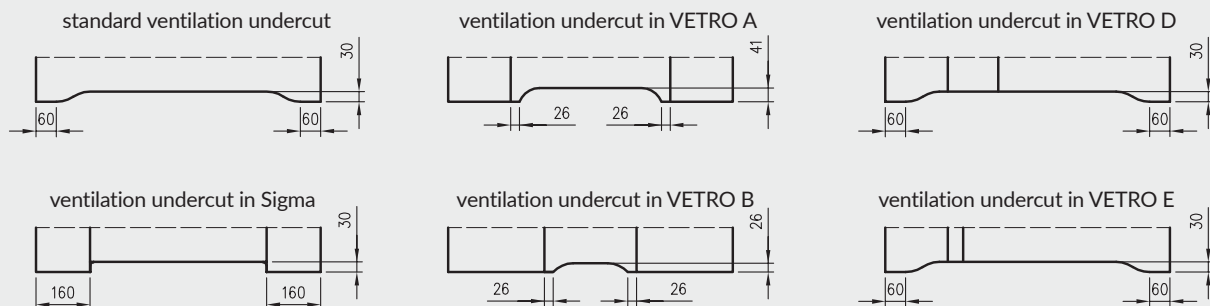



















## VENTILATION UNDERCUT





## GALLA 1 decormat - glass door sliding system

### EXPLANATIONS:

- |  |  |
|--|--|
|  panel doors , DRE - Cell decor             |  panel doors, CPL Laminate                      |
|  frame construction doors, DRE - Cell decor |  entrance doors, CPL Laminate                   |
|  entrance doors, DRE - Cell decor           |  technical doors, CPL Laminate                  |
|  panel doors, 3D decor                      |  glass doors                                    |
|  frame construction doors , 3D decor        |  PROFI panel construction doors                 |
|  entrance doors, 3D decor                   |  panel doors Sara Eco 2                         |
|  panel doors, Finish foil                   |  smoke-proof technical doors                    |
|  panel doors, painted                       |  fire resistant technical doors                 |
|  frame construction doors, painted          |  anti-burglary doors                            |
|  laminated frame construction doors         |  panel construction doors, lacquered            |
|  |  panel construction doors, synchronous laminate |
|  |  frame construction doors, synchronous laminate |

Presented prices of the door leaves doesnt include prices of the door frames and door handles.

The price list is valid from March 1, 2024.

Producer provides 24 months of warranty for door leaf and door frames.

The photos and visualizations used in the catalog show door leaves with a width of 80 cm (does not apply to side pannels). In the case of other door leaf widths, the proportions of the collection pattern, glazing, frames, millings and graphics will change.

More technical informations and informations refered to assembly process are available in product guarantee card.

The folder does not constitute an offer according to the law and is published for information purposes only. The above information is valid starting from the date of this publication. Pursuing a policy of continuous development, we reserve the right to make changes and improvements to the products presented in the folder without prior notice. The colors presented in the catalogue may differ from the actual ones. We reserve the right to make printing errors.

#### Technical approvals:

National Technical Assessment ITB-KOT-2019/0860 issue 1 (sliding system)

National Technical Assessment ITB-KOT-2018/0633 release 2 (FORCA, ATHOS fire doors)

National Technical Assessment ITB-KOT-2022/2051, edition 1 (glass door)

National Technical Assessment ITB-KOT-2021/1945 edition 1 (folding and sliding glass doors)

National Technical Assessment ITB-KOT-2017/0011 edition 2 (ENTER / SOLID / SOLID RC2)

National Technical Assessment ITB-KOT-2018/0407 edition 2 (OLIMP)

PN-EN 14351-2: 2018-E12 (interior doors)

National Technical Assessment ITB-KOT-2019/1132 edition 1 (SARA door leaf)

National Technical Assessment ITB-KOT-2019/0805 edition 1 (steel door frames)



er Day  
I DGA

DYSTRIBUTOR

**DRE**

82-300 Elbląg - Gronowo Górne, ul. Nefrytowa 4  
Headquarters: phone 55 236 42 58  
Customer service department: phone 55 236 42 43 to 48  
fax 55 236 42 51  
Marketing department: phone 55 236 42 40  
working hours: 8:00 - 16:00  
e-mail: dre@dre.pl, eksport@dre.pl www.dre.pl