



DRE

door catalogue

EDITION 2025/1

WORTH KNOWING

TYPES OF VENEERS



FINISH FOILS - basic group of veneers.

3D FOILS - foils with increased durability and excellent aesthetic values, 3D wood structure effect.

DRE-CELL FOILS - premium foils based on polypropylene, which are characterized by rich patterns and colors, while at the same time having high resistance to mechanical damage and guaranteeing high utility values.

ACRYLIC LAMINATES - top quality laminates with a thickness of 0.7 - 0.8 mm with a high degree of gloss or a deep super matt effect.

CPL LAMINATES - CPL laminates with a thickness of 0.15 to 0.7 mm, with the highest quality parameters and resistance to mechanical damage. We recommend for rooms with high traffic.

SYNCHRONOUS LAMINATES - laminated boards that perfectly reproduce the colors and structure of wood. They have excellent technical values and increased resistance to mechanical damage.

VARNISHED DRE PRINT - the digital print on door leaves and door frames is protected with a colourless varnish, thus ensuring the durability of the print against possible damage.

PAINTED - our doors are painted with acrylic varnishes using UV curing technology.

PARAMETERS



FIRE RESISTANCE -
class EI30 or EI60



ACOUSTIC INSULATION
- Rw=32 dB parameter



MECHANICAL RESISTANCE CLASS



SMOKE PROOF



ACOUSTIC INSULATION
- Rw=37 dB parameter



Anti-burglary
- RC2 or RC3 class

SILENT PACKAGE 37dB

- the package includes a dropping seal and a special door leaf insert consisting of a package of acoustic panels. The Silent 37dB package is available in selected panel construction door collections.

REBATED OR NON-REBATED?



NON-REBATED DOORS

Non-rebated doors are flushed with the door frame architraves and create one surface with them. The side surface of the door leaf is free of cutouts on the opening side. Concealed hinges and a magnetic lock complete the minimalist effect.



REBATED DOORS

Rebated doors have a visible cutout in the side edge of the door leaf, where it meets the frame, when opened. In this solution, the hinges are visible on the side on which the door opens.

LEFT OR RIGHT?

LEFT

Left doors have hinges on the left side and the handle on the right.

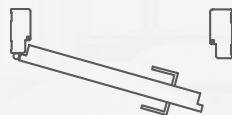

RIGHT

The right door has the hinges on the right side and the handle on the left.



Table of contents

DOORS IN ACRYLIC LAMINATES		
	› ILIS.....	4
	› NELLA.....	6
	› VETRO D2.....	8
	› SILIA.....	10
FRAME CONSTRUCTION DOORS		
N	› Vetro E-Synchro / DRE-Cell.....	14
M	› Estra.....	16
	› Nestor.....	18
M	› Auri.....	20
	› Reva.....	22
M	› Verso.....	24
	› Solte.....	26
	› Fosca.....	28
	› Elsa.....	30
	› Premium.....	32
	› Piano.....	34
	› Scala.....	36
M	› Lumio.....	38
	› Vico.....	40
	› Triesta.....	42
	› Ena.....	44
	› Verano.....	46
	› Vetro A.....	48
	› Vetro B.....	50
	› Vetro D1.....	52
FRAME CONSTRUCTION DOORS PAINTED		
N	› Berge.....	54
N	› Even.....	56
N	› Nestor.....	58
N	› Vetro E.....	60
PANEL CONSTRUCTION DOORS		
	› Nova - Cell.....	64
	› Nova - Synchro.....	66
	› Wood.....	68
	› Grafi.....	70
	› Lux.....	72
	› Rivia.....	74
	› Galeria Alu.....	76
	› Finea and Finea B.....	78
	› Deco.....	80
	› Modern.....	82
	› Plus.....	84
M	› Standard.....	86
	› Fano.....	88
	› Arte.....	90
PANEL CONSTRUCTION DOORS PAINTED		
N	› UNI.....	92
N	› Fargo.....	94
N	› BINITO.....	96
PANEL CONSTRUCTION DOORS CPL LAMINATE		
M	› Standard Invest.....	98
	› Standard CPL.....	100
PANEL CONSTRUCTION DOORS WITH VARIABLE HEIGHTS		
	› Standard 10.....	102
	› Modern.....	82
	› Plus.....	84
DOORS WITH HIDDEN DOOR FRAME		
	› Profi.....	106
N	› SARA ECO 2.....	108
SLIDING AND FOLDING SYSTEMS		
N	› Wall mounted sliding system.....	112
	› Glass doors sliding system.....	113
	› SPAZIO CD wall-mounted sliding system.....	114
	› B01 door frameless cassette.....	115
	› PA door frame cassette (pocket system).....	116
	› Folde.....	118
SIDE PANELS		
	› Panel construction side panels.....	120
	› Frame construction side panels.....	121
TRANSOM LIGHTS AND SIDE LIGHTS		
	› TRANSOM LIGHTS AND SIDE LIGHTS.....	122
INERTRIOR ENTRANCE PANEL CONSTRUCTION DOORS		
	› Enter/Solid.....	126
	› SOLID RC2.....	130
TECHNICAL DOOR LEAVES		
	› Athos fire resistant doors EI30.....	132
	› FORCA anti-burglary doors RC3, fire resistant.....	134
	› Forca B RC3 anti-burglary doors.....	135
	› Fire resistant doors OLIMP EI30 EI 60.....	136
	› Steel door frame, wooden, fire-resistant.....	138
	› Enter Acoustic Rw=32dB.....	139
GLASS DOORS		
N	› Galla.....	140
	› FITTINGS FOR GLASS DOORS.....	141
DOOR FRAMES		
	› fixed rebated door frames.....	144
	› fixed non-rebated door frames.....	145
M	› Adjustable door frames.....	146
	› Adjustable non-rebated door frames.....	148
	› Adjustable rebated door frames with variable heights.....	150
	› Adjustable non-rebated door frames with variable heights.....	151
	› Adjustable door frames with inverted rebate.....	152
	› Adjustable tunnel.....	153
	› Adjustable non-rebated door frames with angle panels.....	154
	› Extension panels.....	156
	› Steel fixed door frame.....	158
	› Steel adjustable door frame.....	161
	› Steel adjustable non-rebated door frame.....	163
	› Steel hybrid door frame.....	164
	› Steel hybrid non-rebated door frame.....	166
	› Small angular steel door frames.....	167
ACCESSORIES, ADDITIONAL INFORMATIONS		
	› Door handles and accessories.....	168
	› Glass panes patterns.....	175
	› Decors.....	176
	› graphic patterns in GRAFI collection.....	178
	› Architraves and skirting boards.....	180
	› Ventilation accessories and other.....	181
TECHNICAL INFORMATIONS		182-195

- N** - New product
- M** - Product available from the stock
- O** - Collection with inverted rebate option

ILIS



ILIS 3 - cubanit



ILIS 3 - bigio

DECORS

STANDARD GLOSS	bianco	magnolia	moro	vino *
METALIC GLOSS	cubanit	gabbiano	bigio	
MATT STANDARD	matt bianco	matt cemento	matt moro	
XTREME MATT	white U1027	anthracite* U1290		

*while stock last



STANDARD OPTIONS

- edge whitout rebate
- door leaf coated with high glossy laminate, standard matt or Xtreme Matt
- stiles and rails made of MDF
- a magnetic/mechanical lock with a simple key, a bathroom lock, a cylinder lock or a economic lock and hinges in black color (for moro and matt moro decors), white color (for bianco, matt bianco and white decors) and steel for other decors.
- glass pane MAT DRE 4 mm thick in ILIS 1-3
- core made of 20 mm MDF board in ILIS 4
- complex safe 8 mm glass pane MAT DRE in ILIS 5
- sockets for 2 recessed Estetic 80 hinges (hinges constitute a part of the door frame)

OPTION WITHOUT EXTRA CHARGE

- glass pane DECORMAT BROWN, DECORMAT GRAPHITE and 4 mm transparent glass in ILIS 1 - 3
- complex safe 8 mm glass pane transparent in ILIS 5
- holes for ventilation sleeves
- sliding door - 2043 mm height

OPTIONS AVAILABLE WITH EXTRA CHARGE

- door leaf „100”
 - ventilation undercut
 - recuperative shortcut -8 mm
 - cover-up strip for double leaf non-rebated door
 - double leaf door door leaf price x2
- NOTE: Third Estetic 80 hinge for non-rebated doors (extra charge is added to the price of the door frame)

ILIS MODELS



ILIS 1



ILIS 2



ILIS 3



ILIS 4



ILIS 5

Sliding system - it is possible to use SPAZIO CD sliding system with a standard door leaf height of 2043 mm.

Gloss laminate. 0.7-0.8 mm of thickness is a modern laminate with a high degree of gloss, giving the effect of a mirror reflection. It is characterized by a perfectly smooth surface with increased scratch resistance.

Xtreme Matt laminate with a thickness of 0.8 mm is an innovative laminate with a matt, non-reflective structure. The Xtreme Matt surface is durable, scratch-resistant and easy to care for. The structure has been additionally reinforced with the Anti-Finger-Print property, which protects the surface fingerprints against and traces of grease.

Matt Standard Laminate with the 0.7-0.8 mm of thickness, the same properties as a high-gloss surface. The only difference is the degree of gloss of the hardcoat layer. Thanks to the pore-free hardcoat coating, the laminate can be used in rooms with the highest hygienic requirements.

NELLA



NELLA 4 - white extreme matt



NELLA 1 - gabbiano

DECORS

STANDARD GLASS	bianco	magnolia	moro	vino *
METALIC GLOSS	cubanit	gabbiano	bigio	
MATT STANDARD	matt bianco	matt cemento	matt moro	
XTREME MATT	white U1027	anthracite* U1290		

*while stock last



NELLA

NELLA

NON-REBATED DOOR LEAVES
interior doors

STANDARD OPTIONS

- edge whitout rebate
- door leaf coated with high glossy laminate, standard matt or Xtreme Matt
- stiles and rails made of MDF
- a magnetic/mechanical lock with a simple key, a bathroom lock, a cylinder lock or a economic lock and hinges in black color (for moro and matt moro decors), white color (for bianco, matt bianco and white decors) and steel for other decors.
- glass pane MAT DRE 4 mm thick
- sockets for 2 recessed Estetic 80 hinges (hinges constitute a part of the door frame)

OPTION WITHOUT EXTRA CHARGE

- glass pane DECORMAT BROWN, DECORMAT GRAPHITE and transparent glass pane
- holes for ventilation sleeves
- sliding door - 2043 mm height

OPTIONS AVAILABLE WITH EXTRA CHARGE

- door leaf „100”
 - ventilation undercut
 - recuperative shortcut -8 mm
 - cover strip for double leaf door
 - double leaf door door leaf price x2
- NOTE: Third Estetic 80 hinge for non-rebated doors (extra charge is added to the price of the door frame)

NELLA MODELS

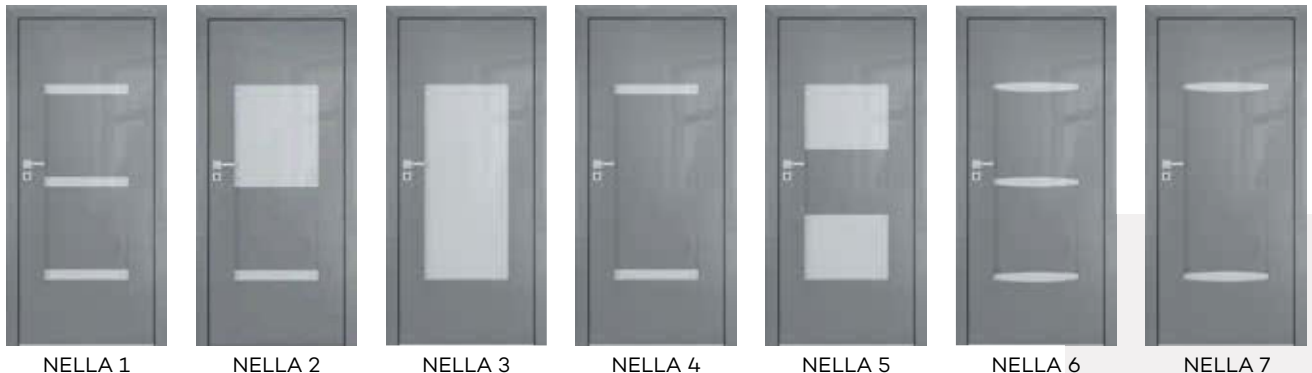

Sliding system - it is possible to use SPAZIO CD sliding system with a standard door leaf height of 2043 mm.

Gloss laminate. 0.7-0.8 mm of thickness is a modern laminate with a high degree of gloss, giving the effect of a mirror reflection. It is characterized by a perfectly smooth surface with increased scratch resistance.

Xtreme Matt laminate with a thickness of 0.8 mm is an innovative laminate with a matt, non-reflective structure. The Xtreme Matt surface is durable, scratch-resistant and easy to care for. The structure has been additionally reinforced with the Anti-Finger-Print property, which protects the surface fingerprints against and traces of grease.

Matt Standard Laminate with the 0,7-0.8 mm of thickness, the same properties as a high-gloss surface. The only difference is the degree of gloss of the hardcoat layer. Thanks to the pore-free hardcoat coating, the laminate can be used in rooms with the highest hygienic requirements.

Width of doors: single-leaf "60" ÷ "100", double-leaf "120" ÷ "180".

Technical information: door frames: pp. 144-167, accessories: pp. 168-174 and 181, door leaves: pp. 182-195.

VETRO D2



VETRO D2 - bigio



VETRO D2 - cubanite

DECORS

STANDARD GLOSS	bianco	magnolia	moro	vino *
METALIC GLOSS	cubanite	gabbiano	bigio	
MATT STANDARD	matt bianco	matt cemento	matt moro	
XTREME MATT	white U1027	anthracite* U1290		

*while stock last

ventilation undercut



VETRO D2

NON-REBATED DOOR LEAVES
interior doors

STANDARD OPTIONS

- edge whitout rebate
- door leaf coated with high glossy laminate, standard matt or Xtreme Matt
- door leaf frame made of MDF, narrow element with constant width, wide element with variable width
- core made of perforated chipboard
- a magnetic lock with a simple key, a toilet lock, a cylinder lock or a magnetic economic lock and hinges in black (for moro and moro matt decors), white (for bianco, bianco matt, white decors) and steel for other decors.
- complex safe MAT DRE 8 mm glass
- sockets for 2 hidden concealed Estetic 80 hinges (non-rebated door frames are equipped with hinges)

OPTION WITHOUT EXTRA CHARGE

- complex safe transparent 8 mm glass pane
- sliding door - 2043 mm height
- 8 mm black laminated glass pane

OPTIONS AVAILABLE WITH EXTRA CHARGE

- door leaf „100“
- ventilation undercut
- cover-up strip for double leaf non-rebated door
- double leaf door door leaf price x2

- **NOTE: third Estetic 80 hinge for non-rebated doors (extra charge is added to the price of the door frame)**
- **NOTE: VETRO D2 sliding door leaves do not fit the sliding system with PA frame cassette.**
- **NOTE: There is no possibility to shorten door leaf.**
- VETRO D2 – meets ventilation requirements for widths "80" - "100" with ventilation undercut

VETRO D2 MODELS



Sliding system - it is possible to use SPAZIO CD sliding system with a standard door leaf height of 2043 mm.

Gloss laminate. 0.7-0.8 mm of thickness is a modern laminate with a high degree of gloss, giving the effect of a mirror reflection. It is characterized by a perfectly smooth surface with increased scratch resistance.

Xtreme Matt laminate with a thickness of 0.8 mm is an innovative laminate with a matt, non-reflective structure. The Xtreme Matt surface is durable, scratch-resistant and easy to care for. The structure has been additionally reinforced with the Anti-Finger-Print property, which protects the surface fingerprints against and traces of grease.

Matt Standard Laminate with the 0.7-0.8 mm of thickness, the same properties as a high-gloss surface. The only difference is the degree of gloss of the hardcoat layer. Thanks to the pore-free hardcoat coating, the laminate can be used in rooms with the highest hygienic requirements.

Width of doors: single-leaf "60" ÷ "100", double-leaf "120" ÷ "180".

Technical information: door frames: pp. 144-167, accessories: pp. 168-174 and 181, door leaves: pp. 182-195.

SILIA



SILIA 10 - cemento matt



DECORS

STANDARD GLOSS	bianco	magnolia	moro	vino *
METALIC GLOSS	cubanit	gabbiano	bigio	
MATT STANDARD	matt bianco	matt cemento	matt moro	
XTREME MATT	white U1027	anthracite* U1290		

*while stock last

Note: the option to choose a patterned edge applies only to doors in the bianco decor.

EDGE BANDING PATTERNS



theme 1

theme 2

theme 3

SILIA steel BULAJ - bigio



STANDARD OPTIONS

- edge whitout rebate
- core made of perforated chipboard
- door leaf coated with high glossy laminate, standard matt or Xtreme Matt
- edge banding in door leaf colour
- a magnetic/mechanical lock with a simple key, a bathroom lock, a cylinder lock or a economic lock and hinges in black color (for moro and matt moro decors), white color (for bianco, matt bianco and white decors) and steel for other decors.
- sockets for 2 hidden recessed Estetic 80 hinges (hinges constitute a part of the door frame)

OPTION WITHOUT EXTRA CHARGE

- holes for ventilation sleeves
- sliding door - 2043 mm height

OPTIONS AVAILABLE WITH EXTRA CHARGE

- edge motif 1, 2 or 3 (only bianco color)
 - door leaf „100”
 - ventilation undercut
 - recuperative shortcut -8mm
 - cover strip for double leaf door
 - aluminum ventilation grille
 - double leaf door
- door leaf price x2
- NOTE: Third Estetic 80 hinge for non-rebated doors (extra charge is added to the price of the door frame)

SILIA MODELS



SILIA 10
bianco

SILIA 10
magnolia

SILIA 10
gabbiano

BULAJ
STEEL
bigio

Steel BULAJ in steel or black colour - available only with matt or transparent glass.

Sliding system - it is possible to use SPAZIO CD sliding system with a standard door leaf height of 2043 mm.

Gloss laminate. 0.7-0.8 mm of thickness is a modern laminate with a high degree of gloss, giving the effect of a mirror reflection. It is characterized by a perfectly smooth surface with increased scratch resistance.

Xtreme Matt laminate with a thickness of 0.8 mm is an innovative laminate with a matt, non-reflective structure. The Xtreme Matt surface is durable, scratch-resistant and easy to care for. The structure has been additionally reinforced with the Anti-Finger-Print property, which protects the surface fingerprints against and traces of grease.

Matt Standard. 0.7 - 0.8 mm thick laminate has the same features as surface of high gloss laminate. Only one difference is degree of the gloss level of hardcoat layer. Features of hardcoat layer, which surface is exactly smooth, allows to be used in rooms with the highest hygienic requirements. .

FRAME CONSTRUCTION DOORS



Frame construction doors are characterized by a modern appearance and excellent durability. In addition, surface finishes with foils, laminates or acrylic varnishes provide durability, ease of care and a wide range of adjustment aesthetic options for interiors.



EVEN 0, 3 - white acrylic UV varnish

VETRO E



VETRO E - natural halifax oak



VETRO E - natural halifax oak

DECORS

LAMINATES EGGER 1st group	gray oak halifax	natural oak halifax	Halifax Tabac Oak				
	white elm	elm natural	elm dark				
	white mat	light gray matt	warm gray matt	cashmere matt	NEW sage matt	dark olive matt	dark blue matt
DRE CELL							black matt 2

ventilation undercut



VETRO E

REBATED AND NON-REBATED DOOR LEAVES

interior doors

STANDARD OPTIONS

- door leaf surface covered with DRE-CELL foil or laminated, 3 mm synchronous board (EGGER laminate) or 4 mm thick (CLEAF laminate)
- reinforced MDF frame
- core made of tubular chipboard
- DECORMAT tempered laminated 8 mm glass pane with fixed width (regardless the width of the door leaf) or laminated black tempered 8 mm glass pane (opaque) with fixed width (regardless the door leaf width)

REBATED DOOR LEAF (1st, 2nd group)

- straight edge in black color
- for natural halifax oak decor, the edge in the color of the door leaf or black
- 3 screw-in hinges
- single-point mortise simple key lock, bathroom lock, cylinder lock or economic lock

NON-REBATED DOOR LEAF

(extra charge 1st, 2nd group)

- black non-rebated edge for laminates from 1st and 2nd group
- edge without rebate in the same color as door leaf color in DRE-CELL foil
- for natural halifax oak decor, the edge in the color of the door leaf or black
- sockets for 2 Estetic 80 recessed hinges in steel, black or white color (hinges constitute a part of the door frame)
- magnetic simple key lock, bathroom lock, cylinder insert lock or economic lock in steel, black or white color

DOOR FRAMES

- for door leaves from the Vetro E collection in synchronous laminates, we recommend door frames in black matt foil 2 and in CPL laminate natural halifax oak in a longitudinal arrangement, in the second CPL price group
- for door leaves from Vetro E collection in DRE-CELL foils, we recommend door frames in the color of the door leaf

OPTIONS AVAILABLE WITH EXTRA CHARGE

- ventilation undercut
- non-rebated door leaves 1st, 2nd group
- black fittings for rebated door leaf

SLIDING DOOR LEAF

- edge whitout rebate
- socket for hook lock and/or for handles

NOTE: sliding VETRO E door leaves do not fit the sliding system with the PA door frame cassette.

NOTE: There is no possibility to shorten door leaf.

NOTE: Third Estetic 80 hinge for non-rebated doors (extra charge is added to the price of the door frame)

VETRO E – meets ventilation requirements for widths "80" - "100" with ventilation undercut

NOTE: It is required to use together with VETRO rebated door leaf model door frames equipped with 3 hinges.

VETRO E MODELS

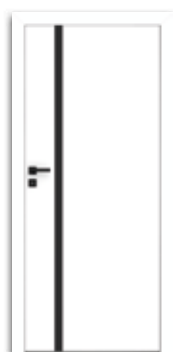

VETRO E
white mat
(black glass pane)



VETRO E
cashmere matt
(DECORMAT glass pane)



VETRO E
warm gray matt
(DECORMAT glass pane)



VETRO E
sage matt
(black glass pane)



VETRO E
dark olive matt
(black glass pane)



VETRO E
dark blue mat
(DECORMAT glass pane)



VETRO E
gray halifax oak



VETRO E
halifax oak
natural



VETRO E
Halifax Tabac Oak



VETRO E
white elm



VETRO E
natural elm



VETRO E
dark elm

Door leaves width: single leaf door "60"÷"100".

Technical information: door frames: pp. 144-167, accessories: pp. 168-174 and 181, door leaves: pp. 182-195.

Estra



ESTRA 13 - cashmere matt

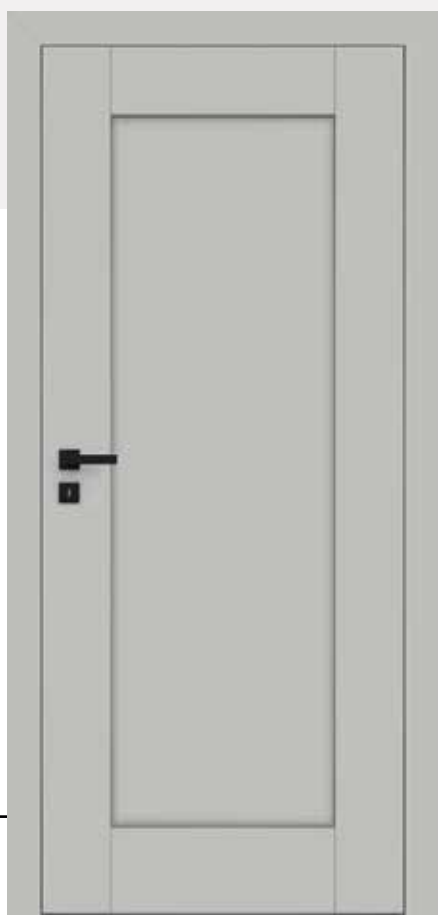

ESTRA 5 - light grey matt

DECORS

DRE CELL	white mat	light gray matt	warm gray matt	cashmere matt	sage oak (textured)	NEW sage matt	dark olive matt
		dark blue matt	black matt 2				
3D	grand oak	elm	american walnut	ebony*	Polish oak 3D		

*while stock last



STANDARD OPTIONS

- stiles made of wood-based panels
- MAT DRE 4 mm glass pane
- 16mm flat panels
- Estra 7-9 models have black glass pane frame and black muntin frame
- Estra 10 model with a mirror
- Estra 12-14 models have a glazing bar in the color of the door leaf

OPTIONS WITHOUT EXTRA CHARGE

- glass pane DECORMAT BROWN, DECORMAT GRAPHITE and transparent glass pane
- holes for ventilation sleeves

REBATED DOOR LEAF

- straight edge
- 3 silver screw-in pivot hinges
- single-point mortise simple key lock, bathroom lock, cylinder lock or economic lock

NON-REBATED OPENING DOOR LEAF

(extra charge)

- edge whitout rebate
- sockets for 2 hidden recessed Estetic 80 hinges (hinges constitute a part of the door frame)
- magnetic/mechanical lock with a simple key, bathroom lock, cylinder lock or economic lock

SLIDING DOOR LEAF

- edge whitout rebate
- socket for hook lock and/or for handles

DOOR LEAF WITH INVERTED REBATE (extra charge)

- active single leaf door
- straight edge
- sockets for two recessed Estetic 1821 hinges (hinges constitute a part of the door frame)
- magnetic simple key lock, bathroom lock, cylinder lock or economic lock

NOTE: The option available only for matt foil decors in the standard height of 2043

OPTIONS AVAILABLE WITH EXTRA CHARGE

- plastic ventilation sleeves 1 pc.
- non-rebated door leaf
- door leaves "90" and "100" standard height 2043
- door leaves "90" and "100" standard height 2110, 2240
- ventilation undercut
- recuperative shortcut -8mm
- door leaf with inverted rebate
- cover strip for double non-rebated door leaf
- black fittings for rebated door leaf
- double leaf door door leaf price x2

NOTE: third Estetic 80 hinge for non-rebated doors (extra charge is added to the price of the door frame)

NOTE: It is required to use door frame equipped with 3 hinges together with rebated door leaf ESTRA .

NOTE: Selected configurations of ESTRA 5 rebated model in matt white are available fromstock.

NOTE: Details and technical drawings of ESTRA 10 model with mirror can be found in the catalogue on page 182 .

ESTRA MODELS



NESTOR



NESTOR 1 - black matt 2



NESTOR 10 - sage oak (structure)

DECORS

DRE CELL	White matt	light gray matt	warm gray matt	cashmere matt	sage oak (textured)	NEW sage matt	dark olive matt
	White pine	siberian elm	elm sand	elm vintage	walnut caramel	anthracite elm	dark wenge
	dark blue matt	black matt 2					
3D	Polish oak 3D						



NESTOR

REBATED, NON-REBATED, WITH INVERTED REBATED DOOR LEAVES

interior doors

STANDARD OPTIONS

- stiles made of wood-based panels
- MAT DRE 4 mm glass pane
- profiled 19mm MDF panels

REBATED DOOR LEAF

- straight edge
- 3 silver screw-in pivot hinges
- single-point mortise simple key lock, bathroom lock, cylinder lock or economic lock

NON-REBATED OPENING DOOR LEAF

(extra charge)

- edge without rebate
- sockets for 2 recessed Estetic 80 hinges (hinges constitute a part of the door frame)
- magnetic/mechanical lock for a simple key, bathroom lock, cylinder lock or economic lock in steel and black color or magnetic in white, gold color - to choose from

SLIDING DOOR LEAF

- edge without rebate
- socket for hook lock and/or for handles

DOOR LEAF WITH INVERTED REBATE (EXTRA CHARGE)

- active single door leaf
- straight edge
- sockets for two recessed Estetic 1821 hinges (hinges constitute a part of the door frame)
- magnetic simple key lock, bathroom lock, cylinder lock or economic lock

NOTE: This option is available only for matt foil decors

OPTIONS WITHOUT EXTRA CHARGE

- glass pane DECORMAT BROWN, DECORMAT GRAPHITE and transparent glass pane
- holes for ventilation sleeves

OPTIONS AVAILABLE WITH EXTRA CHARGE

- plastic ventilation sleeves 1 pc.
- non-rebated door leaf
- door leaf „90" and „100"
- ventilation undercut
- recuperative shortcut -8mm
- door leaf with inverted rebate
- cover strip for double non-rebated door leaf
- black fittings for rebated door leaf
- double leaf door door leaf price x2

NOTE: third Estetic 80 hinge for non-rebated doors (extra charge is added to the price of the door frame)

NOTE: It is required to use together with NESTOR rebated door leaf model door frames equipped with 3 hinges. .

NESTOR MODELS



panel
NESTOR

Door leaf width: single leaf "60" ÷ "100", double leaf rebated "120" ÷ "200", double leaf non-rebated "120" ÷ "180".
Technical information: door frames: pp. 144-167, accessories: pp. 168-174 and 181, door leaves: pp. 182-195.

AURI



AURI 8 - American walnut



AURI 4 - dark olive matt

DECORS

DRE CELL 1st gr.	white (textured)	White matt	White pine	siberian elm	sand oak	bleached oak textured	vintage oak
	NEW natur oak premium	anthracite elm	dark wenge	marrone chestnut textured	evoke oak	walnut caramel	black matt 2
DRE CELL 2nd gr.	light gray matt	warm gray matt	cashmere matt	sage oak (textured)	NEW sage matt	dark olive matt	dark blue matt
	3D	grand oak	elm	american walnut	ebony*	Polish oak 3D	

*while stock last



STANDARD OPTIONS

- stiles made of wood-based panels
- MAT DRE 4 mm glass pane
- flat inserts (AURI 6-8)

REBATED DOOR LEAF

- straight edge
- 3 silver screw-in pivot hinges
- single-point mortise simple key lock, bathroom lock, cylinder lock or economic lock

NON-REBATED OPENING DOOR LEAF

(extra charge)

- edge whitout rebate
- sockets for 2 hidden recessed Estetic 80 hinges (hinges constitute a part of the door frame)
- magnetic simple key lock, bathroom lock, cylinder lock or economic lock

SLIDING DOOR LEAF

- edge whitout rebate
- socket for hook lock and/or for handles

NOTE: There is possibility to make rebated "40" side panels.

It is required to use door frame equipped with 3 hinges together with AURI rebated door leaf model.

OPTIONS WITHOUT EXTRA CHARGE

- glass pane DECORMAT BROWN, DECORMAT GRAPHITE and transparent glass pane
- holes for ventilation sleeves

OPTIONS AVAILABLE WITH EXTRA CHARGE

- plastic ventilation sleeves 1 pc.
- non-rebated door leaf
- door leaf „90" and „100"
- ventilation undercut
- recuperative shortcut -8mm
- cover strip for double non-rebated door leaf
- black VSG 22.1 safety glass
- AURI 0
- auri 1
- AURI 2, 5
- AURI 3
- AURI 4
- AURI 6
- AURI 8
- double leaf door door leaf price x2

NOTE: Third Estetic 80 hinge for non-rebated doors (extra charge is added to the price of the door frame)

NOTE: Selected configurations of AURI 0 rebated model in the evoke oak colour are available from stock.

AURI MODELS



AURI 0

auri 1

auri 2

auri 3

auri 4

auri 5

auri 6

1 glass pane, 4 inserts in the color of the door leaf



auri 7

inserts in the colour of the door leaf

auri 8

2 glass panes, 3 inserts in door leaf colour

REVA



REVA 1 -vintage oak



REVA 1 - American Walnut

DECORS

DRE CELL 1st gr.	white (textured)	White matt	White pine	siberian elm	sand oak	bleached oak textured	vintage oak
	NEW natur oak premium	anthracite elm	dark wenge	marrone chestnut textured	evoke oak	walnut caramel	black matt 2
DRE CELL 2nd gr.	light gray matt	warm gray matt	cashmere matt	sage oak (textured)	NEW sage matt	dark olive matt	dark blue matt
	3D	grand oak	elm	american walnut	ebony*	Polish oak 3D	

*while stock last



REVA

REVA

REBATED, NON-REBATED DOOR LEAVES

interior doors

STANDARD OPTIONS

- stiles made of wood-based panels
- MAT DRE 4 mm glass pane
- flat inserts (REVA 5-7)

REBATED DOOR LEAF

- straight edge
- 3 silver screw-in pivot hinges
- single-point mortise simple key lock, bathroom lock, cylinder lock or economic lock

NON-REBATED OPENING DOOR LEAF

(extra charge)

- edge whitout rebate
- sockets for 2 hidden concealed Estetic 80 hinges (non-rebated door frames are equipped with hinges)
- magnetic/mechanical lock with a simple key, bathroom lock, cylinder lock or economic lock

SLIDING DOOR LEAF

- edge whitout rebate
- socket for hook lock and/or for handles

OPTION WITHOUT ADDITIONAL CHARGE

- glass pane DECORMAT BROWN, DECORMAT GRAPHITE and transparent glass pane
- holes for ventilation sleeves

OPTIONS AVAILABLE WITH EXTRA CHARGE

- plastic ventilation sleeves 1 pc.
- non-rebated door leaf
- door leaf „90” and „100”
- ventilation undercut
- recuperative shortcut -8mm
- cover strip for double non-rebated door leaf
- black VSG 22.1 safety glass
- REVA 1
- REVA 2
- REVA 3,4
- REVA 5
- REVA 7
- black fittings for rebated door leaf
- double leaf door door leaf price x2

NOTE: Third Estetic 80 hinge for non-rebated doors (extra charge is added to the price of the door frame)

NOTE: There is possibility to make rebated "40" side panels.

NOTE: It is required to use door frame equipped with 3 hinges together with REVA rebated door leaf model.

REVA MODELS



REVA 1



REVA 2



REVA 3



REVA 4



REVA 5
1 glass pane, 5
inserts in the colour
of the door leaf



REVA 6
inserts in the color
of the door leaf



REVA 7
2 glass panes, 4
inserts in the color
of the door leaf

Verso



VERSO 0 - white pine



VERSO 3 - white matt

DECORS

DRE CELL	White matt	White pine
----------	---------------	---------------



Verso

Verso

REBATED, NON-REBATED DOOR LEAVES

interior doors

STANDARD OPTIONS

- stiles made of wood-based panels
- MAT DRE 4 mm glass pane

OPTIONS WITHOUT EXTRA CHARGE

- glass pane DECORMAT BROWN, DECORMAT GRAPHITE and transparent glass pane
- holes for ventilation sleeves

REBATED DOOR LEAF

- straight edge
- 3 silver screw-in pivot hinges
- single-point mortise simple key lock, bathroom lock, cylinder lock or economic lock

NON-REBATED OPENING DOOR LEAF

(extra charge)

- edge whitout rebate
- sockets for 2 hidden recessed Estetic 80 hinges (hinges constitute a part of the door frame)
- magnetic/mechanical lock with a simple key, bathroom lock, cylinder lock or economic lock

SLIDING DOOR LEAF

- edge whitout rebate
- socket for hook lock and/or for handles

OPTIONS AVAILABLE WITH EXTRA CHARGE

- plastic ventilation sleeves 1 pc.
- non-rebated door leaf
- door leaf „90" and „100"
- ventilation undercut
- recuperative shortcut -8mm
- cover strip for double non-rebated door leaf
- black fittings for rebated door leaf
- double leaf door door leaf price x2

NOTE: Third Estetic 80 hinge for non-rebated doors (extra charge is added to the price of the door frame)

NOTE: Selected configurations of VERSO O rebated model in white matt are available from stock.

VERSO MODELS

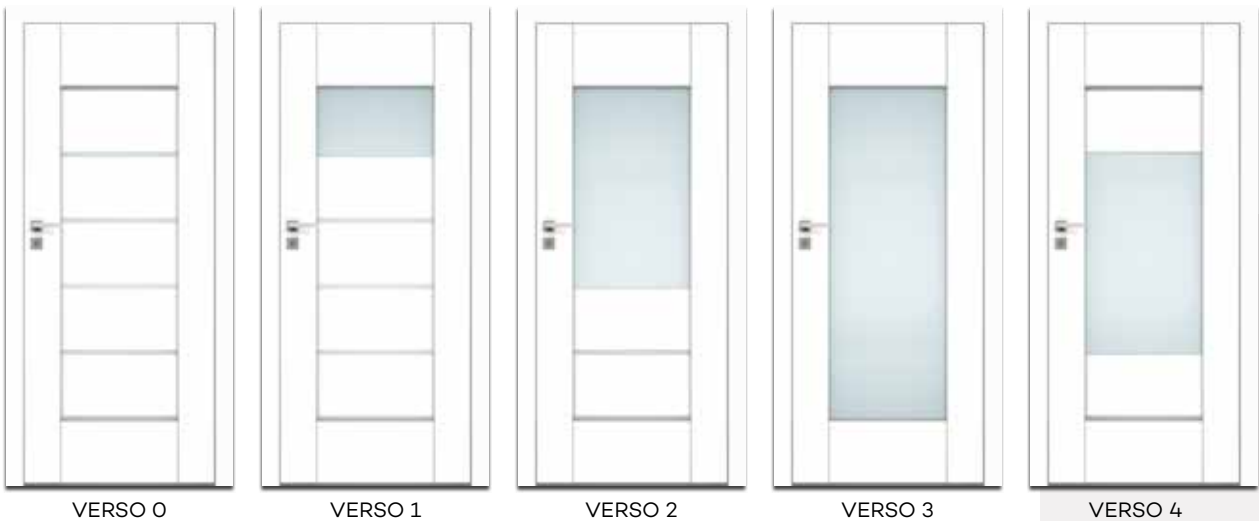

SOLTE



SOLTE 1 - American walnut



SOLTE 1 - Siberian elm

DECORS

DRE CELL	white (textured)	White matt	White pine	siberian elm	sand oak	bleached oak textured	vintage oak
	NEW						
	natur oak premium	anthracite elm	dark wenge	marrone chestnut textured	evoke oak	walnut caramel	light gray matt
		black matt 2					
3D	grand oak	elm	american walnut	ebony*	Polish oak 3D		

*while stock last



STANDARD OPTIONS

- stiles made of wood-based panels
- glass pane MAT DRE 4 mm thick (SOLTE 2 - 3)
- flat panel insert (SOLTE 1 - 2)

OPTIONS WITHOUT EXTRA CHARGE

- glass pane DECORMAT BROWN, DECORMAT GRAPHITE and transparent glass pane
- holes for ventilation sleeves

REBATED DOOR LEAF

- straight edge
- 3 silver screw-in pivot hinges
- single-point mortise simple key lock, bathroom lock, cylinder lock or economic lock

NON-REBATED OPENING DOOR LEAF

(extra charge)

- edge whitout rebate
- sockets for 2 hidden concealed Estetic 80 hinges (non-rebated door frames are equipped with hinges)
- magnetic/mechanical lock with a simple key, bathroom lock, cylinder lock or economic lock

SLIDING DOOR LEAF

- edge whitout rebate
- socket for hook lock and/or for handles

OPTIONS AVAILABLE WITH EXTRA CHARGE

- plastic ventilation sleeves 1 pc.
- non-rebated door leaf
- door leaf „90” and „100”
- ventilation undercut
- recuperative shortcut -8mm
- cover strip for double non-rebated door leaf
- black fittings for rebated door leaf
- double leaf door door leaf price x2

NOTE: Third Estetic 80 hinge for non-rebated doors (extra charge is added to the price of the door frame)

NOTE: There is possibility to make rebated "40" side panels.

NOTE: It is required to use door frame equipped with 3 hinges together with SOLTE rebated door leaf model.

SOLTE MODELS



SOLTE 1



SOLTE 2



SOLTE 3

FOSCA



FOSCA 0 - grand oak



FOSCA 6 - grand oak

DECORS

DRE CELL	white (textured)	White matt	White pine	siberian elm	sand oak	bleached oak textured	vintage oak
	NEW						
	natur oak premium	anthracite elm	dark wenge	marrone chestnut textured	evoked oak	walnut caramel	light gray matt
		black matt 2					
3D	grand oak	elm	american walnut	ebony*	Polish oak 3D		

*while stock last



STANDARD OPTIONS

- stiles made of wood-based panels
- MAT DRE 4 mm glass pane
- flat panel insert coated with silver laminate (FOSCA 1-3) or in door leaf colour (FOSCA 4-6)

OPTION WITHOUT EXTRA CHARGE

- glass pane DECORMAT BROWN, DECORMAT GRAPHITE and transparent glass pane
- holes for ventilation sleeves

REBATED DOOR LEAF

- straight edge
- 3 silver screw-in pivot hinges
- single-point mortise simple key lock, bathroom lock, cylinder lock or economic lock

NON-REBATED OPENING DOOR LEAF

(extra charge)

- edge whitout rebate
- sockets for 2 hidden recessed Estetic 80 hinges (hinges constitute a part of the door frame)
- magnetic simple key lock, bathroom lock, cylinder lock or economic lock

SLIDING SYSTEM DOOR LEAF

- edge whitout rebate
- socket for hook lock and/or for handles

OPTIONS AVAILABLE WITH EXTRA CHARGE

- plastic ventilation sleeves 1 pc.
 - non-rebated door leaf
 - door leaf „90" and „100"
 - ventilation undercut
 - recuperative shortcut -8mm
 - cover strip for double non-rebated door leaf
 - double leaf door door leaf price x2
- NOTE: Third Estetic 80 hinge for non-rebated doors (extra charge is added to the price of the door frame)

NOTE: There is possibility to make rebated „40" side panels.

NOTE: It is required to use door frame equipped with 3 hinges together with FOSCA rebated door leaf model.

FOSCA MODELS



FOSCA 0
5 pcs. of panes



FOSCA 1
3 pcs. of panes,
2 pcs. of HDF panels



FOSCA 2
1 pc. of glass,
4 pcs. of HDF panels



FOSCA 3
5 pcs. of HDF panels



FOSCA 4
3 pcs. of panes,
2 pcs. of HDF panels



FOSCA 5
1 pc. of glass,
4 pcs. of HDF panels



FOSCA 6
5 pcs. of HDF panels



FOSCA 1-3
(4mm HDF insert coated
with silver laminate)



FOSCA 4-6
(4mm HDF insert
coated in door leaf
colour)

ELSA



ELSA A3 and ELSA O - sand oak



ELSA B - anthracite elm

DECORS

DRE CELL	White matt	White pine	elm sand	elm vintage	anthracite elm	dark wenge
3D	Polish oak 3D					

DOOR HANDLE WITH A BACKPLATE

The promotion applies to rebated and non-rebated door leaves from ELSA collection in DRE-Cell veneer and 3D foil. Handle model and finish color to choose from: WEGA, ATRIA, ARCTUS, POLARIS, ORION, ZETA, AVIOR, MIMOSA and ALTAIR handles and a backplate for a simple key or a cylinder insert or a bathroom lock. The promotion lasts while stocks last.



STANDARD OPTIONS

- stiles made of wood-based panels
- MAT DRE 4 mm glass pane
- flat panel insert (ELSA A), profiled 19 mm MDF panels (ELSA B)

OPTIONS WITHOUT EXTRA CHARGE

- glass pane DECORMAT BROWN, DECORMAT GRAPHITE and transparent glass pane
- holes for ventilation sleeves

REBATED DOOR LEAF

- straight edge
- 3 silver screw-in pivot hinges
- single-point mortise simple key lock, bathroom lock, cylinder lock or economic lock

NON-REBATED OPENING DOOR LEAF

(extra charge)

- edge whitout rebate
- sockets for 2 hidden recessed Estetic 80 hinges (hinges constitute a part of the door frame)
- magnetic simple key lock, bathroom lock, cylinder lock or economic lock

SLIDING DOOR LEAF

- edge whitout rebate
- socket for hook lock and/or for handles

OPTIONS AVAILABLE WITH EXTRA CHARGE

- plastic ventilation sleeves 1 pc.
 - non-rebated door leaf
 - door leaf „90” and „100”
 - ventilation undercut
 - recuperative shortcut -8mm
 - cover strip for double non-rebated door leaf
 - double leaf door door leaf price x2
- NOTE: Third Estetic 80 hinge for non-rebated doors (extra charge is added to the price of the door frame)

NOTE: Rebated "40" side panels available.

It is required to use door frame equipped with 3 hinges together with ELSA rebated door leaf model.

ELSA collection is divided into A and B:

A - flat panel insert in door leaf colour

B - 19 mm convex panel insert in door leaf colour



cross-section of
ELSA A



cross-section of
ELSA B

ELSA MODELS



elsa A



elsa A1



elsa a2



elsa a3



elsa a4



elsa b5



elsa b6



elsa b7



ELSA O



ELSA B

PREMIUM



PREMIUM 0, side panel - vintage oak



PREMIUM 0 - bleached oak textured

DECORS

DRE CELL	white (textured)	White matt	White pine	siberian elm	sand oak	bleached oak textured	vintage oak
	NEW						
	natur oak premium	anthracite elm	dark wenge	marrone chestnut textured	evoked oak	walnut caramel	light gray matt
	black matt 2						
3D	grand oak	elm	american walnut	ebony*	Polish oak 3D		

*while stock last



PREMIUM

REBATED, NON-REBATED DOOR LEAVES

interior doors

STANDARD OPTIONS

- stiles made of wood-based panels
- MAT DRE 4 mm glass pane

OPTION WITHOUT EXTRA CHARGE

- glass pane DECORMAT BROWN, DECORMAT GRAPHITE and transparent glass pane
- holes for ventilation sleeves

REBATED DOOR LEAF

- straight edge
- 3 silver screw-in pivot hinges
- single-point mortise simple key lock, bathroom lock, cylinder lock or economic lock

NON-REBATED OPENING DOOR LEAF

(extra charge)

- edge whitout rebate
- sockets for 2 hidden recessed Estetic 80 hinges (hinges constitute a part of the door frame)
- magnetic simple key lock, bathroom lock, cylinder lock or economic lock

SLIDING SYSTEM DOOR LEAF

- edge whitout rebate
- socket for hook lock and/or for handles

NOTE: There is possibility to make rebated „40” side panels.

NOTE: It is required to use door frame equipped with 3 hinges together with PREMIUM rebated door leaf model.

OPTIONS AVAILABLE WITH EXTRA CHARGE

- plastic ventilation sleeves 1 pc.
- non-rebated door leaf
- door leaf „90” and „100”
- ventilation undercut
- recuperative shortcut -8mm
- cover strip for double non-rebated door leaf
- double leaf door door leaf price x2

NOTE: Third Estetic 80 hinge for non-rebated doors (extra charge is added to the price of the door frame)

PREMIUM MODELS



PREMIUM 0
PREMIUM 4*
PREMIUM 8**

premium 1
premium 5*
premium 9**

premium 2
premium 6*
premium 10**

premium 3
premium 7*
premium 11**

premium 12
2 glass panes, 6
inserts in the colour
of the door leaf

premium 13
2 glass panes, 6
inserts coated with
a silver laminate

In PREMIUM 12 and 13 models, from the top edge there are used two glass panes.



PREMIUM 0-3
(4 mm glass pane)



* PREMIUM 4-7, 12
(4 mm HDF inserts in
door leaf colour)



** PREMIUM 8-11, 13
(4mm HDF inserts,
coated with a silver
laminate)

PIANO



PIANO 0 - Polish oak 3D



PIANO 9 - American walnut

DECORS

DRE CELL	white (textured)	White matt	White pine	siberian elm	sand oak	bleached oak textured	vintage oak
	NEW natur oak premium	anthracite elm	dark wenge	marrone chestnut textured	evoked oak	walnut caramel	light gray matt
	black matt 2						
3D	grand oak	elm	american walnut	ebony*	Polish oak 3D		

*while stock last



panel PIANO 9-12



PIANO

PIANO

REBATED, NON-REBATED DOOR LEAVES

interior doors

STANDARD OPTIONS

- stiles made of wood-based panels
- MAT DRE 4 mm glass pane
- filling with convex panel thickness 16 mm (PIANO 1-2, PIANO 5-6) or 19 mm convex panel (PIANO 9-12)

OPTION WITHOUT EXTRA CHARGE

- glass pane DECORMAT BROWN, DECORMAT GRAPHITE and transparent glass pane
- holes for ventilation sleeves

REBATED DOOR LEAF

- straight edge
- 3 silver screw-in pivot hinges
- single-point mortise simple key lock, bathroom lock, cylinder lock or economic lock

NON-REBATED OPENING DOOR LEAF

(extra charge)

- edge whitout rebate
- sockets for 2 hidden concealed Estetic 80 hinges (non-rebated door frames are equipped with hinges)
- magnetic simple key lock, bathroom lock, cylinder lock or economic lock

SLIDING SYSTEM DOOR LEAF

- edge whitout rebate
- socket for hook lock and/or for handles

NOTE: There is possibility to make rebated „40” side panels.

It is required to use door frame equipped with 3 hinges together with PIANO rebated door leaf model.

OPTIONS AVAILABLE WITH EXTRA CHARGE

- plastic ventilation sleeves 1 pc.
- non-rebated door leaf
- door leaf „90” and „100”
- ventilation undercut
- recuperative shortcut -8mm
- cover strip for double non-rebated door leaf
- double leaf door door leaf price x2

NOTE: Third Estetic 80 hinge for non-rebated doors (extra charge is added to the price of the door frame)

PIANO MODELS



PIANO 0



piano 1



piano 2



piano 3



piano 4



piano 5



piano 6



piano 9



piano 10



piano 11



piano 12

Door leaf width: single leaf "60" ÷ "100", double leaf rebated "120" ÷ "200", double leaf non-rebated "120" ÷ "180".
Technical information: door frames: pp. 144-167, accessories: pp. 168-174 and 181, door leaves: pp. 182-195.

scala



SCALA 0, SCALA B2 - white matt



SCALA 0 - sand oak

DECORS

DRE CELL	white (textured)	White matt	White pine	siberian elm	sand oak	bleached oak textured	vintage oak
	NEW						
	natur oak premium	anthracite elm	dark wenge	marrone chestnut textured	evoke oak	walnut caramel	light gray matt
		black matt 2					
3D	grand oak	elm	american walnut	ebony*	Polish oak 3D		

*while stock last

DOOR HANDLE WITH A BACKPLATE

The promotion applies to rebated and non-rebated door leaves from SCALA collection in DRE-Cell veneer and 3D foil. Handle model and finish color to choose from: WEGA, ATRIA, ARCTUS, POLARIS, ORION, ZETA, AVIOR, MIMOSA and ALTAIR handles and a backplate for a simple key or cylinder insert or a bathroom lock. The promotion lasts while stocks last.



STANDARD OPTIONS

- stiles made of wood-based panels
- MAT DRE 4 mm glass pane
- flat panel insert (SCALA A), 19 mm profiled MDF panels (SCALA B)

OPTIONS WITHOUT EXTRA CHARGE

- glass pane DECORMAT BROWN, DECORMAT GRAPHITE and transparent glass pane
- holes for ventilation sleeves

REBATED DOOR LEAF

- straight edge
- 3 silver screw-in pivot hinges
- single-point mortise simple key lock, bathroom lock, cylinder lock or economic lock

NON-REBATED OPENING DOOR LEAF

(extra charge)

- edge whitout rebate
- sockets for 2 hidden concealed Estetic 80 hinges (non-rebated door frames are equipped with hinges)
- magnetic simple key lock, bathroom lock, cylinder lock or economic lock

SLIDING DOOR LEAF

- edge whitout rebate
- socket for hook lock and/or for handles

NOTE: Rebated "40" side panels available.

It is required to use door frame equipped with 3 hinges together with SCALA rebated door leaf model.

OPTIONS AVAILABLE WITH EXTRA CHARGE

- plastic ventilation sleeves 1 pc.
- non-rebated door leaf
- door leaf „90" and „100"
- ventilation undercut
- recuperative shortcut -8mm
- cover strip for double non-rebated door leaf
- double leaf door door leaf price x2

NOTE: Third Estetic 80 hinge for non-rebated doors (extra charge is added to the price of the door frame)



panel SCALA A, A1-A7 panel SCALA B, B1-B7

SCALA MODELS



SCALA A/B

SCALA A1/B1

SCALA A2/B2

SCALA A3/B3

SCALA A4/B4

SCALA A5/B5

SCALA A6/B6



SCALA A7/B7

SCALA O

LUMIO



LUMIO 1 - alpine white



LUMIO 1 - bleached craft oak

DECORS

FINISH	white alpine	bleached craft oak	riviera oak	rustic oak



STANDARD OPTIONS

- stiles made of wood-based panels
- MAT DRE 4 mm glass pane
- flat inserts (LUMIO 7-9)

OPTIONS WITHOUT EXTRA CHARGE

- glass pane DECORMAT BROWN, DECORMAT GRAPHITE and transparent glass pane
- holes for ventilation sleeves
- 4mm HDF flat panel gloss black lacquered in LUMIO 1, 7, 9 models - instead of a glass pane

REBATED DOOR LEAF

- straight edge
- 3 silver screw-in pivot hinges
- a deadbolt/mechanical lock with a simple key, bathroom lock, cylinder lock or economic lock

OPTIONS AVAILABLE WITH EXTRA CHARGE

- plastic ventilation sleeves 1 pc.
- door leaf „90” and „100”
- ventilation undercut
- recuperative shortcut -8mm
- black VSG 22.1 safety glass
- LUMIO 1
- LUMIO 2
- LUMIO 3, 6
- LUMIO 4
- LUMIO 5
- LUMIO 7
- LUMIO 9
- black fittings for rebated door leaf
- double leaf door door leaf price x2

NOTE: 3 hinges door frames should be used with LUMIO rebated door leaves.

NOTE: Selected configurations of LUMIO 1 and LUMIO 9 models are available from stock in the colour alpine white.

LUMIO MODELS



LUMIO 1



LUMIO 2



LUMIO 3



LUMIO 4



LUMIO 5



LUMIO 6



LUMIO 7
1 pc. of pane, 4 pcs. of inserts in the colour of the door leaf



LUMIO 8
inserts in the door leaf color



LUMIO 9
2 pcs. of panes, 3 pcs. of inserts in the colour of the door leaf

VICO



VICO 7 - riviera oak



VICO 4 - riviera oak

DECORS

FINISH	alpine white	bleached craft oak	riviera oak	rustic oak
---------------	--------------	--------------------	-------------	------------



STANDARD OPTIONS

- stiles made of wood-based panels
- MAT DRE 4 mm glass pane
- flat inserts (VICO 5-7)

OPTIONS WITHOUT EXTRA CHARGE

- glass pane DECORMAT BROWN, DECORMAT GRAPHITE and transparent glass pane
- holes for ventilation sleeves
- 4mm HDF flat panel gloss black lacquered in VICO 1, 5, 7 models - instead of a glass pane

REBATED DOOR LEAF

- straight edge
- 3 silver screw-in pivot hinges
- a deadbolt/mechanical lock with a simple key, bathroom lock, cylinder lock or economic lock

OPTIONS AVAILABLE WITH EXTRA CHARGE

- plastic ventilation sleeves 1 pc.
- door leaf „90” and „100”
- ventilation undercut
- recuperative shortcut -8mm
- black VSG 22.1 safety glass
- VICO 1
- VICO 2
- VICO 3.4
- VICO 5
- VICO 7
- black fittings for rebated door leaf
- double leaf door door leaf price x2

NOTE: 3 hinges door frames should be used with rebated door leaves VICO .

VICO MODELS



VICO 1



VICO 2



VICO 3



VICO 4



VICO 5
1 glass pane, 5
inserts in the colour
of the door leaf



VICO 6
inserts in the colour
of the door leaf



VICO 7
2 pcs. of panes, 4 pcs.
of inserts in the colo-
ur of the door leaf

TRIESTA



TRIESTA 2 - Siberian elm



TRIESTA 0 - evoke oak

DECORS

DRE CELL	white (textured)	White pine	siberian elm	sand oak	bleached oak textured	vintage oak
	anthracite elm	dark wenge	marrone chestnut textured	evoke oak	walnut caramel	



TRIESTA TRIESTA

REBATED, NON-REBATED DOOR LEAVES

interior doors

STANDARD OPTIONS

- stiles made of wood-based panels
- MAT DRE 4 mm glass pane

REBATED DOOR LEAF

- straight edge
- 3 silver screw-in pivot hinges
- single-point mortise simple key lock, bathroom lock, cylinder lock or economic lock

NON-REBATED OPENING DOOR LEAF

(extra charge)

- edge whitout rebate
- sockets for 2 hidden concealed Estetic 80 hinges (non-rebated door frames are equipped with hinges)
- magnetic simple key lock, bathroom lock, cylinder lock or economic lock

SLIDING DOOR LEAF

- edge whitout rebate
- socket for hook lock and/or for handles

OPTION WITHOUT ADDITIONAL CHARGE

- glass pane DECORMAT BROWN, DECORMAT GRAPHITE and transparent glass pane
- holes for ventilation sleeves

OPTIONS AVAILABLE WITH EXTRA CHARGE

- plastic ventilation sleeves 1 pc.
- non-rebated door leaf
- door leaf „90" and „100"
- ventilation undercut
- recuperative shortcut -8mm
- cover strip for double non-rebated door leaf
- double leaf door door leaf price x2

NOTE: Third Estetic 80 hinge for non-rebated doors (extra charge is added to the price of the door frame)

NOTE: For TRIESTA rebated door leaves, door frames with 3 hinges should be used.

TRIESTA MODELS



TRIESTA 0



triesta 1



triesta 2



triesta 3

ENA



ENA 1, ENA 4 - sand oak



ENA 0 - vintage oak

DECORS

DRE CELL	white (textured)	White matt	White pine	siberian elm	sand oak	bleached oak textured	vintage oak
	black matt 2	anthracite elm	dark wenge	marrone chestnut textured	evoke oak	walnut caramel	light gray matt
3D	grand oak	elm	american walnut	ebony*	Polish oak 3D		

*while stock last



STANDARD OPTIONS

- stiles made of wood-based panels
- MAT DRE 4 mm glass pane

OPTIONS WITHOUT EXTRA CHARGE

- glass pane DECORMAT BROWN, DECORMAT GRAPHITE and transparent glass pane
- holes for ventilation sleeves

REBATED DOOR LEAF

- straight edge
- 3 silver screw-in pivot hinges
- single-point mortise simple key lock, bathroom lock, cylinder lock or economic lock

NON-REBATED OPENING DOOR LEAF

(extra charge)

- edge whitout rebate
- sockets for 2 hidden recessed Estetic 80 hinges (hinges constitute a part of the door frame)
- magnetic simple key lock, bathroom lock, cylinder lock or economic lock

SLIDING DOOR LEAF

- edge whitout rebate
- socket for hook lock and/or for handles

OPTIONS AVAILABLE WITH EXTRA CHARGE

- plastic ventilation sleeves 1 pc.
- non-rebated door leaf
- door leaf „90” and „100”
- ventilation undercut
- recuperative shortcut -8mm
- cover strip for double non-rebated door leaf
- double leaf door door leaf price x2

NOTE: Third Estetic 80 hinge for non-rebated doors (extra charge is added to the price of the door frame)

NOTE: It is required to use door frames equipped with 3 hinges together with ENA rebated door leaf model .

ENA MODELS



ENA 0



ena 1



ena 2



ena 3



ena 4



ena 5

VERANO



VERANO 1 - maroon chestnut



VERANO 0 - marrone chestnut textured

DECORS

DRE CELL	white (textured)	White pine	siberian elm	sand oak	bleached oak textured	vintage oak
	anthracite elm	dark wenge	marrone chestnut textured	evoke oak	walnut caramel	



The price of the door leaf does not include the price of the door frame and handle.

VERANO

REBATED, NON-REBATED DOOR LEAVES

interior doors

STANDARD OPTIONS

- stiles made of wood-based panels
- MAT DRE 4 mm glass pane

REBATED DOOR LEAF

- straight edge
- 3 silver screw-in pivot hinges
- single-point mortise simple key lock, bathroom lock, cylinder lock or economic lock

NON-REBATED OPENING DOOR LEAF

(extra charge)

- edge whitout rebate
- sockets for 2 hidden recessed Estetic 80 hinges (hinges constitute a part of the door frame)
- magnetic simple key lock, bathroom lock, cylinder lock or economic lock

SLIDING DOOR LEAF

- edge whitout rebate
- socket for hook lock and/or for handles

OPTION WITHOUT ADDITIONAL CHARGE

- glass pane DECORMAT BROWN, DECORMAT GRAPHITE and transparent glass pane
- holes for ventilation sleeves

OPTIONS AVAILABLE WITH EXTRA CHARGE

- plastic ventilation sleeves 1 pc.
- non-rebated door leaf
- door leaf „90" and „100"
- ventilation undercut
- recuperative shortcut -8mm
- cover strip for double non-rebated door leaf
- double leaf door door leaf price x2

NOTE: Third Estetic 80 hinge for non-rebated doors (extra charge is added to the price of the door frame)

NOTE: It is required to use door frame equipped with 3 hinges together with VERANO rebated door leaf model ..

VERANO MODELS



VERANO 0



verano 1



verano 2



verano 3



verano 4



verano 5

Vetro A



VETRO A1 - dark wenge



VETRO A3 - marrone chestnut textured

DECORS

DRE CELL	white (textured)	White matt	White pine	siberian elm	sand oak	bleached oak textured	vintage oak
	NEW						
	natur oak premium	anthracite elm	dark wenge	marrone chestnut textured	evoke oak	walnut caramel	toffee oak* ***
	black matt 2	light gray matt					
3D	grand oak	elm	american walnut	ebony*	Polish oak 3D		

***decor only in horizontal grain, *decor available while stocks last

ventilation undercut (A)



Vetro A

Vetro A

REBATED, NON-REBATED DOOR LEAVES

interior doors

STANDARD OPTIONS

- reinforced MDF frame
- core made of tubular chipboard
- 8 mm tempered glass

OPTIONS WITHOUT EXTRA CHARGE

- there is possibility to make ventilation undercut (A)
- door leaf with revers positioning of glass pane
- VETRO A1 four possible types of glass pane: DECORMAT, DECORMAT BROWN, DECORMAT GRAPHITE and transparent glass

REBATED DOOR LEAF

- R5 edge
- 3 silver screw-in pivot hinges
- single-point mortise simple key lock, bathroom lock, cylinder lock or economic lock

NON-REBATED OPENING DOOR LEAF

(extra charge) - ONLY WHITE MATT

- edge whitout rebate
- sockets for 2 hidden recessed Estetic 80 hinges (hinges constitute a part of the door frame)
- magnetic simple key lock, bathroom lock, cylinder lock or economic lock

NOTE: Third Estetic 80 hinge for non-rebated doors (extra charge is added to the price of the door frame)

SLIDING DOOR LEAF

- edge whitout rebate
- socket for hook lock and/or for handles

NOTE: Door leaf VETRO A in sliding version is not complementary product to sliding system hidden in the wall PA.

NOTE: There is no possibility to shorten door leaf.

NOTE: It is required to use door frame equipped with 3 hinges together with VETRO rebated door leaf model.

VETRO A - "80"- "100"- with ventilation undercut meets ventilation requirements.

VETRO A MODELS



VETRO A1



VETRO a3



VETRO a4



VETRO a5

Width of door leaf: single-leaf "60"- "100"

Technical information: door frames: pp. 144-167, accessories: pp. 168-174 and 181, door leaves: pp. 182-195.

Vetro B



VETRO B1 - evoke oak



VETRO B1 - vintage oak

DECORS

DRE CELL	white (textured)	White matt	White pine	siberian elm	sand oak	bleached oak textured	vintage oak
	NEW						
	natur oak premium	anthracite elm	dark wenge	marrone chestnut textured	evoke oak	walnut caramel	toffee oak* ***
	black matt 2	light gray matt					
3D	grand oak	elm	american walnut	ebony*	Polish oak 3D		

***decor only in horizontal grain, *decor available while stocks last

ventilation undercut (B)



VETRO B - doesn't fulfill ventilation requirements



Vetro B

Vetro B

REBATED, NON-REBATED DOOR LEAVES

interior doors

STANDARD OPTIONS

- reinforced MDF frame
- core made of tubular chipboard
- 8 mm tempered glass

OPTIONS WITHOUT EXTRA CHARGE

- there is possibility to make ventilation undercut (B)
- door leaf with revers positioning of glass pane
- VETRO B1 four possible types of glass pane: DECORMAT, DECORMAT BROWN, DECORMAT GRAPHITE and transparent glass

REBATED DOOR LEAF

- R5 edge
- 3 silver screw-in pivot hinges
- single-point mortise simple key lock, bathroom lock, cylinder lock or economic lock

NON-REBATED OPENING DOOR LEAF

(extra charge) - ONLY WHITE MATT

- edge whitout rebate
- sockets for 2 hidden recessed Estetic 80 hinges (hinges constitute a part of the door frame)
- magnetic simple key lock, bathroom lock, cylinder lock or economic lock

NOTE: Third Estetic 80 hinge for non-rebated doors (extra charge is added to the price of the door frame)

SLIDING DOOR LEAF

- edge whitout rebate
- socket for hook lock and/or for handles

NOTE: VETRO B door leaves with a width of "70" do not fit the sliding system with a PA frame cassette.

NOTE: There is no possibility to shorten door leaf.

NOTE: It is required to use door frame equipped with 3 hinges together with VETRO rebated door leaf model.

VETRO B - does not meet ventilation requirements.

VETRO B MODELS



VETRO B1



VETRO B3



VETRO B4



VETRO B5

Width of door leaves: single leaf "70"- "100"

Technical information: door frames: pp. 144-167, accessories: pp. 168-174 and 181, door leaves: pp. 182-195.

VETRO D1



VETRO D1 - anthracite elm



VETRO D1 - grand oak

DECORS

DRE CELL	white (textured)	White matt	White pine	siberian elm	sand oak	bleached oak textured	vintage oak
	NEW natur oak premium	anthracite elm	dark wenge	marrone chestnut textured	evoke oak	walnut caramel	toffee oak* ***
	black matt 2	light gray matt					
3D	grand oak	elm	american walnut	ebony*	Polish oak 3D		

***decor only in horizontal grain, *decor available while stocks last

ventilation undercut



VETRO D1

REBATED, NON-REBATED DOOR LEAVES
interior doors

STANDARD OPTIONS

- reinforced MDF frame: narrow element with fixed width, wide element with variable width
- core made of tubular chipboard
- 8 mm tempered glass with fixed width, (regardless of the door leaf width)

OPTIONS WITHOUT EXTRA CHARGE

- door leaf with revers positioning of glass pane

OPTIONS AVAILABLE WITH EXTRA CHARGE

- ventilation undercut
- black tempered laminated glass pane

REBATED DOOR LEAF

- R5 edge
- 3 silver screw-in pivot hinges
- single-point mortise simple key lock, bathroom lock, cylinder lock or economic lock

NON-REBATED OPENING DOOR LEAF

(extra charge) ONLY WHITE MATT

- edge whitout rebate
- sockets for 2 hidden concealed Estetic 80 hinges (non-rebated door frames are equipped with hinges)
- magnetic simple key lock, bathroom lock, cylinder lock or economic lock
- non-rebated door leaf

NOTE: Third Estetic 80 hinge for non-rebated doors (extra charge is added to the price of the door frame)

SLIDING DOOR LEAF

- edge whitout rebate
- socket for hook lock and/or for handles

NOTE: Door leaf VETRO D in sliding version is not complementary product to sliding system hidden in the wall PA.

NOTE: There is no possibility to shorten door leaf.

VETRO D – meets ventilation requirements for widths "80" - "100" with ventilation undercut.

NOTE: It is required to use door frame equipped with 3 hinges together with VETRO rebated door leaf model.

VETRO D1 MODELS



VETRO D1
transparent glass



VETRO D1
decormat



VETRO D1
decormat brown



VETRO D1
decormat graphite

Berge

Berg



BERGE 6 - white



BERGE 5 - ashen

DECORS

PAINTED	white	NEW cashmere	NEW sabio	latte	ashen
---------	-------	-----------------	--------------	-------	-------

white - UV acrylic varnish - RAL 9003
cashmere - NCS S1502-Y50R
sabio - NCS S3005-G80Y
latte - Flugger 4362, NCS S1505-Y50R
ashen - RAL 7035



STANDARD OPTIONS

- door leaf painted with acrylic UV varnish
- stiles made of wood-based panels
- MAT DRE 4 mm glass pane
- profiled 19mm MDF panels

OPTIONS WITHOUT EXTRA CHARGE

- glass pane DECORMAT BROWN, DECORMAT GRAPHITE and transparent glass pane
- holes for ventilation sleeves

REBATED DOOR LEAF

- straight edge
- 3 silver screw-in pivot hinges
- single-point mortise simple key lock, bathroom lock, cylinder lock or economic lock

NON-REBATED OPENING DOOR LEAF

(extra charge)

- edge whitout rebate
- sockets for 2 hidden concealed Estetic 80 hinges (non-rebated door frames are equipped with hinges)
- magnetic/mechanical lock for simple key, bathroom lock, cylinder lock or economic lock in steel and black color or magnetic in white color - to choose from

SLIDING DOOR LEAF

- edge whitout rebate
- socket for hook lock and/or for handles

OPTIONS AVAILABLE WITH EXTRA CHARGE

- plastic ventilation sleeves 1 pc.
- non-rebated door leaf
- door leaf „90” and „100”
- ventilation undercut
- recuperative shortcut -8mm
- cover strip for double non-rebated door leaf
- black fittings for rebated door leaf
- double leaf door door leaf price x2

NOTE: It is required to use door frame equipped with 3 hinges together with BERGE rebated door leaf model .

NOTE: Third Estetic 80 hinge for non-rebated doors (extra charge is added to the price of the door frame)

To ensure the highest quality of painted products, before painting process, both, door leaf and door frames are coated with special material which constitutes solid base.

BERGE MODELS



EVEN



EVEN 0 - white



EVEN 2 - latte



DECORS

PAINTED	white	NEW cashmere	NEW sabio	latte	ashen
---------	-------	-----------------	--------------	-------	-------

white - UV acrylic varnish - RAL 9003
cashmere - NCS S1502-Y50R
sabio - NCS S3005-G80Y
latte - Flugger 4362, NCS S1505-Y50R
ashen - RAL 7035

EVEN

EVEN

REBATED AND NON-REBATED DOOR LEAVES

interior doors

STANDARD OPTIONS

- door leaf painted with acrylic UV varnish
- stiles made of wood-based panels
- MAT DRE 4 mm glass pane

OPTIONS WITHOUT EXTRA CHARGE

- glass pane DECORMAT BROWN, DECORMAT GRAPHITE and transparent glass pane
- holes for ventilation sleeves

REBATED DOOR LEAF

- straight edge
- 3 silver screw-in pivot hinges
- single-point mortise simple key lock, bathroom lock, cylinder lock or economic lock

NON-REBATED OPENING DOOR LEAF

(extra charge)

- edge whitout rebate
- sockets for 2 hidden concealed Estetic 80 hinges (non-rebated door frames are equipped with hinges)
- magnetic simple key lock, bathroom lock, cylinder insert lock or economic lock in steel, black or white color

SLIDING DOOR LEAF

- edge whitout rebate
- socket for hook lock and/or for handles

OPTIONS AVAILABLE WITH EXTRA CHARGE

- plastic ventilation sleeves 1 pc.
- non-rebated door leaf
- door leaf „90” and „100”
- ventilation undercut
- recuperative shortcut -8mm
- cover strip for double non-rebated door leaf
- double leaf door door leaf price x2

NOTE: Third Estetic 80 hinge for non-rebated doors (extra charge is added to the price of the door frame)

NOTE: It is required to use together with rebated door leaf door frames equipped with 3 hinges.

To ensure the highest quality of painted products, before painting process, both, door leaf and door frames are coated with special material which constitutes solid base.

EVEN MODELS



EVEN 0

even 1

even 2

even 3

even 4

even 5

2 glass panes, 4 inserts in the color of the door leaf

even 6

inserts in the colour of the door leaf

NESTOR



NESTOR 12 - white



NESTOR 10 - white

DECORS

		NEW	NEW		
PAINTED	white	cashmere	sabio	latte	ashen

white - UV acrylic varnish - RAL 9003
cashmere - NCS S1502-Y50R
sabio - NCS S3005-G80Y
latte - Flugger 4362, NCS S1505-Y50R
ashen - RAL 7035



NESTOR

REBATED AND NON-REBATED DOOR LEAVES, WITH INVERTED REBATED

interior doors

STANDARD OPTIONS

- door leaf painted with acrylic UV varnish
- stiles made of wood-based panels
- MAT DRE 4 mm glass pane
- profiled 19mm MDF panels

OPTIONS WITHOUT EXTRA CHARGE

- glass pane DECORMAT BROWN, DECORMAT GRAPHITE and transparent glass pane
- holes for ventilation sleeves

REBATED DOOR LEAF

- straight edge
- 3 silver screw-in pivot hinges
- single-point mortise simple key lock, bathroom lock, cylinder lock or economic lock

NON-REBATED OPENING DOOR LEAF

(extra charge)

- edge whitout rebate
- sockets for 2 hidden concealed Estetic 80 hinges (non-rebated door frames are equipped with hinges)
- magnetic/mechanical lock for a simple key, bathroom lock, cylinder lock or economic lock in steel and black color or magnetic in white, gold color - to choose from

SLIDING DOOR LEAF

- edge whitout rebate
- socket for hook lock and/or for handles

DOOR LEAF WITH INVERTED REBATE

(extra charge)

- active single door leaf
- straight edge
- sockets for two recessed Estetic 1821 hinges (hinges constitute a part of the door frame)
- magnetic simple key lock, bathroom lock, cylinder lock or economic lock

OPTIONS AVAILABLE WITH EXTRA CHARGE

- plastic ventilation sleeves 1 pc.
- non-rebated door leaf
- door leaf „90" and „100"
- ventilation undercut
- recuperative shortcut -8mm
- door leaf with inverted rebate
- cover strip for double non-rebated door leaf
- black fittings for rebated door leaf
- double leaf door door leaf price x2

NOTE: third Estetic 80 hinge for non-rebated doors (extra charge is added to the price of the door frame)

NOTE: It is required to use together with NESTOR rebated door leaf model door frames equipped with 3 hinges.

To ensure the highest quality of painted products, before painting process, both, door leaf and door frames are coated with special material which constitutes solid base.

NESTOR MODELS



Door leaf width: single leaf "60" ÷ "100", double leaf rebated "120" ÷ "200", double leaf non-rebated "120" ÷ "180".
 Technical information: door frames: pp. 144-167, accessories: pp. 168-174 and 181, door leaves: pp. 182-195.

VETRO E



VETRO E - latte



VETRO E - sabio, black laminated glass

DECORS

		NEW	NEW		
PAINTED	white	cashmere	sabio	latte	ashen

white - UV acrylic varnish - RAL 9003
cashmere - NCS S1502-Y50R
sabio - NCS S3005-G80Y
latte - Flugger 4362, NCS S1505-Y50R
ashen - RAL 7035



VETRO E

REBATED AND NON-REBATED DOOR LEAVES

interior doors

STANDARD OPTIONS

- door leaf painted with acrylic UV varnish
- reinforced MDF frame: narrow element with fixed width, wide element with variable width
- core made of tubular chipboard
- DECORMAT tempered laminated 8 mm glass pane with fixed width (regardless the width of the door leaf) or laminated black tempered 8 mm glass pane (opaque) with fixed width (regardless the door leaf width)

REBATED DOOR LEAF

- straight edge
- 3 silver screw-in pivot hinges
- single-point mortise simple key lock, bathroom lock, cylinder lock or economic lock

NON-REBATED DOOR LEAF

(extra charge)

- edge whitout rebate
- sockets for 2 hidden concealed Estetic 80 hinges (non-rebated door frames are equipped with hinges)
- magnetic simple key lock, bathroom lock, cylinder insert lock or economic lock in steel, black or white color

SLIDING DOOR LEAF

- edge whitout rebate
- socket for hook lock and/or for handles

OPTIONS AVAILABLE WITH EXTRA CHARGE

- ventilation undercut
 - non-rebated door leaf
 - black fittings for rebated door leaf
- NOTE: Third Estetic 80 hinge for non-rebated doors (extra charge is added to the price of the door frame)

NOTE: sliding VETRO E door leaves do not fit the sliding system with the PA door frame cassette.

NOTE: There is no possibility to shorten door leaf.

VETRO E – meets ventilation requirements for widths "80" - "100" with ventilation undercut

NOTE: It is required to use together with VETRO rebated door leaf model door frames equipped with 3 hinges.

To ensure the highest quality of painted products, before painting process, both, door leaf and door frames are coated with special material which constitutes solid base.

VETRO E MODELS

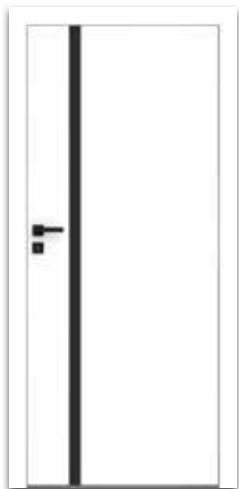

VETRO E
white (black glass)



VETRO E
cashmere (black glass)



VETRO E
sabio (black glass)



VETRO E
latte (DECORMAT glass)



VETRO E
ashen (DECORMAT glass)

Width of door leaf: single-leaf "60"- "100"

Technical information: door frames: pp. 144-167, accessories: pp. 168-174 and 181, door leaves: pp. 182-195.

PANEL CONSTRUCTION DOORS

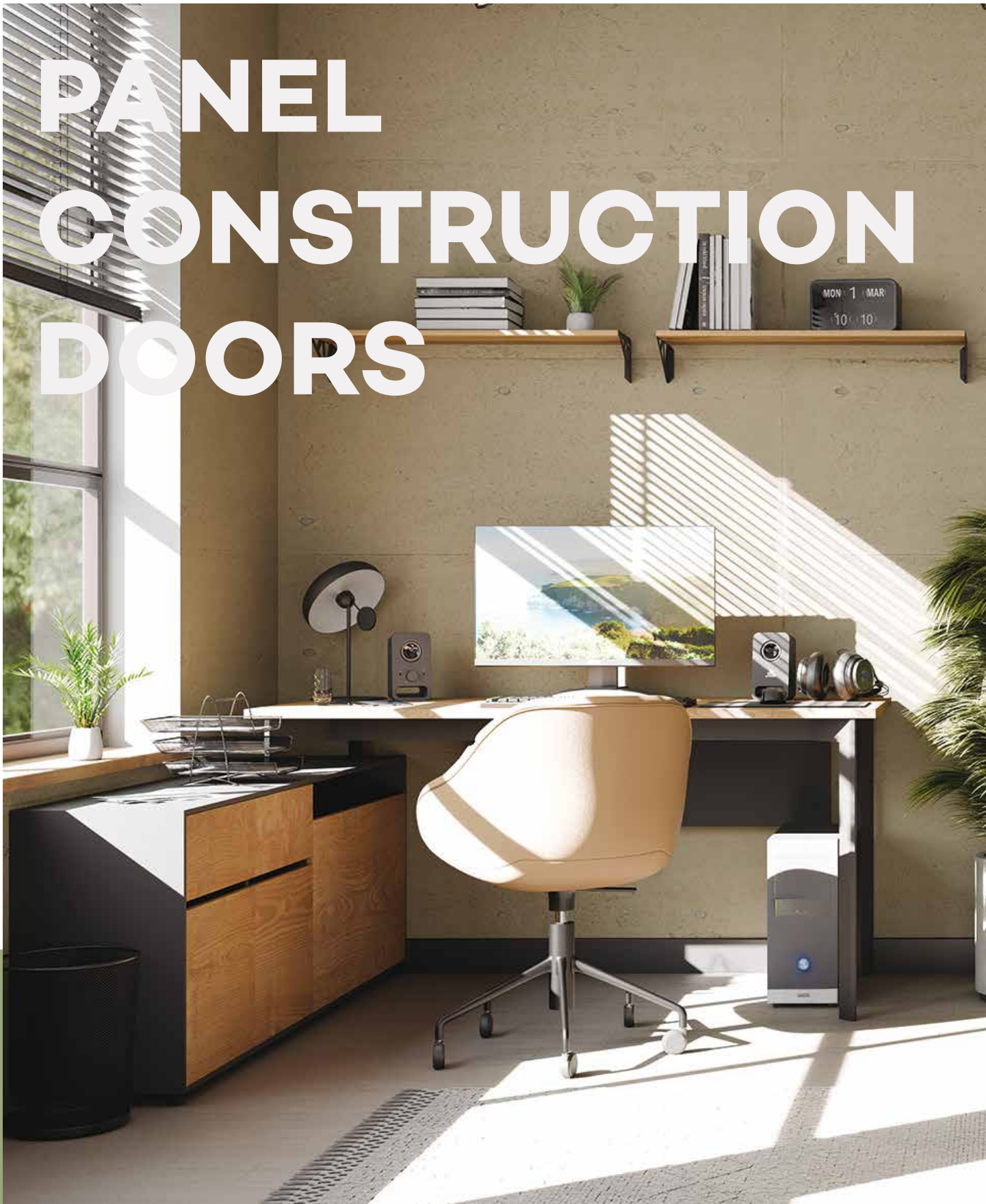

Panel construction doors are covered with foils, laminates or acrylic lacquers. They combine aesthetics, durability and wide personalization possibilities, while being an economical and functional solution.



RIVIA 10 - marrone chestnut/black ST

NOVA



NOVA 80 - sage oak (structure), brushed gold inlay



NOVA 70 - warm grey matt

DECORS

DRE CELL1	white matt	light gray matt	warm gray matt	cashmere matt	sage oak (textured)	NEW sage matt	dark olive matt
		dark blue matt	antique copper	oxide concrete			
CPL	black ST						
Inlays	steel brushed	brushed gold	moro matt				



NOTE: the Silent package applies to rebated and non-rebated single leaf door.

STANDARD OPTIONS

- door leaf frame made of softwood
- core made of „honeycomb“
- glass pane MAT DRE 4 mm thick
- the edge in the color of the door leaf or black
- concrete oxide and antique copper decors available only with black edge

OPTIONS WITHOUT EXTRA CHARGE

- ventilation sleeves
- three hinges - applies to rebated door leaf
- glass pane DECORMAT BROWN, DECORMAT GRAPHITE and transparent glass pane

REBATED DOOR LEAF

- straight edge
- 2 silver screw-in pivot hinges
- silver or black deadbolt lock with a simple key, bathroom lock, cylinder lock or economic lock

NON-REBATED OPENING DOOR LEAF

(extra charge)

- edge whitout rebate
- sockets for 2 hidden concealed Estetic 80 hinges (non-rebated door frames are equipped with hinges)
- magnetic/mechanical lock for a simple key, bathroom lock, cylinder lock or economic lock in steel and black color or magnetic in white, gold color - to choose from

SLIDING DOOR LEAF

- edge whitout rebate
- socket for hook lock and/or for handles

DOOR LEAF WITH INVERETED REBATE (extra charge)

- active single leaf door
- straight edge
- sockets for two recessed Estetic 1821 hinges (hinges constitute a part of the door frame)
- magnetic simple key lock, bathroom lock, cylinder lock or economic lock
- does not apply to door leaves with antique copper or oxide concrete decors

DOOR FRAMES

- for door leaves from NOVA collection it is recommended to use door frames in the same colour as door leaf or in black matt 2 decor

OPTIONS AVAILABLE WITH EXTRA CHARGE

- Silent 37dB package (dropping seal + acoustic filling) - NOVA 10, 50 - 80
- stabilising insert tubular chipboard
- non-rebated door leaf
- door leaf "90", "100"
- ventilation undercut
- recuperative shortcut -8mm
- door leaf with inverted rebate
- plastic ventilation grille
- aluminum ventilation grille
- black fittings for rebated door leaf
- It is possible to buy only the steel BULAJ in black or stainless steel at a price

NOTE: Third Estetic 80 hinge for non-rebated doors (extra charge is added to the price of the door frame)

NOTE: THE SILENT PACKAGE APPLIES TO REBATED AND NON-REBATED SINGLE LEAF DOOR.

NOVA MODELS



NOVA 10



NOVA 20



NOVA 30



NOVA 40



NOVA 50



NOVA 60



NOVA 70



NOVA 80



NOVA



NOVA 10 - natural halifax oak



NOVA 80 - natural halifax oak

DECORS

LAMINATES EGGER 1st group	gray oak halifax	natural oak halifax	Halifax Tabac Oak	
	LAMINATES CLEAF 2nd group	white elm	elm natural	elm dark
	Inlays	steel brushed	brushed gold	more matt

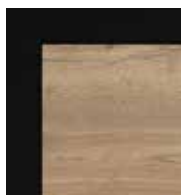

The option of combining the door frame in the DRE-Cell black matt 2 foil and natural halifax oak laminate



NOTE: the Silent package applies to rebated and non-rebated single leaf door.

NOVA

NOVA

REBATED AND NON-REBATED DOOR LEAVES

interior doors

STANDARD OPTIONS

- door leaf surface is coated with laminated, synchronous 3 mm or 4 mm thick board
- door leaf frame made of softwood
- core made of „honeycomb“
- glass pane MAT DRE 4 mm thick
- edgeband in black colour
- for natural halifax oak decor, the edge in the color of the door leaf or black
- NOVA 50 - 80 Vertical inlays made of laminate: brushed steel, brushed gold or moro matt

OPTIONS WITHOUT EXTRA CHARGE

- ventilation sleeves
- three hinges - applies to rebated door leaf
- glass pane DECORMAT BROWN, DECORMAT GRAPHITE and transparent glass pane

REBATED DOOR LEAF

- straight edge
- 2 silver screw-in pivot hinges
- silver or black deadbolt lock with a simple key, bathroom lock, cylinder lock or economic lock

NON-REBATED OPENING DOOR LEAF

(extra charge)

- edge whitout rebate
- sockets for 2 hidden concealed Estetic 80 hinges (non-rebated door frames are equipped with hinges)
- magnetic/mechanical lock for simple key, bathroom lock, cylinder lock or economic lock in steel and black color or magnetic in white color - to choose from

SLIDING DOOR LEAF

- edge whitout rebate
- socket for hook lock and/or for handles

DOOR FRAMES

- for door leaves from NOVA collection we recommend door frames in DRE-CELL black matt 2 foil and in CPL laminate natural halifax oak for door leaves made in laminate natural halifax oak, in longitudinal arrangement in the second CPL price group

OPTIONS AVAILABLE WITH EXTRA CHARGE

- Silent 37dB package (dropping seal + acoustic filling)NOVA 10,50-80 1st gr. of Egger laminates
- stabilising insert tubular chipboard
- non-rebated door leaf
- "100" door leaves
- ventilation undercut
- recuperative shortcut -8mm
- plastic ventilation grille
- aluminum ventilation grille
- black fittings for rebated door leaf
- It is possible to buy only the steel BULAJ in black or stainless steel at a price

NOTE: Third Estetic 80 hinge for non-rebated doors (extra charge is added to the price of the door frame)

NOTE: THE SILENT PACKAGE APPLIES TO REBATED AND NON-REBATED SINGLE LEAF DOOR.

steel BULAJ NOVA 30 - in the steel or black colour. Available only MAT or transparent glass pane.

NOVA MODELS

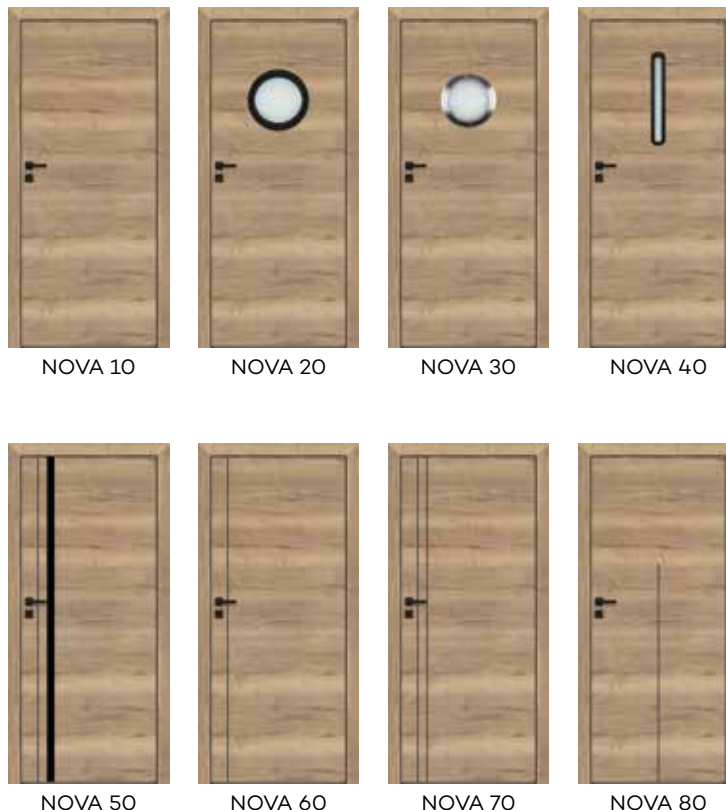

Width of door leaf: single-leaf "60"-"100"

Technical information: door frames: pp. 144-167, accessories: pp. 168-174 and 181, door leaves: pp. 182-195.

WOOD



WOOD M1 design W2 - dark oak



WOOD M1 pattern W1 - dark oak

DECORS

DECORS	light oak	oak classic	oak dark
--------	-----------	-------------	----------



WOOD

WOOD

NON-REBATED DOOR LEAVES

interior doors

STANDARD OPTIONS

- door leaf surface coated with the primer material, overprinted with the pattern and varnished
- matt lacquer
- door leaf frame made of MDF
- stabilising insert honeycomb
- glass pane MAT DRE 4 mm thick

NON-REBATED DOOR LEAF

- edge without rebate in the colour of the door leaf
- sockets for 2 recessed Estetic 80 hinges in steel, black or white color (hinges constitute a part of the door frame)
- magnetic/mechanical lock for simple key, bathroom lock, cylinder lock or economic lock in steel and black color or magnetic in white color - to choose from

DOOR FRAMES

- for the door leaves from the WOOD collection, we recommend to use lacquered frames made in the DRE-PRINT technology in the colour of door leaf unit

OPTION WITHOUT EXTRA CHARGE

- holes for ventilation sleeves
- glass pane DECORMAT BROWN, DECORMAT GRAPHITE and transparent glass pane

OPTIONS AVAILABLE WITH EXTRA CHARGE

- door leaf „100“
- stabilising insert tubular chipboard
- ventilation undercut
- aluminum ventilation grille

NOTE: Third Estetic 80 hinge for non-rebated doors (extra charge is added to the price of the door frame)

MODEL OPTIONS WITH POSSIBILITY TO CHOOSE GRAPHIC PATTERNS W1-W4 :

- M1 - full door leaf, without glazing
- M2 - MDF bulaj in black matt decor
- M3 - steel BULAJ in steel or black colour (only MATT or transparent glass pane available)
- M4 - MDF frame in black matt decor

WOOD MODELS

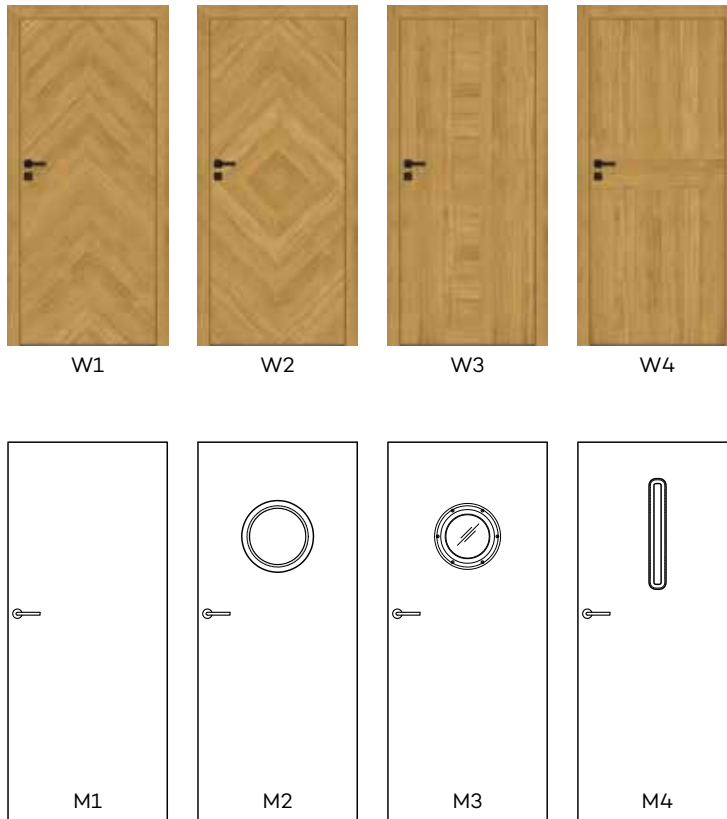

Width of door leaf: single-leaf "60"- "100"

Technical information: door frames: pp. 144-167, accessories: pp. 168-174 and 181, door leaves: pp. 182-195.

Grafi



GRAFI M4 - G2



GRAFI M1 - G17



DECORS

25 graphic designs

 to choose from.

More on page 178 of the catalogue and on www.dre.pl. Top quality digital printing secured with matt or gloss varnish, which guarantees print and colour durability.

fig. 1



White edge,
white lock



Black edge,
black toilet door lock

STANDARD HIGH GLOSS LACQUERED DOOR LEAF

- door leaf surface coated with the primer material, overprinted with the pattern and varnished (colour of the door leaf primed surface - white)
- high gloss lacquer
- door leaf frame made of MDF
- core made of tubular chipboard
- MAT DRE glass pane 4 mm thick (model M2, M4)

STANDARD MATT LACQUERED DOOR LEAF

- door leaf surface coated with the primer material, overprinted with the pattern and varnished (colour of the door leaf primed surface - white)
- matt lacquer
- door leaf frame made of MDF
- core made of „honeycomb“
- MAT DRE glass pane 4 mm thick (model M2, M4)

NON-REBATED DOOR LEAF

- edge without rebate in white or black colour fig.1
- sockets for 2 recessed Estetic 80 hinges in white, steel or black color (hinges constitute a part of the door frame)
- magnetic/mechanical lock for simple key, bathroom lock, cylinder lock or economic lock in steel and black color or magnetic in white color - to choose from

DOOR FRAMES

- for GRAFI collection , we recommend to use white, black lacquered door frames made in DRE-PRINT technology, or door frames in black matt 2

OPTION WITHOUT EXTRA CHARGE

- holes for ventilation sleeves
- DECORMAT BROWN, DECORMAT GRAPHITE and transparent glass (model M2, M4)

OPTIONS AVAILABLE WITH EXTRA CHARGE

- door leaf „100“
 - ventilation undercut
 - tubular chipboard filling in matt varnished doors
 - aluminum ventilation grille
- NOTE: Third Estetic 80 hinge for non-rebated doors (extra charge is added to the price of the door frame)

MODEL OPTIONS TO BE CHOSEN WITH THE POSSIBILITY OF USAGE OF GRAPHIC PATTERNS G1-G25:

- M1 - full door leaf, without glazing
- M2 - MDF bulaj in black matt decor
- M3 - steel BULAJ in steel or black colour (only MATT or transparent glass pane available)
- M4 - MDF frame in black matt decor

GRAFI MODELS

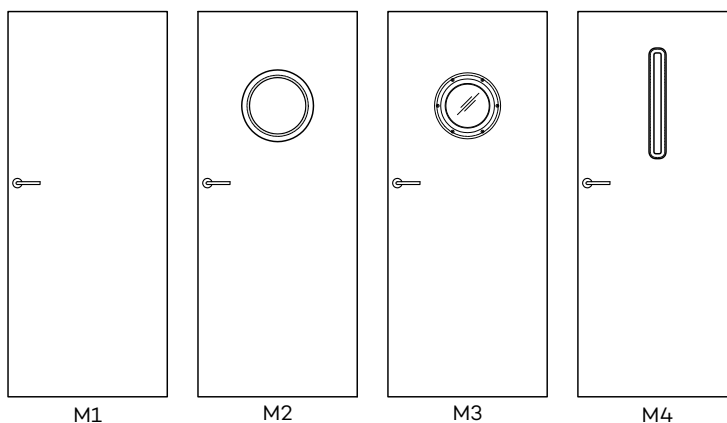

Designs of 25 graphics available on page 178 of the catalogue and on the website www.dre.pl

Lux LUX



LUX 10 - birch



LUX 20 - viking oak

DECORS



Black edge,
black toilet door lock



STANDARD OPTIONS

- door leaf surface is coated with primer material in the colour of decor and varnished
- high gloss lacquer
- door leaf frame made of MDF
- core made of perforated chipboard
- MAT DRE glass pane 4 mm thick (model LUX 20, LUX 40)

NON-REBATED DOOR LEAF

- edge without rebate in black colour fig.1
- sockets for 2 recessed Estetic 80 hinges in black, white or steel color (hinges constitute a part of the door frame)
- magnetic/mechanical lock for simple key, bathroom lock, cylinder lock or economic lock in steel and black color or magnetic in white color - to choose from

DOOR FRAMES

- for door leaves from LUX collection we recommend to use door frames lacquered in the same colour as the door leaf unit or in black matt decor 2

OPTION WITHOUT EXTRA CHARGE

- holes for ventilation sleeves
- DECORMAT BROWN, DECORMAT GRAPHITE and transparent glass (model LUX 20, LUX 40)

OPTIONS AVAILABLE WITH EXTRA CHARGE

- door leaf „100“
- ventilation undercut
- aluminum ventilation grille

NOTE: Third Estetic 80 hinge for non-rebated doors (extra charge is added to the price of the door frame)

steel BULAJ LUX 30- in the steel or black colour. Available only MAT or transparent glass pane.

LUX MODELS



LUX 10



LUX 20



LUX 30



LUX 40

RIVIA



RIVIA 10 - marrone chestnut / black ST



RIVIA 70 - marrone chestnut /white matt

DECORS

DRE CELL	White matt	White pine	siberian elm	sand oak	bleached oak textured	vintage oak	walnut
	NEW						
	natur oak premium	anthracite elm	dark wenge	marrone chestnut textured	evoke oak	walnut caramel	toffee oak* ***
	light gray matt	silver					
3D	grand oak	elm	american walnut	ebony*	Polish oak 3D		

***decor only in horizontal grain, *decor available while stocks last



Rivia 20 white matt base Rivia 20 black ST base



RIVIA

RIVIA

REBATED, NON-REBATED DOOR LEAVES

interior doors

STANDARD OPTIONS

- door leaf frame made of softwood
- core made of tubular chipboard
- glass pane white bark 4 mm thick

OPTIONS WITHOUT EXTRA CHARGE

- glass pane „chinchila” or „window blind”
- ventilation sleeves
- three hinges - applies to rebated door leaf

REBATED DOOR LEAF

- straight edge, uniform flat glazing frame
- 2 silver screw-in pivot hinges
- single-point mortise simple key lock, bathroom lock, cylinder lock or economic lock

NON-REBATED OPENING DOOR LEAF

(extra charge)

- edge without rebate, uniform flat glazing frame
- sockets for 2 recessed Estetic 80 hinges (hinges constitute a part of the door frame)
- magnetic/mechanical lock with a simple key, bathroom lock, cylinder lock or economic lock

SLIDING DOOR LEAF

- edge without rebate, uniform flat glazing frame
- socket for hook lock and/or for handles

*** In RIVIA 70 and 120 models, the insert in the selected color has vertical graining, except for the toffee oak color. In other models, inserts have horizontal graining.

OPTIONS AVAILABLE WITH EXTRA CHARGE

- glass pane MAT DRE, DECORMAT BROWN, DECORMAT GRAPHITE, (applies to door leaf) RIVIA 20, 30 RIVIA 40, 50
- white frost VSG 22.1 safe, complex glass pane RIVIA 20, 30 RIVIA 40, 50
- non-rebated door leaf
- door leaf width "90" and "100"
- ventilation undercut
- recuperative shortcut -8mm
- plastic ventilation grille
- aluminum ventilation grille
- black fittings for rebated door leaf

NOTE: Third Estetic 80 hinge for non-rebated doors (extra charge is added to the price of the door frame)

NOTE: The door leaf is made in white matt or black ST with a choice of center stripe decor. The edge of the door leaf is in the color of the central stripe. RIVIA 40 - BULAJ is covered with white or black PVC foil, RIVIA 50 - BULAJ is covered with silver foil.

By default, the configurator selects the colour of the door frame in the same colour as the middle strip of the door leaf unit.

RIVIA MODELS



Width of door leaf: single-leaf "60"- "100"

Technical information: door frames: pp. 144-167, accessories: pp. 168-174 and 181, door leaves: pp. 182-195.

Galeria Alu



GALERIA ALU 20 - anthracite elm



GALERIA ALU 50 - acacia

DECORS

DRE CELL	white (textured)	White matt	White pine	siberian elm	sand oak	bleached oak textured	vintage oak
	walnut	NEW natur oak premium	anthracite elm	dark wenge	marrone chestnut textured	evoke oak	walnut caramel
	toffee oak**, ***	light gray matt	silver				
3D	grand oak	elm	american walnut	ebony**	Polish oak 3D		
CPL laminate*	white	milky white	ashen	dark gray	concrete 2	gray oak	welsh oak
	acacia	celini walnut	walnut	honey oak	NEW natural hickory	roasted walnut	black ST

* laminate available in models 10, 20, 30, 50, 60, ** decor available while stocks last

*** decor available only in horizontal wood grain



8mm inserts located in one plane with the door leaf surface on both sides

GALERIA

Galeria Alu

REBATED, NON-REBATED DOOR LEAVES
interior doors

STANDARD OPTIONS

- door leaf frame made of softwood
- core made of tubular chipboard
- edge with radius R 2,5 mm used in 0,15-0,20 mm CPL laminates
- decorative inserts 8 mm
- glass pane white bark 4 mm thick

OPTIONS WITHOUT EXTRA CHARGE

- glass pane „chinchila” or „window blind”
- ventilation sleeves
- three hinges - applies to rebated door leaf

REBATED DOOR LEAF

- straight edge, flat glazing bar
- 2 silver screw-in pivot hinges
- a deadbolt lock with a simple key, a bathroom lock, a cylinder insert or an economic lock
- straight edge or edge with a radius R 2.5 mm made by direct-forming (in CPL laminate)

NON-REBATED OPENING DOOR LEAF

(extra charge)

- edge without rebate, flat glazing bar
- sockets for 2 recessed Estetic 80 hinges (hinges constitute a part of the door frame)
- magnetic/mechanical lock with a simple key, bathroom lock, cylinder lock or economic lock

SLIDING DOOR LEAF

- edge without rebate, flat glazing bar
- socket for hook lock and/or for handles

NOTE: passive door leaf GALERIA ALU 20, 21, 22, 23, 24, 25, 60 without horizontal inserts in a uniform grain.

OPTIONS AVAILABLE WITH EXTRA CHARGE

- Silent package 37dB (dropping seal + acoustic insert) - GALERIA ALU 10 - 60
- glass pane MAT DRE, DECORMAT BROWN, DECORMAT GRAPHITE, (applies to door leaf)
GALERIA ALU 11, 13, 23
GALERIA ALU 21
GALERIA ALU 24, 25
GALERIA ALU 12, 22
- white frost VSG 22.1 safe, complex glass pane
GALERIA ALU 11
GALERIA ALU 13, 23
GALERIA ALU 21
GALERIA ALU 24
GALERIA ALU 25
GALERIA ALU 12
GALERIA ALU 22
- non-rebated door leaf
- door leaf "90" and "100"
- ventilation undercut
- recuperative shortcut -8mm
- plastic ventilation grille
- aluminum ventilation grille
- cover strip for double non-rebated door leaf
- black fittings for rebated door leaf
- double leaf door leaf price x2

NOTE: Third Estetic 80 hinge for non-rebated doors (extra charge is added to the price of the door frame)

NOTE: THE SILENT PACKAGE APPLIES TO REBATED AND NON-REBATED SINGLE LEAF DOOR.

GALERIA ALU MODELS



galeria alu 10



GALERIA ALU
20



galeria alu 30



galeria alu 50



galeria alu 60



galeria alu 11



galeria alu 12



galeria alu 13



galeria alu 21



galeria alu 22



galeria alu 23



galeria alu 24



galeria alu 25



Door leaf width: single leaf "60" ÷ "100", double leaf rebated "120" ÷ "200", double leaf non-rebated "120" ÷ "180".
Technical information: door frames: pp. 144-167, accessories: pp. 168-174 and 181, door leaves: pp. 182-195.

FINEA FINEA B



FINEA 40 - vintage oak



FINEA 60 - sand oak

DECORS

DRE CELL	white (textured)	White matt	White pine	siberian elm	sand oak	bleached oak textured	vintage oak
	walnut	NEW natur oak premium	anthracite elm	dark wenge	marrone chestnut textured	evoke oak	walnut caramel
	toffee oak* ***	light gray matt	silver				
3D	grand oak	elm	american walnut	ebony*	Polish oak 3D		

*decor available while stocks last, ***decor only in horizontal grain



FINEA and FINEA B

REBATED, NON-REBATED DOOR LEAVES

interior doors

STANDARD OPTIONS

- door leaf frame made of softwood
- core made of tubular chipboard
- glass pane white bark 4 mm thick

OPTIONS WITHOUT EXTRA CHARGE

- glass pane „chinchila” or „window blind”
- ventilation sleeves
- three hinges - applies to rebated door leaf

REBATED DOOR LEAF

- straight edge, flat glazing bar
- 2 silver screw-in pivot hinges
- single-point mortise simple key lock, bathroom lock, cylinder lock or economic lock

NON-REBATED OPENING DOOR LEAF

(extra charge)

- edge without rebate, flat glazing bar
- sockets for 2 recessed Estetic 80 hinges (hinges constitute a part of the door frame)
- magnetic/mechanical lock with a simple key, bathroom lock, cylinder lock or economic lock

SLIDING DOOR LEAF

- edge without rebate, flat glazing bar
- socket for hook lock and/or for handles

OPTIONS AVAILABLE WITH EXTRA CHARGE

- glass pane MAT DRE, DECORMAT BROWN, DECORMAT GRAPHITE (applies to door leaf)

FINEA 20, FINEA B 20

FINEA 30, 50, 60, FINEA B 30, 50, 60

- white frost VSG 22.1 safe, complex glass pane

FINEA 20, FINEA B 20

FINEA 30, FINEA B 30

FINEA 50, 60, FINEA B 50, 60

- non-rebated door leaf
- door leaf width "90" and "100"
- ventilation undercut

- recuperative shortcut -8mm

- plastic ventilation grille

- aluminum ventilation grille

- black fittings for rebated door leaf

NOTE: Third Estetic 80 hinge for non-rebated doors (extra charge is added to the price of the door frame)

FINEA and FINEA B MODELS



finea 10
FINEA B 10*



finea 20
FINEA B 20*



finea 30
FINEA B 30*



finea 40
FINEA B 40*



finea 50
FINEA B 50*



finea 60
FINEA B 60*



panels wood grain in
FINEA



*horizontal graining of
FINEA B panels

DECO



DECO 20 - concrete 2, black SLIM frame



DECO 30 - elm

DECORS

DRE CELL	white (textured)	White matt	White pine	siberian elm	sand oak	bleached oak textured	vintage oak
	walnut	NEW natur oak premium	anthracite elm	dark wenge	marrone chestnut textured	evoked oak	walnut caramel
	toffee oak* ***	light gray matt	silver				
3D	grand oak	elm	american walnut	ebony*	Polish oak 3D		
CPL Laminate	white	milky white	ashen	dark gray	concrete 2	gray oak	welsh oak
	acacia	celini walnut	walnut	honey oak	NEW natural hickory	roasted walnut	black ST

*decor available while stocks last, ***decor only in horizontal grain



STANDARD OPTIONS

- door leaf frame made of softwood
- edge radius R 2.5 mm for CPL laminates 0.15-0.2 mm except for white, milky white, gray
- core made of „honeycomb”
- glass pane white bark 4 mm thick
- flat 4mm HDF panel in DECO 40

OPTIONS WITHOUT EXTRA CHARGE

- glass pane „chinchila” or „window blind”
- ventilation sleeves
- three hinges - applies to rebated door leaf

REBATED DOOR LEAF

- straight edge, flat glazing frame in the door leaf decor or black Slim
- 2 silver screw-in pivot hinges
- single-point mortise simple key lock, bathroom lock, cylinder lock or economic lock
- rounded frame, straight edge or edge with a radius R 2.5 mm made using the directforming method (in CPL laminate)

NON-REBATED OPENING DOOR LEAF

(extra charge)

- edge without rebate, flat glazing frame in the door leaf decor or black Slim
- sockets for 2 hidden recessed Estetic 80 hinges (hinges constitute a part of the door frame)
- magnetic/mechanical lock with a simple key, bathroom lock, cylinder lock or economic lock
- edge without rebate, rounded glazing frame (in CPL laminate)

SLIDING SYSTEM DOOR LEAF

- edge without rebate and optionally: flat glazing frame in the door leaf decor or black Slim or rounded glazing frame
- socket for hook lock and/or for handles
- edge without rebate, rounded glazing frame (in CPL laminate)

OPTIONS AVAILABLE WITH EXTRA CHARGE

- decorative glass MAT DRE, DECORMAT BROWN, DECORMAT GRAPHITE (for door leaf) DECO 10, 20, 30
- white frost VSG 22.1 safe, complex glass pane DECO 10, 20, 30
- stabilising insert tubular chipboard
- non-rebated door leaf
- door leaf "90" and "100"
- ventilation undercut
- recuperative shortcut -8mm
- plastic ventilation grille
- aluminum ventilation grille
- cover strip for double non-rebated door leaf
- black fittings for rebated door leaf
- double leaf door

leaf price x2

NOTE: Third Estetic 80 hinge for non-rebated doors (extra charge is added to the price of the door frame)

DECO MODELS



deco 10



deco 20



deco 30



deco 40



deco 10
with black glazing
bar SLIM



deco 20
with black glass
pane frame SLIM



deco 30
with black glass
pane frame SLIM



deco 40
with black glass
pane frame SLIM

Modern



MODERN 20 - white matt



MODERN 30 - marrone chestnut textured

DECORS

DRE CELL	white (textured)	White matt	White pine	siberian elm	sand oak	bleached oak textured	vintage oak
	walnut	NEW natur oak premium	anthracite elm	dark wenge	marrone chestnut textured	evoked oak	walnut caramel
	toffee oak* ***	light gray matt	silver				
3D	grand oak	elm	american walnut	ebony*	Polish oak 3D		
CPL Laminate	white	milky white	ashen	welsh oak	acacia	celini walnut	walnut
	honey oak	NEW natural hickory	roasted walnut	black ST	dark gray	concrete 2	gray oak

*decor available while stocks last, ***decor only in horizontal grain



Modern

Modern

DOOR LEAVES - REBATED, NON-REBATED, WITH VARIABLE HEIGHTS

interior doors

STANDARD OPTIONS

- door leaf frame made of softwood
- core made of „honeycomb“
- glass pane white bark 4 mm thick

OPTIONS WITHOUT EXTRA CHARGE

- glass pane „chinchila“ or „window blind“
- ventilation sleeves
- three hinges - applies to rebated door leaf

REBATED DOOR LEAF

- straight edge, flat glass pane frame (in CPL laminate - rounded) in door leaf decor or black Slim, 4 mm flat HDF panels
- 2 pcs. of silver screw-in hinges, 3 pcs. with variable heights
- single-point mortise simple key lock, bathroom lock, cylinder lock or economic lock

NON-REBATED DOOR LEAF (EXTRA CHARGE)

- edge without rebate, flat glass pane frame (in CPL laminate - rounded), in door leaf decor or black Slim, 4 mm flat HDF panels
- sockets for 2 hidden concealed Estetic 80 hinges (non-rebated door frames are equipped with hinges)
- magnetic/mechanical lock with a simple key, bathroom lock, cylinder lock or economic lock

SLIDING DOOR LEAF (does not apply to height 1983)

- edge without rebate and optionally: flat glazing frame in the door leaf decor or black Slim, flat HDF panels 4 mm thick or rounded glazing frame, profiled MDF panels 19 mm thick
- socket for hook lock and/or for handles
- in CPL laminate, edge without rebate and optionally: rounded glass pane frame in the colour of the door leaf or black Slim

4 mm flat HDF panels

OPTIONS AVAILABLE WITH EXTRA CHARGE

- glass pane MAT DRE, DECORMAT BROWN, DECORMAT GRAPHITE, (applies to door leaf)
- MODERN 20
- MODERN 30
- MODERN 40
- MODERN 50
- white frost VSG 22.1 safe, complex glass pane
- MODERN 20
- MODERN 30
- MODERN 40
- MODERN 50
- stabilising insert:
- core made of: tubular chipboard (1983 and 2043)
- tubular chipboard (2110 and 2240)
- door leaf „90“ and „100“ (1983 and 2043)
- door leaf "90" and "100" (2110 and 2240)
- non-rebated door leaf
- ventilation undercut
- recuperative shortcut -8mm
- plastic ventilation grille
- aluminum ventilation grille
- cover strip for double non-rebated door leaf
- black fittings for rebated door leaf
- double leaf door

leaf price x2

NOTE: Third Estetic 80 hinge for non-rebated doors (extra charge is added to the price of the door frame)

NOTE: In rebated door leaves with CPL laminates there is possibility to choose a door leaf with an edge radius R=2.5 mm, except for white, milky white and gray laminates.

MODERN MODELS



modern 10



modern 20



modern 30



modern 40



modern 50



modern 10
with black glazing
bar SLIM



modern 20
with black glazing
bar SLIM



modern 30
with black glazing
bar SLIM



modern 40
with black glazing
bar SLIM



modern 50
with black glass
pane frame SLIM

Door leaf width: single leaf "60" ÷ "100", double leaf rebated "120" ÷ "200", double leaf non-rebated "120" ÷ "180".
Technical information: door frames: pp. 144-167, accessories: pp. 168-174 and 181, door leaves: pp. 182-195.

Plus



PLUS 30 height 2240 - white matt



PLUS 30 - grey oak

DECORS

DRE CELL	white (textured)	White matt	White pine	siberian elm	sand oak	bleached oak textured	vintage oak
	walnut	NEW natur oak premium	anthracite elm	dark wenge	marrone chestnut textured	evoke oak	walnut caramel
	toffee oak* ***	light gray matt	silver				
3D	grand oak	elm	american walnut	ebony*	Polish oak 3D		
CPL Laminate	white	milky white	ashen	welsh oak	acacia	celini walnut	walnut
	honey oak	NEW natural hickory	roasted walnut	black ST	dark gray	concrete 2	gray oak

*decor available while stocks last, ***decor only in horizontal grain



STANDARD OPTIONS

- door leaf frame made of softwood
- core made of „honeycomb“
- glass pane white bark 4 mm thick

OPTIONS WITHOUT EXTRA CHARGE

- glass pane „chinchila“ or „window blind“
- ventilation sleeves
- three hinges - applies to rebated door leaf

REBATED DOOR LEAF

- straight edge, flat glass pane (in CPL laminate - rounded), 4 mm thick HDF flat panels
- 2 pcs. of silver screw-in hinges, 3 pcs. with variable heights
- single-point mortise lock for simple key, for bathroom lock, for cylinder lock or economic lock

NON-REBATED DOOR LEAF (EXTRA CHARGE)

- edge without rebate, flat glass pane frame (in CPL laminate - rounded), 4 mm flat HDF panels
- sockets for 2 recessed Estetic 80 hinges (hinges constitute a part of the door frame)
- magnetic/mechanical lock with a simple key, bathroom lock, cylinder lock or economic lock

SLIDING DOOR LEAF (does not apply to height 1983)

- edge without rebate, 4 mm flat HDF panels and optionally: flat glass pane frame or rounded glass pane frame (only rounded in CPL laminate)
- socket for hook lock and/or for handles

OPTIONS AVAILABLE WITH EXTRA CHARGE

- glass pane MAT DRE, DECORMAT BROWN, DECORMAT GRAPHITE (applies to door leaf)
- PLUS 20

- PLUS 40, 50, 60, 70, 80
- PLUS 30
- opal glass VSG 22.1, safety composite
- PLUS 20, 50, 60
- PLUS 30
- PLUS 40
- PLUS 70, 80
- filling: tubular chipboard (1983 and 2043) tubular chipboard (2110 and 2240)
- door leaf „90“ and „100“ (1983 and 2043)
- door leaf "90" and "100" (2110 and 2240)
- non-rebated door leaf
- ventilation undercut
- recuperative shortcut -8mm
- plastic ventilation grille
- aluminum ventilation grille
- cover strip for double non-rebated door leaf
- black fittings for rebated door leaf
- double leaf door

leaf price x2

NOTE: Third Estetic 80 hinge for non-rebated doors (extra charge is added to the price of the door frame)

NOTE: colours equivalent: W0118 - WHITE

NOTE: In rebated door leaves with CPL laminates there is possibility to choose a door leaf with an edge radius R=2.5 mm, except for white, milky white and gray laminates.

NOTE: Different heights are available in all models of PLUS collection.

Door leaf, dependent on selected height option - 1983 mm, 2110 mm or 2240 mm is dedicated to door frames with three hinges in corresponding heights.

PLUS MODELS



PLUS 10



PLUS 20



PLUS 30



PLUS 40



PLUS 50



PLUS 60



PLUS 70



PLUS 80

STANDARD



STANDARD 10 - evoke oak door frame black matt 2

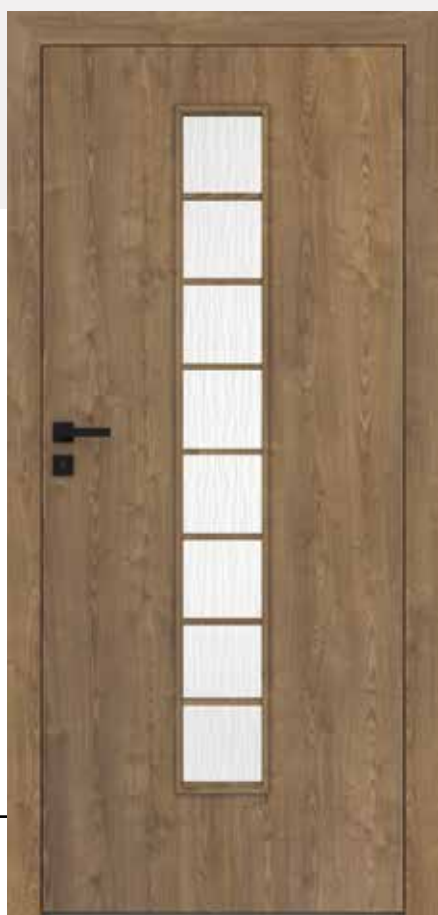

STANDARD 40S - chestnut marrone structure

DECORS

DRE CELL	white (textured)	White matt	White pine	siberian elm	sand oak	bleached oak textured	vintage oak
	walnut	NEW natur oak premium	anthracite elm	dark wenge	marrone chestnut textured	evoke oak	walnut caramel
	toffee oak**, ***	light gray matt	silver				
3D	grand oak	elm	american walnut	ebony**	Polish oak 3D		

*decor available while stocks last, **decor only in horizontal grain



STANDARD STANDARD

REBATED, NON-REBATED DOOR LEAVES

interior doors

STANDARD OPTIONS

- door leaf frame made of softwood
- core made of „honeycomb“
- glass pane white bark 4 mm thick

OPTIONS WITHOUT EXTRA CHARGE

- glass pane „chinchila“ or „window blind“
- ventilation sleeves
- three hinges - applies to rebated door leaf

REBATED DOOR LEAF

- straight edge, flat glazing bar
- 2 silver screw-in pivot hinges
- single-point mortise simple key lock, bathroom lock, cylinder lock or economic lock

All orders in the investment standard require approval of The Investment Department. The investment standard is defined by door frame passage, with opened door leaf at 90 degree, respectively for interior doors: "80" 800 mm, "90" 900 mm.

NON-REBATED OPENING DOOR LEAF

(extra charge)

- edge without rebate, flat glazing bar
- sockets for 2 recessed Estetic 80 hinges (hinges constitute a part of the door frame)
- magnetic/mechanical lock with a simple key, bathroom lock, cylinder lock or economic lock

SLIDING DOOR LEAF

- edge without rebate and optional: flat or rounded glazing frame
- socket for hook lock and/or for handles

NOTE: the Silent package applies to rebated and non-rebated single leaf door.

NOTE: Selected configurations of STANDARD 10 rebated model in the evoke oak color are available from stock.

OPTIONS AVAILABLE WITH EXTRA CHARGE

- Silent package 37dB (dropping seal + acoustic insert) - STANDARD 10
 - glass pane MAT DRE, DECORMAT BROWN, DECORMAT GRAPHITE (applies to door leaf) STANDARD 20, 20s, 40, 40s, BULAJ MDF STANDARD 50, 50s STANDARD 30, 30s STANDARD 60
 - white frost VSG 22.1 safe, complex glass pane STANDARD 20, 20s, 40, 40s STANDARD 50, 50s, MDF BULAJ STANDARD 30, 30s STANDARD 60
 - stabilising insert tubular chipboard
 - non-rebated door leaf
 - door leaf "90" and "100"
 - rebated door leaf "110" (only STANDARD 10)
 - upper single point mortise lock (only STANDARD 10 with tubular chipboard and fixed door frame)
 - ventilation undercut
 - recuperative shortcut -8mm
 - plastic ventilation grille
 - aluminum ventilation grille
 - non-rebated double door closing strip closing strip
 - black fittings for rebated door leaf
 - double leaf door door leaf price x 2
 - it is possible to buy only steel BULAJ in black or steel color - included in the price
- NOTE: Third Estetic 80 hinge for non-rebated doors (extra charge is added to the price of the door frame)

STANDARD MODELS



Door leaf width: single leaf "60" ÷ "100", double leaf rebated "120" ÷ "200", double leaf non-rebated "120" ÷ "180".
 Technical information: door frames: pp. 144-167, accessories: pp. 168-174 and 181, door leaves: pp. 182-195.

FANO



FANO 10 - elm



FANO 30S - grand oak

DECORS

DRE CELL	white (textured)	White matt	White pine	siberian elm	sand oak	bleached oak textured	vintage oak
	walnut	NEW natur oak premium	anthracite elm	dark wenge	marrone chestnut textured	evoked oak	walnut caramel
	toffee oak* ***	light gray matt	silver				
3D	grand oak	elm	american walnut	ebony*	Polish oak 3D		

*decor available while stocks last, ***decor only in horizontal grain



FANO

FANO

REBATED, NON-REBATED DOOR LEAVES

interior doors

STANDARD OPTIONS

- door leaf frame made of softwood
- core made of „honeycomb“
- glass pane white bark 4 mm thick

OPTIONS WITHOUT EXTRA CHARGE

- glass pane „chinchila“ or „window blind“
- ventilation sleeves
- three hinges - applies to rebated door leaf

REBATED DOOR LEAF

- straight edge, flat glazing bar
- 2 silver screw-in pivot hinges
- single-point mortise simple key lock, bathroom lock, cylinder lock or economic lock

NON-REBATED OPENING DOOR LEAF

(extra charge)

- edge without rebate, flat glazing frame, 19 mm thick MDF profiled panels
- sockets for 2 recessed Estetic 80 hinges (hinges constitute a part of the door frame)
- magnetic/mechanical lock with a simple key, bathroom lock, cylinder lock or economic lock

SLIDING DOOR LEAF

- edge without rebate, rounded or flat glazing frame, 19 mm thick profiled MDF panel
- socket for hook lock and/or for handles

OPTIONS AVAILABLE WITH EXTRA CHARGE

- glass pane MAT DRE, DECORMAT BROWN, DECORMAT GRAPHITE (applies to door leaf)
FANO 20, 20s
FANO 30, 30s
 - white frost VSG 22.1 safe, complex glass pane
FANO 20, 20s
FANO 30, 30s
 - stabilising insert tubular chipboard
 - non-rebated door leaf
 - door leaf "90" and "100"
 - ventilation undercut
 - recuperative shortcut -8mm
 - plastic ventilation grille
 - aluminum ventilation grille
 - cover strip for double non-rebated door leaf
 - black fittings for rebated door leaf
 - double leaf door leaf price x2
- NOTE: Third Estetic 80 hinge for non-rebated doors (extra charge is added to the price of the door frame)

FANO MODELS



FANO 10



FANO 20



FANO 20s



FANO 30



FANO 30s

Arte



ARTE 40 - sand oak



ARTE 20 - anthracite elm

DECORS

DRE CELL	white (textured)	White matt	White pine	siberian elm	sand oak	bleached oak textured	vintage oak
	walnut	NEW natur oak premium	anthracite elm	dark wenge	marrone chestnut textured	evoke oak	walnut caramel
	toffee oak* ***	light gray matt	silver				
3D	grand oak	elm	american walnut	ebony*	Polish oak 3D		

*decor available while stocks last, ***decor only in horizontal grain



STANDARD OPTIONS

- door leaf frame made of softwood
- core made of „honeycomb“
- glass pane white bark 4 mm thick

OPTIONS WITHOUT EXTRA CHARGE

- glass pane „chinchila“ or „window blind“
- ventilation sleeves
- three hinges – applies to rebated door leaf

REBATED DOOR LEAF

- straight edge, flat glazing bar
- 2 silver screw-in pivot hinges
- single-point mortise simple key lock, bathroom lock, cylinder lock or economic lock

NON-REBATED OPENING DOOR LEAF (extra charge)

- edge without rebate, flat glazing bar
- sockets for 2 recessed Estetic 80 hinges (hinges constitute a part of the door frame)
- magnetic/mechanical lock with a simple key, bathroom lock, cylinder lock or economic lock

SLIDING DOOR LEAF

- edge without rebate, rounded glazing frame or flat glazing frame
- socket for hook lock and/or for handles

OPTIONS AVAILABLE WITH EXTRA CHARGE

- glass pane MAT DRE, DECORMAT BROWN, DECORMAT GRAPHITE (applies to door leaf)
 - ARTE 10-30, 90
 - ARTE 40, 50
 - ARTE 80
 - white frost VSG 22.1 safe, complex glass pane
 - ARTE 10, 20, 30
 - ARTE 40, 50
 - ARTE 80
 - ARTE 90
 - stabilising insert tubular chipboard
 - non-rebated door leaf
 - door leaf "90" and "100"
 - ventilation undercut
 - recuperative shortcut –8mm
 - plastic ventilation grille
 - aluminum ventilation grille
 - cover strip for double non-rebated door leaf
 - black fittings for rebated door leaf
 - double leaf door leaf price x2
- NOTE: Third Estetic 80 hinge for non-rebated doors (extra charge is added to the price of the door frame)

ARTE MODELS



ARTE 10



ARTE 20



ARTE 30



ARTE 40



ARTE 50



ARTE 80



ARTE 90

UNI



UNI 10 - ashen

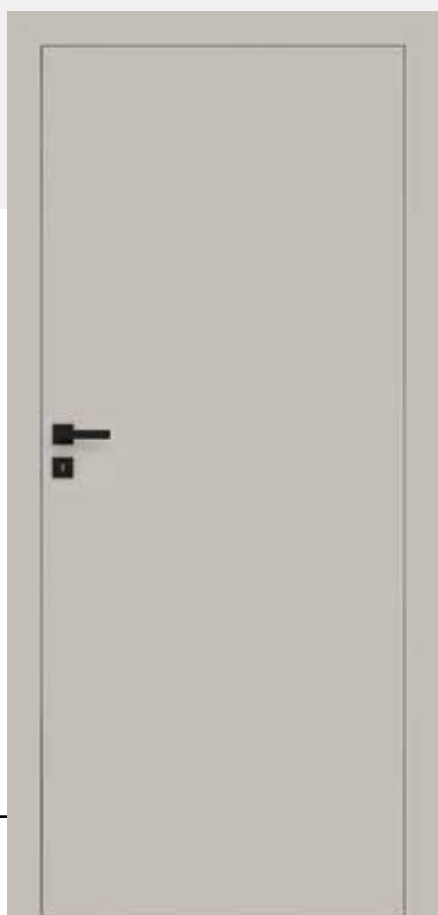

UNI 10 - cashmere

DECORS

		NEW	NEW		
PAINTED	white	cashmere	sabio	latte	ashen

white - UV acrylic varnish - RAL 9003
cashmere - NCS S1502-Y50R
sabio - NCS S3005-G80Y
latte - Flugger 4362, NCS S1505-Y50R
ashen - RAL 7035



STANDARD OPTIONS

- door leaf painted with acrylic UV varnish
- door leaf frame made of MDF
- core made of „honeycomb“
- glass pane white bark 4 mm thick

OPTIONS WITHOUT EXTRA CHARGE

- glass pane „chinchila“ or „window blind“
- ventilation sleeves
- third hinge to rebated door leaf

NOTE: To ensure highest quality of painted products, before painting process, both, door leaf and door frames are coated with special material which constitutes solid base.

REBATED DOOR LEAF

- straight edge
- 2 silver screw-in pivot hinges
- single-point mortise simple key lock, bathroom lock, cylinder lock or economic lock

NON-REBATED OPENING DOOR LEAF

(extra charge)

- edge whitout rebate
- sockets for 2 hidden recessed Estetic 80 hinges (hinges constitute a part of the door frame)
- magnetic/mechanical lock for simple key, bathroom lock, cylinder lock or economic lock in steel and black color or magnetic in white color - to choose from

SLIDING DOOR LEAF

- edge whitout rebate
- socket for hook lock and/or for handles

NOTE: Selected configurations of UNI 10 rebated model in white are available from stock.

NOTE: THE SILENT PACKAGE APPLIES TO REBATED AND NON-REBATED SINGLE LEAF DOOR.

DOOR LEAF WITH INVERTED REBATE (EXTRA CHARGE)

- active single door leaf
- straight edge
- sockets for two recessed Estetic 1821 hinges (hinges constitute a part of the door frame)
- magnetic simple key lock, bathroom lock, cylinder lock or economic lock

OPTIONS AVAILABLE WITH EXTRA CHARGE

- Silent 37dB package (dropping seal + acoustic insert) - UNI 10
 - glass pane MAT DRE, DECORMAT BROWN, DECORMAT GRAPHITE (applies to door leaf BULAJ MDF)
 - white frost VSG 22.1 safe, complex glass pane BULAJ MDF
 - stabilising insert tubular chipboard
 - core made of full chipboard
 - door leaf "90" and "100"
 - ventilation undercut
 - recuperative shortcut -8mm
 - non-rebated door leaf
 - door leaf with inverted rebate
 - cover strip for double non-rebated door leaf
 - plastic ventilation grille
 - aluminum ventilation grille
 - black fittings for rebated door leaf
 - double leaf door leaf price x2
 - it is possible to buy only steel BULAJ in black or steel color - included in the price
- NOTE:** Third Estetic 80 hinge for non-rebated doors (extra charge is added to the price of the door frame)

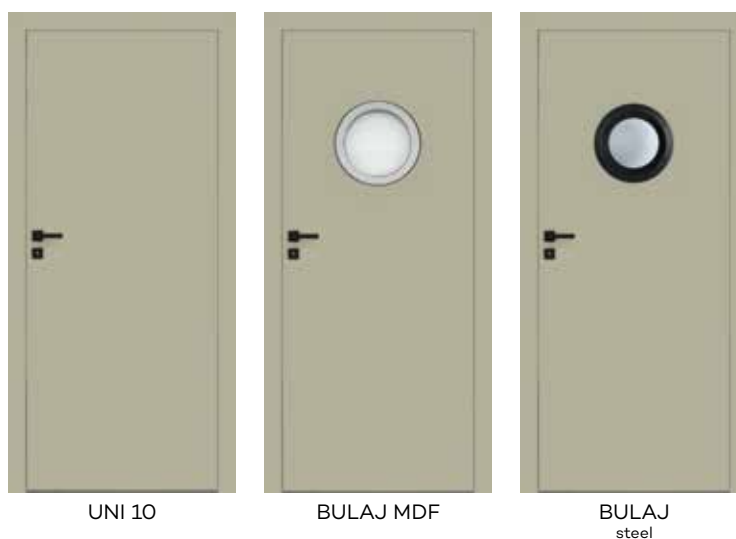
UNI MODELS

**DOBRA
CENA**

37 dB

FARGO



FARGO 30 - ashen



FARGO 10 - ashen

DECORS

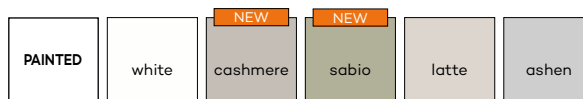

white - UV acrylic varnish - RAL 9003
cashmere - NCS S1502-Y50R
sabio - NCS S3005-G80Y
latte - Flugger 4362, NCS S1505-Y50R
ashen - RAL 7035



type of milling in
FARGO collection



STANDARD OPTIONS

- door leaf painted with acrylic UV varnish
- door leaf frame made of MDF
- core made of „honeycomb“

OPTIONS WITHOUT EXTRA CHARGE

- ventilation sleeves
- three hinges - applies to rebated door leaf

NOTE: To ensure highest quality of painted products, before painting process, both, door leaf and door frames are coated with special material which constitutes solid base.

REBATED DOOR LEAF

- straight edge
- 2 silver screw-in pivot hinges
- single-point mortise simple key lock, bathroom lock, cylinder lock or economic lock

NON-REBATED OPENING DOOR LEAF

(extra charge)

- edge whitout rebate
- sockets for 2 hidden recessed Estetic 80 hinges (hinges constitute a part of the door frame)
- magnetic/mechanical lock for simple key, bathroom lock, cylinder lock or economic lock in steel and black color or magnetic in white color - to choose from

SLIDING DOOR LEAF

- edge whitout rebate
- socket for hook lock and/or for handles

DOOR LEAF WITH INVERTED REBATE (extra charge)

- active single door leaf
- straight edge
- sockets for two recessed Estetic 1821 hinges (hinges constitute a part of the door frame)
- magnetic simple key lock, bathroom lock, cylinder lock or economic lock

OPTIONS AVAILABLE WITH EXTRA CHARGE

- Silent package 37dB (dropping seal + acoustic insert) - FARGO 10 - 60
- door leaf "90" and "100"
- tubular chipboard
- core made of full chipboard
- ventilation undercut
- recuperative shortcut -8mm
- non-rebated door leaf
- door leaf with inverted rebate
- cover strip for double non-rebated door leaf
- plastic ventilation grille
- aluminum ventilation grille
- black fittings for rebated door leaf
- double leaf door leaf price x2

NOTE: Third Estetic 80 hinge for non-rebated doors (extra charge is added to the price of the door frame)

NOTE: the Silent package applies to rebated and non-rebated single leaf door.

FARGO MODELS



FARGO 10

FARGO 20

FARGO 30

FARGO 40

FARGO 50

FARGO 60



BINITO



BINITO 20 - white

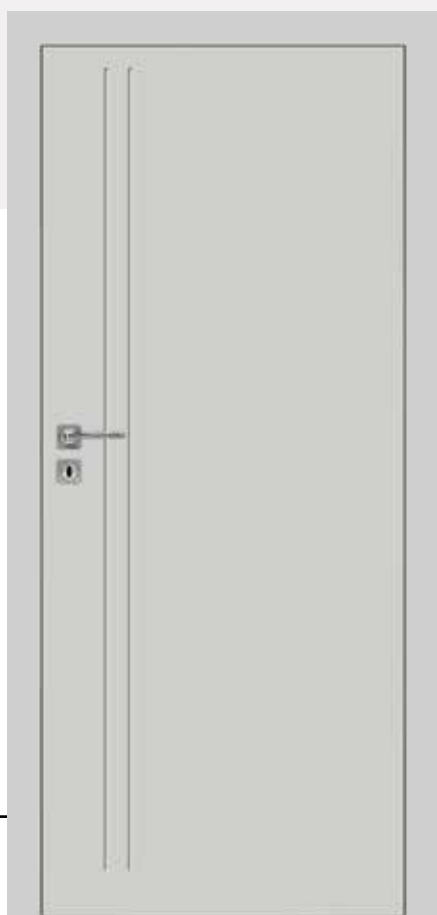

BINITO 50 - ashen



DECORS

PAINTED	white	NEW cashmere	NEW sabio	latte	ashen
---------	-------	-----------------	--------------	-------	-------

white - UV acrylic varnish - RAL 9003
cashmere - NCS S1502-Y50R
sabio - NCS S3005-G80Y
latte - Flugger 4362, NCS S1505-Y50R
ashen - RAL 7035

DOOR HANDLE WITH A BACKPLATE

The promotion applies to rebated and non-rebated BINITO collections doors. Door handle model and finish color to choose from: WEGA, ATRIA, ARCTUS, ORION, ZETA, AVIOR, MIMOSA and ALTAIR door handles and a backplate for a simple key or a cylinder insert or a bathroom lock.

The promotion lasts while stocks last.



STANDARD OPTIONS

- door leaf painted with acrylic UV varnish
- door leaf frame made of MDF
- core made of „honeycomb“
- glass pane white bark 4 mm thick

OPTIONS WITHOUT EXTRA CHARGE

- glass pane „chinchila“ or „window blind“
- ventilation sleeves
- three hinges - applies to rebated door leaf

NOTE: To ensure highest quality of painted products, before painting process, both, door leaf and door frames are coated with special material which constitutes solid base.

REBATED DOOR LEAF

- straight edge, flat glazing bar
- 2 silver screw-in pivot hinges
- single-point mortise simple key lock, bathroom lock, cylinder lock or economic lock

NON-REBATED OPENING DOOR LEAF

(extra charge)

- edge without rebate, flat glazing bar
- sockets for 2 recessed Estetic 80 hinges (hinges constitute a part of the door frame)
- magnetic/mechanical lock for simple key, bathroom lock, cylinder lock or economic lock in steel and black color or magnetic in white color - to choose from

SLIDING DOOR LEAF

- edge without rebate, flat glazing bar
- socket for hook lock and/or for handles

DOOR LEAF WITH INVERTED REBATE (EXTRA CHARGE)

- active single door leaf
- straight edge
- sockets for two recessed Estetic 1821 hinges (hinges constitute a part of the door frame)

- magnetic simple key lock, bathroom lock, cylinder lock or economic lock

OPTIONS AVAILABLE WITH EXTRA CHARGE

- Silent package 37dB (dropping seal + acoustic insert) - BINITO 10 - 90
- glass pane MAT DRE, DECORMAT BROWN, DECORMAT GRAPHITE

BINITO 11, 23

BINITO 21, 100

BINITO 24, 110

- white frost VSG 22.1 safe, complex glass pane

BINITO 11

BINITO 23

BINITO 21, 100

BINITO 24

BINITO 110

- door leaf "90" and "100"

- tubular chipboard

- core made of full chipboard

- non-rebated door leaf

- ventilation undercut

- recuperative shortcut -8mm

- door leaf with inverted rebate

- cover strip for double non-rebated door leaf

- plastic ventilation grille

- aluminum ventilation grille

- black fittings for rebated door leaf

- double leaf door

leaf price x2

NOTE: Third Estetic 80 hinge for non-rebated doors (extra charge is added to the price of the door frame)

NOTE: the Silent package applies to rebated and non-rebated single leaf door.

BINITO MODELS



BINITO 10



BINITO 20



BINITO 30



BINITO 50



BINITO 60



BINITO 70



BINITO 80



BINITO 90



BINITO 100



BINITO 110



BINITO 11



BINITO 21



BINITO 23



BINITO 24

STANDARD INVEST



steel BULAJ INVEST - honey oak



STANDARD INVEST 70 - honey oak

DECORS

CPL Laminate 1st group	white	milky white	ashen					
	CPL Laminate 2nd group	welsh oak	acacia	celini walnut	walnut	honey oak	NEW natural hickory	roasted walnut
		black ST	dark gray	concrete 2	gray oak			
FINISH	white alpine	bleached craft oak	riviera oak	rustic oak				



STANDARD INVEST

REBATED DOOR LEAVES

interior doors

STANDARD OPTIONS

- door leaf frame made of MDF
- core made of „honeycomb“
- transparent glass, thickness 4 mm

OPTIONS WITHOUT EXTRA CHARGE

- ventilation sleeves
- three hinges - applies to rebated door leaf

REBATED DOOR LEAF

- straight edge
- edge with a radius R 2.5 mm made by directforming **available in the 2nd group of CPL (rounded glazing frame in CPL laminates)**
- straight edge (**Slim frame in Finish foils**)
- 2 silver screw-in pivot hinges
- single-point mortise simple key lock, bathroom lock, cylinder lock or economic lock
- All orders in the investment standard require approval of The Investment Department. The investment standard is defined by door frame passage, with opened door leaf at 90 degree, respectively for interior doors: "80" 800 mm, "90" 900 mm.

OPTIONS AVAILABLE WITH EXTRA CHARGE

- Silent package 37dB (dropping seal + acoustic insert) - STANDARD INVEST 10
- glass pane MAT DRE (applies to door leaf) STANDARD INVEST 20, 70, 80, BULAJ MDF STANDARD INVEST 60
- stabilising insert tubular chipboard
- "100" door leaves
- ventilation undercut
- recuperative shortcut -8mm
- plastic ventilation grille
- aluminum ventilation grille
- black fittings for rebated door leaf
- it is possible to buy only steel BULAJ in black or steel color - included in the price

NOTE! Selected configurations of STANDARD INVEST 10 rebated model in alpine white are available from stock.

STANDARD INVEST MODELS



STANDARD INVEST 10



STANDARD INVEST 20



STANDARD INVEST 60



STANDARD INVEST 70



STANDARD INVEST 80



BULAJ INVEST MDF



steel BULAJ INVEST



Steel black BULAJ **



Steel BULAJ**

** only matt or transparent glass available,



STANDARD CPL



STANDARD 10 - acacia



STANDARD CPL 20 - concrete 2

DECORS

CPL Laminate 1st group	white	milky white	ashen					
CPL Laminate 2nd group	welsh oak	acacia	celini walnut	walnut	honey oak	NEW natural hickory	roasted walnut	
	black ST	dark gray	concrete 2	gray oak				



The price of the door leaf does not include the price of the door frame and handle.

STANDARD CPL

REBATED, NON-REBATED DOOR LEAVES
interior doors

STANDARD OPTIONS

- edge radius R 2.5 mm only for laminates 0.15-0.20 mm from CPL 2nd group
- straight edge for laminates 0.15-0.20 mm and 0.7 mm
- door leaf frame made of softwood
- core made of „honeycomb“
- glass pane white bark 4 mm thick
- CPL laminate 0.15 - 0.2mm or 0.7mm

OPTIONS WITHOUT EXTRA CHARGE

- glass pane „chinchila“ or „window blind“
- ventilation sleeves
- three hinges - applies to rebated door leaf

REBATED DOOR LEAF

- straight edge
- edge with a radius R 2.5 mm made by directforming method, available in the 2nd group of CPL laminates 0.15-0.20 mm
- **straight edge for laminates 0.7 mm**
- 2 silver screw-in pivot hinges
- single-point mortise simple key lock, bathroom lock, cylinder lock or economic lock
- All orders in the investment standard require approval of The Investment Department. The investment standard is defined by door frame passage, with opened door leaf at 90 degree, respectively for interior doors: "80" 800 mm, "90" 900 mm.

NON-REBATED OPENING DOOR LEAF

(extra charge)

- edge without rebate, rounded glazing frame
- sockets for 2 recessed Estetic 80 hinges (hinges constitute a part of the door frame)
- magnetic/mechanical lock with a simple key, bathroom lock, cylinder lock or economic lock

SLIDING DOOR LEAF

- edge without rebate, rounded glazing frame
- socket for hook lock and/or for handles

NOTE: colours equivalent: W0118 - WHITE

OPTIONS AVAILABLE WITH EXTRA CHARGE

- Silent package 37dB (dropping seal + acoustic insert) - STANDARD 10 CPL
- glass pane MAT DRE, DECORMAT BROWN, DECORMAT GRAPHITE (applies to door leaf)
- STANDARD 20, BULAJ MDF
- STANDARD 60
- white frost VSG 22.1 safe, complex glass pane
- STANDARD 20
- STANDARD 60
- BULAJ MDF
- stabilising insert tubular chipboard
- "100" door leaves
- door leaf "110" (only STANDARD 10)
- laminates 0.15 - 0.20 mm
- non-rebated door leaf
- upper single point mortise lock (available only in STANDARD 10 door leaf model with tubular chipboard and fixed door frame)
- plastic ventilation grille
- aluminum ventilation grille
- cover strip for double non-rebated door leaf
- ventilation undercut
- recuperative shortcut -8mm
- black fittings for rebated door leaf
- double leaf door leaf price x2
- there is possibility to purchase steel BULAJ separately
- in black or steel colour

NOTE: Third Estetic 80 hinge for non-rebated doors (extra charge is added to the price of the door frame)

0.7 mm CPL laminate is also available in the "110" door leaf width and in Standard CPL 20, 60 models, MDF BULAJ, steel BULAJ - to place an order, please contact the Customer Service Department.

STANDARD CPL MODELS



STANDARD 10



STANDARD 20



STANDARD 60



BULAJ MDF



BULAJ
steel



Steel black BULAJ **



Steel BULAJ**

** only matt or transparent glass available,



NOTE: the Silent package applies to rebated and non-rebated single leaf door.

Door leaf width: single leaf "60" ÷ "100", double leaf rebated "120" ÷ "200", double leaf non-rebated "120" ÷ "180".
Technical information: door frames: pp. 144-167, accessories: pp. 168-174 and 181, door leaves: pp. 182-195.

STANDARD

variable heights



STANDARD 10 - evoke oak



STANDARD 10 - vintage oak

DECORS

DRE CELL	white (textured)	White matt	White pine	siberian elm	sand oak	bleached oak textured	vintage oak
	walnut	NEW natur oak premium	anthracite elm	dark wenge	marrone chestnut textured	evoke oak	walnut caramel
	toffee oak* ***	light gray matt	silver				
CPL Laminate 1st group	white	milky white	ashen				
CPL Laminate 2nd group	welsh oak	acacia	celini walnut	walnut	honey oak	NEW natural hickory	roasted walnut
	black ST	dark gray	concrete 2	gray oak			

*decor available while stocks last, ***decor only in horizontal grain



STANDARD 10

REBATED, NON-REBATED DOOR LEAVES WITH VARIABLE HEIGHTS

interior doors

STANDARD OPTIONS

- door leaf frame made of softwood
- core made of „honeycomb“

OPTIONS WITHOUT EXTRA CHARGE

- ventilation sleeves

REBATED DOOR LEAF

- straight edge with the edging band
- edge with a radius R 2.5 mm made using the direcforming method

available in the 2nd group of CPL

- 3 silver screw-in pivot hinges
- single-point mortise simple key lock, bathroom lock, cylinder lock or economic lock

NON-REBATED OPENING DOOR LEAF

(extra charge)

- edge whitout rebate
- sockets for 2 hidden concealed Estetic 80 hinges (non-rebated door frames are equipped with hinges)
- magnetic/mechanical lock with a simple key, bathroom lock, cylinder lock or economic lock

OPTIONS AVAILABLE WITH EXTRA CHARGE

- Silent 37dB package (1983) (dropping seal + acoustic filling) - STANDARD 10
 - Silent 37dB package (2110 and 2240) (dropping seal + acoustic filling) - STANDARD 10
 - filling: tubular chipboard (1983)
 - tubular chipboard (2110 and 2240)
 - door leaf "90" - "100" (1983) DRE - CELL
 - door leaf "90"- "100" (2110 and 2240) DRE-CELL
 - door leaf "90" - "100" (1983) DRE - CELL
 - door leaf "100" (2110 and 2240) DRE - CPL
 - non-rebated door leaf
 - ventilation undercut
 - plastic ventilation grille
 - aluminum ventilation grille
 - cover strip for double non-rebated door leaf
 - black fittings for rebated door leaf
 - double leaf door leaf price x2
- NOTE: Third Estetic 80 hinge for non-rebated doors (extra charge is added to the price of the door frame)

CPL 0.7 mm laminate also available - to place an order, please contact the Customer Service Department.

Door leaf, dependent on selected height option - 1983 mm, 2110 mm or 2240 mm is dedicated to door frames with three hinges in corresponding heights.

NOTE: colours equivalent: W0118 - WHITE

STANDARD 10 MODELS



STANDARD 10
height 1983

STANDARD 10
standard
height

STANDARD 10
height 2110

STANDARD 10
height 2240



DOORS WITH HIDDEN FRAME



Hidden doors mounted on an aluminum frame offer a minimalist design that blends perfectly into the wall, giving the impression of a coherent space. The option of finishing with paint or wallpaper allows for full personalization, while ready-made color variants or veneers offered by DRE ensure easy and quick adjustment to various interior styles.



SARA ECO 2 - primer, wall and door leaf painted with blackboard paint.

PROFI PRO



PROFI - primer (painted in wall color)



PROFI - white door leaf with aluminum frame

DOOR LEAF DECORS

PAINTED	white	white - UV acrylic varnish - RAL 9003
	primed	



NON-REBATED - OPENED OUTWARDS AND INVERTED REBATE - OPENED INWARDS

PROFI system door with an aluminum door frame and a 50 mm thick door leaf is an innovative solution that allows for creative interior design with the usage of invisible doors, with the option of finishing the door leaf surface in the same colors as the walls.

PROFI DOOR STRUCTURE INCLUDES:

Aluminum door frame, "invisible" after assembly process, build in the wall or overlaid with plasterboards. After detailing process, the only visible part is the rebate of the door frame, prepared for future painting, e.g. in the colors of the walls.

Non-rebated panel construction door leaf and inverted rebate in two finishing options:

- Wide surfaces of the door leaf primed and ready for painting or wallpapering (e.g. in the color of the walls). The edges of the leaf are covered with the edge band that can be also painted. Painting should be done on your own or you shall choose a painted decor.
- Wide surfaces of the door leaf and edges painted with white acrylic UV varnish.

OPTIONS AVAILABLE WITH EXTRA CHARGE

- ventilation undercut
- dropping seal
- **Silent 37dB** package (dropping seal + acoustic filling) - Standard 2043
- **Silent 37dB package** (package (dropping seal + acoustic filling) - Standard 2240
- extra charge for the third Estetic 80 hinge

Inverted rebate door frame profile



Non-rebated door frame profile



SARA ECO 2



SARA ECO 2 - standard 240 painted in the color of the wall



SARA ECO 2 - sand oak door leaf with aluminum frame

DOOR LEAF DECORS

PAINTED	white	NEW cashmere	NEW sabio	latte	ashen			
	3D	grand oak	elm	american walnut	ebony*	Polish oak 3D		
DRE CELL1	white (textured)	White matt	White pine	siberian elm	sand oak	bleached oak textured	vintage oak	
	walnut	NEW natur oak premium	anthracite elm	dark wenge	marrone chestnut textured	evoked oak	walnut caramel	toffee oak*, ***
DRE CELL2	silver	light gray matt	warm gray matt	cashmere matt	sage oak (textured)	NEW sage matt	dark olive matt	dark blue matt
	DRE CELL2	antique copper**	concrete oxide**					
CPL	black ST							
DECOR	primed							

white - UV acrylic varnish - RAL 9003
 cashmere - NCS S1502-Y50R
 sabio - NCS S3005-G80Y
 latte - Flugger 4362, NCS S1505-Y50R
 ashen - RAL 7035

*while stock last

**decor with black edge of the door leaf

*** decor available only in horizontal wood grain



SARA ECO 2

NON-REBATED DOOR LEAVES WITH INVERTED REBATE

interior doors

NON-REBATED - OPENED OUTWARDS AND INVERTED REBATE - OPENED INWARDS

Sara Eco 2 door leaf is an innovative solution for creative interior design with the use of "invisible" doors. This unique construction gives possibility to finish surface of door leaf in the colors of the walls.

CONSTRUCTION OF SARA ECO 2 DOOR LEAF COMPRISES OF:

Aluminum door frame, "invisible" after assembly process, build in the wall or overlaid with plasterboards. After detailing process, the only visible part is the rebate of the door frame, prepared for future painting, e.g. in the colors of the walls.

Non-rebated panel construction door leaf and inverted rebate in two finishing options:

- wide surfaces of door leaf are primed and ready for painting or paperhanging (e.g. in the colour of the walls). Edges of the leaf are covered with a paintable edge band. Painting is to be done at one's discretion or optional choose painted decor.
- Wide door leaf surfaces covered with foils from DRE-Cell, 3D, CP black ST groups or with painting foil in the group of painted decors, the edges of the door leaf covered with the edging in the color of the foil (except for antique copper and concrete oxide colors).

OPTIONS AVAILABLE WITH EXTRA CHARGE WITH PRIMER

- ventilation undercut
- recuperative shortcut -8mm
- tubular chipboard in standard 202
- tubular chipboard in 220 standard
- tubular chipboard in standard 240
- solid chipboard in standard 202
- solid chipboard in standard 220
- solid chipboard, standard 240

STANDARD OPTION

- door leaf frame made of softwood
- sockets for 2 or 3 recessed hinges, new hinges with increased load capacity up to 60 kg are used in white and black door frame colors
- core made of „honeycomb“
- white or silver simple key magnetic lock, toilet lock, cylinder lock or economic lock

OPTIONS AVAILABLE WITH EXTRA CHARGE IN DRE-CELL, 3D AND PAINTED

- ventilation undercut
- recuperative shortcut -8mm
- plastic ventilation grille
- aluminum ventilation grille
- dropping seal
- tubular chipboard in standard 202
- tubular chipboard in 220 standard
- tubular chipboard in standard 240
- solid chipboard in standard 202
- solid chipboard in standard 220
- solid chipboard, standard 240

Price of the door frame includes 2 or 3 hidden concealed hinges. Note: in the option with a tubular chipboard or solid chipboard in standard 202, there are required 3 hinges.

NOTE: Sara ECO 2 door leaves in primer with DRE aluminum frames in aluminum and white are available from stock in selected configurations.

AVAILABLE COLOURS OF ALUMINUM DOOR FRAMES



aluminum



White
RAL 9003



black

SLIDING SYSTEMS, FOLDING



Sliding door systems save space, making them ideal for smaller rooms, and provide a modern and elegant look. Folding doors, on the other hand, allow for easy opening even in narrow spaces and at the same time offer more flexible room divisions, which increases the functionality of the interior.



ESTRA 5 - white matt, NT (on a tunnel) sliding system

SLIDING SYSTEM

NS (on a wall), NT (on a tunnel)
interior doors

DRE WALL-MOUNTED SLIDING SYSTEM

It is designed for single or double leaf interior doors in a sliding version. It can be used for doors in our offer, in the following finishes: DRE-Cell, 3D foil, CPL laminates, as well as painted doors, except for the following collections: Enter, Enter Akustik, Solid, Solid RC2, Forca B, fire resistant doors, glass doors and doors with variable heights.

In our sale offer there are available two different types of sliding system:

NS - system mounted directly on the wall
NT - sliding system mounted together with adjustable tunnel

There are two options of NT sliding system:

- mounted together with adjustable tunnel with 63 mm architrave
- mounted together with adjustable tunnel with 80 mm architrave

The NS sliding system includes: a guide (SN 150, 180, 200) with fittings, a spacer strip, a cover and a fender beam (the beam is only for single-leaf doors, for doors with a lock there

NS system - mounted directly on the wall

NT system - installed using an adjustable tunnel

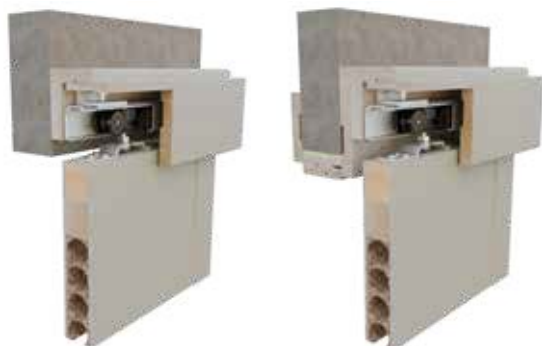

is a milling for a catch in the beam).

In the system mounted with adjustable tunnel, NT, set contains 2 additional 16 mm spacing boards with cross-sections adapted to the width of architraves (63 mm or 80 mm). There are differences in cross-sections of NS and NT masking element.

To complete entire set of sliding doors it is necessary to purchase sliding leaf unit in following dimensions:

Single leaf door: „60“, „70“, „80“, „90“, „100“

Double leaf door: „2x60“, „2x70“, „2x80“, „2x90“, „2x100“

Door leaf might be equipped with sockets for lock and/or handle - those accessories must be purchased separately.

In the system mounted with adjustable tunnel NT, it is necessary to purchase adjustable tunnel separately.

CPL 2nd group laminate applies to the natural halifax oak laminate with horizontal graining.

ACCESSORIES

- Square handle 1 pc.
- Rectangular handle 1 pc.
- Hook lock with key, WC, with two square handles
- hook lock with key, WC, for cylinder lock, with two rectangular handles
- One set of door handle for single door leaf consist of 2 pcs.
- Cylinder insert 20/20

NOTE: The masking strip and guide for double systems are obtained by connecting two elements from a single system.



SYSTEMS SLIDING SYSTEM

of GLASS DOORS TP, TO
interior doors

SPAZIO SLIDING SYSTEM FOR GLASS DOORS.

Made of anodized aluminum, it is a complete solution designed for a finished jamb. The set includes a running rail with a straight or oval blend and elements designed for hanging a sliding glass panel and a bottom limiter.

There are two options of Spazio System (only difference is in the shape of external blende):

- Spazio TP – with straight blende
- Spazio TO – with oval blende

To complete the whole system it is recommended to buy glass door leaf in sliding version from Galla collection. There is designed for this solution round handle.

OPTIONS AVAILABLE WITH EXTRA CHARGE

- door handle (two-sided)

Note: There is no possibility to make ventilation option.

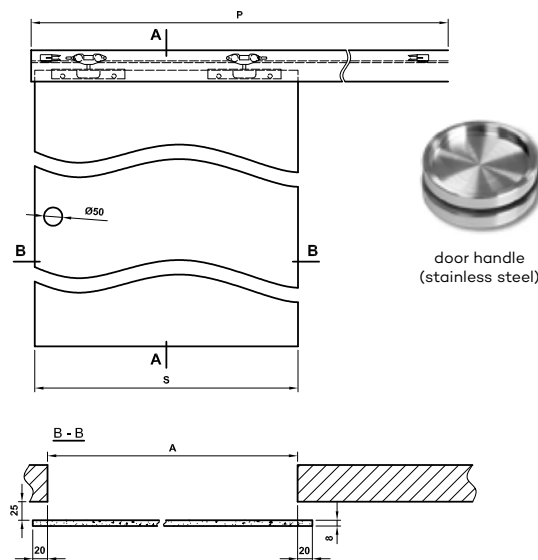
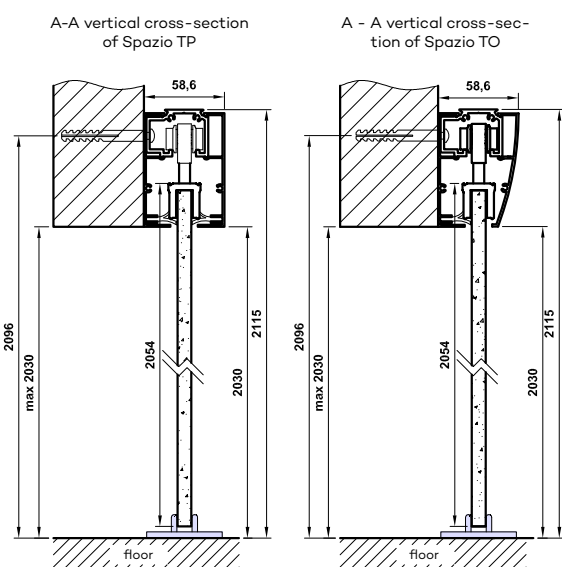

door handle (stainless steel)

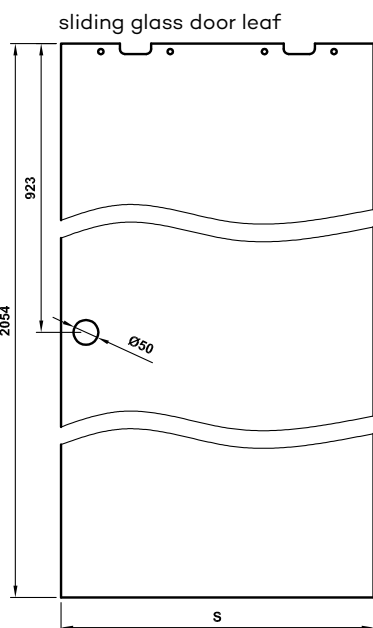

Dimensions

	S	A	P	S - width of door leaf unit A - width of wall passage P - lenght of guide channel
"60"	630	590	1340	
"70"	730	690	1540	
"80"	830	790	1740	
"90"	930	890	1940	

Spazio TO



Spazio TP



SPAZIO CD WALL MOUNTED

SLIDING SYSTEM

interior doors



SPAZIO CD

On-wall mounted sliding system with anodized guide channel and rectangular blende. Is designated for panel doors and frame construction doors.

WHOLE SET COMPRISES OF:

- guide channel with side caps
- system sliding trolleys
- door leaf hangers
- bottom stopper
- assembly kit (screws and bolts)

To complete the system, you need to buy a sliding door leaf from our wide range in a version with a handle. The handle must be purchased separately. Shell handle p.118

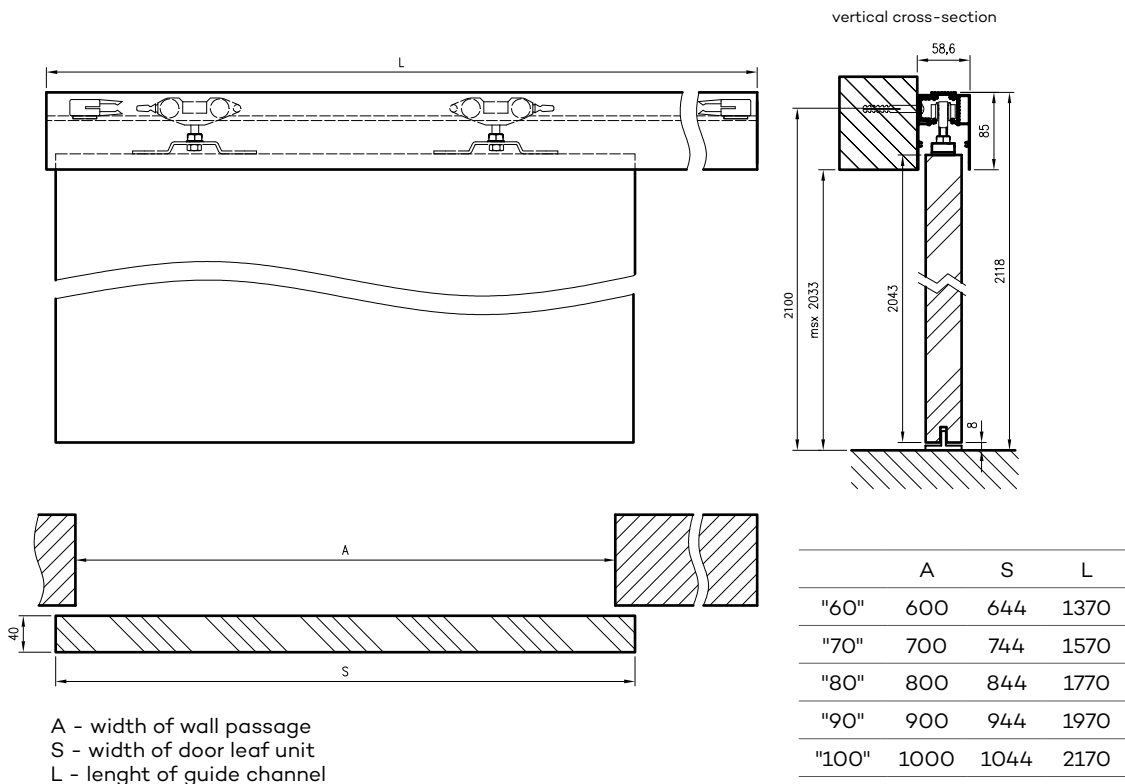

SYSTEMS B01 FRAMELESS CASSETTE

SLIDING DOOR LEAF
interior doors

DOOR FRAMELESS CASSETTE B01

Door frameless cassette with the possibility of assembly and disassembly of the door leaf after assembly and processing of the cassette. The assembly of the system involves embedding the cassette in the construction of profiles used to build a plasterboard wall (or other structure) with a thickness of:

- 100 mm for the B01 100 mm door frameless cassette
- 125 mm for the B01 125 mm door frameless cassette

Then covering wide surfaces with 12.5 mm plasterboards (plasterboards must be purchased separately) and finishing these surfaces.

LIST OF DOOR COLLECTIONS AND MODELS AVAILABLE IN THE DOOR FRAMELESS CASSETTE SYSTEM B01:

ESTRA; VERANO; ENA; TRIESTA; SOLTE; REVA; FOSCA; NESTOR; AURI; ELSA; PREMIUM; PIANO; SCALA; VERSO; BERGE; EVEN; NOVA 10; RIVIA 10, RIVIA 60-130; GALERIA ALU 10, 20, 30, 50, 60; FINEA 10, 40; STANDARD 10, UNI 10; FARGO 10-60; BINITO 10-90. The leaves have additional milling on the upper edge. Door leaves with locks and panel construction door leaves with glazing and panels cannot be used for B01 frameless cassettes.

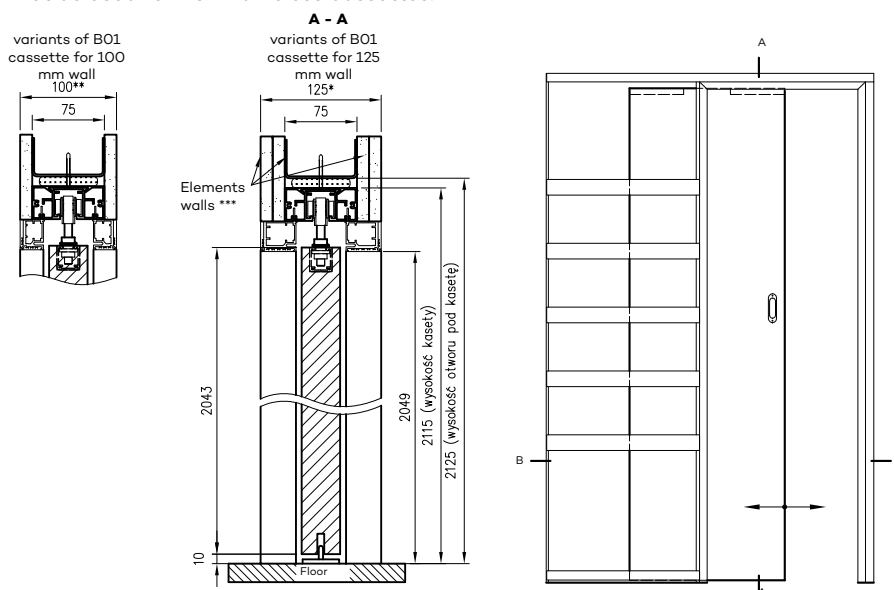

Width	S	A	C	D	G
60	644	626	1360	1380	659
70	744	726	1560	1580	759
80	844	826	1760	1780	859
90	944	926	1960	1980	959
100	1044	1026	2160	2180	1059

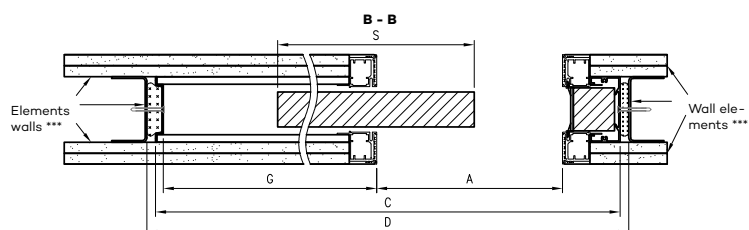

- S - door leaf width
- A - width of the door frame passage
- C - total width of cassette
- D - width of walls passage prepared for cassette
- G - depth of ready cassette

- * variant of B01 cassette for 125 mm wall
- ** variant of B01 cassette for 100 mm wall
- *** wall elements are not components of the product

PA CASSETTE SYSTEM



PA sliding system doors hidden in the wall (pocket system) - STANDARD 10 vintage oak



STANDARD 10 - PA cassette sand oak

DECORS

PAINTED	white	NEW cashmere	NEW sabio	latte	ashen		
	3D	grand oak	elm	american walnut	ebony*	Polish oak 3D	
DRE CELL	white (textured)	White matt	White pine	siberian elm	sand oak	bleached oak textured	vintage oak
	walnut	NEW natur oak premium	anthracite elm	dark wenge	marrone chestnut textured	evoked oak	walnut caramel
silver	light gray matt	warm gray matt	cashmere matt	sage oak (textured)	NEW sage matt	dark olive matt	dark blue matt
	concrete oxide*	antique copper*	black matt 2				

*decor available while stocks last, ***decor only in horizontal grain

white - UV acrylic varnish - RAL 9003
 cashmere - NCS S1502-Y50R
 sabio - NCS S3005-G80Y
 latte - Flugger 4362, NCS S1505-Y50R
 ashen - RAL 7035

PA DOOR FRAME CASSETTE

SLIDING DOOR LEAVES

interior doors

PA DOOR FRAME CASSETTE

System assembly involves embedding the cassette in the construction of profiles used to build a plasterboard wall (or other construction) with a thickness of:

- 100 mm for the PA 100 mm door frame cassette
- 125 mm for the PA 125 mm door frame cassette

Next, wide surfaces construction with the usage of 12.5mm plasterboards (plasterboards must be purchased separately) and finishing these surfaces and assembly of Tunnel Cassette Cover.

In addition, the 100 mm PA cassettes cannot be used with door leaves with locks and panel construction doors with glazing or panels

THE SET INCLUDES:

- cassette elements made of aluminum elements and additional assembly accessories
- elements which allows to decorate build in sliding system - so called tunnel cassette cover with architraves 80 mm wide

NOTE: VETRO A, VETRO D, VETRO D2, VETRO E and VETRO B door leaves with a width of "70" do not fit the 100 mm and 125 mm PA cassettes.

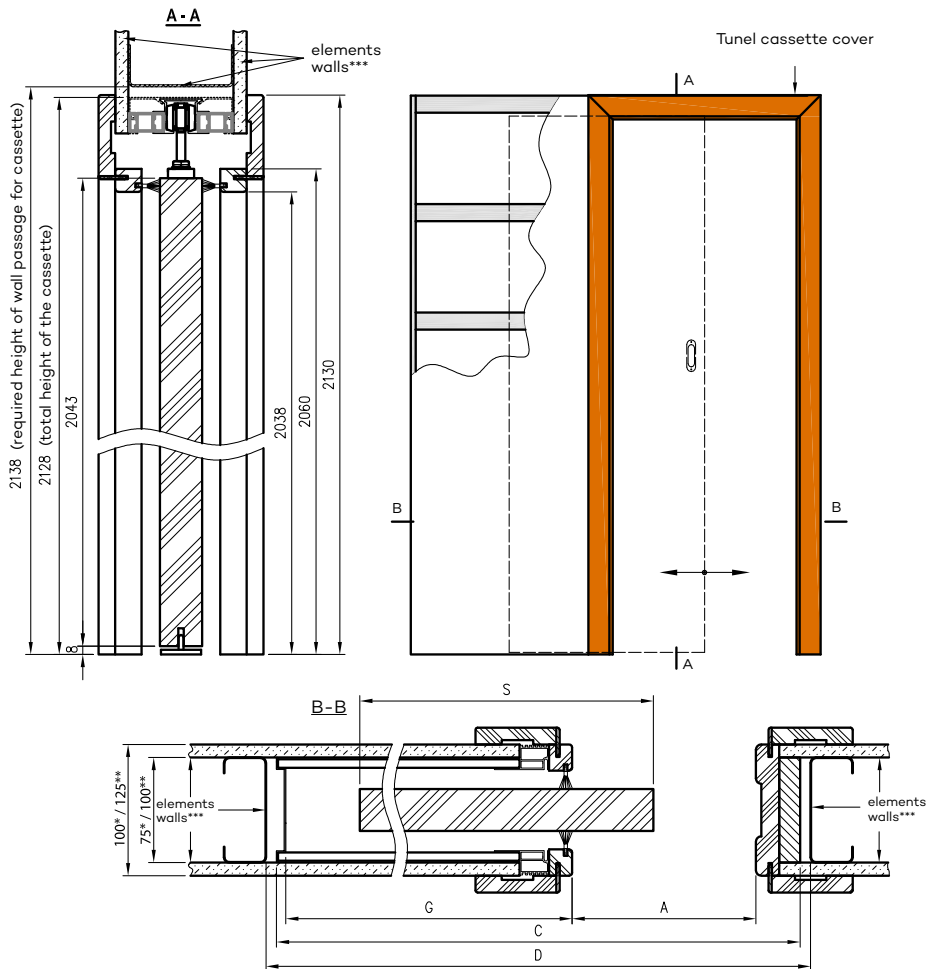

Width	A	S	C	D	G
60	600	644	1310	1330	656
70	700	744	1510	1530	756
80	800	844	1710	1730	856
90	900	944	1910	1930	956
100	1000	1044	2110	2130	1056

* dimensions refer to the 100mm PA cassette

** dimensions refer to 125mm PA cassette

*** wall elements are not components of the product

C - total width of cassette

D - width of walls passage prepared for cassette

G - depth of ready cassette

FOLDE



folding doors FOLDE 10 - white matt



FOLDE - light grey matt

DECORS

3D	grand oak	elm	american walnut	ebony*	Polish oak 3D		
DRE CELL	white (textured)	White matt	White pine	siberian elm	sand oak	bleached oak textured	vintage oak
	NEW						
walnut	natur oak premium	anthracite elm	dark wenge	marrone chestnut textured	evoked oak	walnut caramel	toffee oak* ***
silver	light gray matt						

*decor available while stocks last, ***decor only in horizontal grain



FOLDING DOORS FOLDE

interior doors

In folding doors during opening process of door leaf unit, doors fold into position parallel to each other. The complete set of folding doors comprises of:

- two-elements door leaf connected by 3 hidden recessed hinges
- adjustable door frame for folding doors

STANDARD OPTIONS

- door leaf frame made of softwood
- core made of „honeycomb“
- straight edge
- single-point mortise simple key lock, bathroom lock, cylinder lock or economic lock
- 3 hidden recessed ISTAR hinges installed between two-elements of door leaf unit

OPTIONS AVAILABLE WITH EXTRA CHARGE

- core made of tubular chipboard
- door leaf "90" and "100"

NOTE: There is no possibility to shorten door leaf.

Cross-section of folding doors in closed position*
(right doors, left doors are mirror reflection)

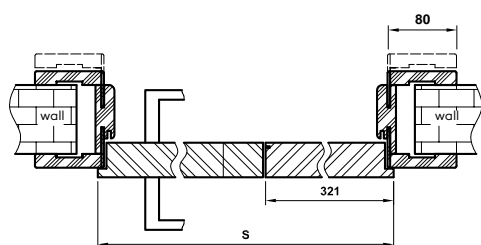

vertical cross-section

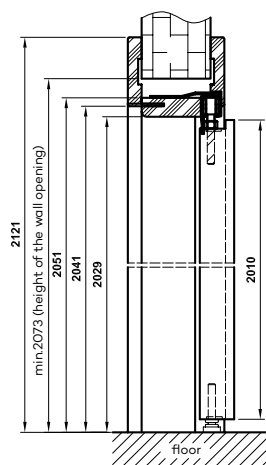

Cross section of folding door in open position*

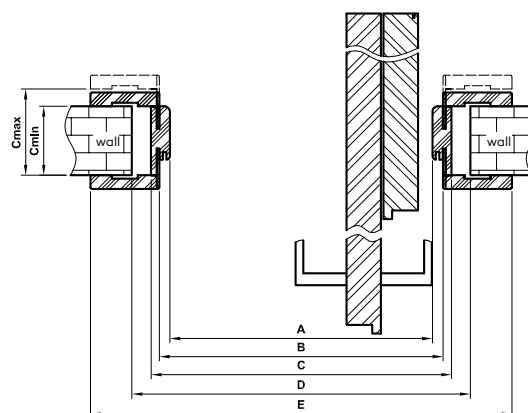

*NOTE: When doors are fully opened, the door fittings slightly reduce the clear opening by approx. 10 cm. (this value doesnt take into account door handle)

Dimensions

	S	A	B	C	D	E
"80"	844	806	830	850	880	990
"90"	944	906	930	950	980	1090
"100"	1044	1006	1030	1050	1080	1190

D - required width of wall opening

prices of adjustable door frames for folding doors with T80 architrave

SIDE PANELS

Rebated panel construction
interior doors

STANDARD OPTIONS

- door leaf frame made of softwood
- core made of „honeycomb”
- glass pane 4 mm thick: white bark, "window blind", CHINCHI-LA, MAT DRE, DECORMAT BROWN or DECORMAT GRAPHITE.
- 2 silver screw-in pivot hinges
- latch strike plate and two flush bolts
- to choose from: straight edge*, flat glazing frame or black Slim glazing frame

OPTION WITHOUT EXTRA CHARGE

- third hinge
- black glass pane frame Slim

OPTIONS AVAILABLE WITH EXTRA CHARGE

- white frost VSG 22.1 safe, complex glass pane

SIDE PANEL 30

SIDE PANEL 40

SIDE PANEL 41

- core made of tubular chipboard
 - black fittings for rebated door leaf
 - door frame for door leaf with side panel +30%
- Side panel it is passive rebated door leaf with "40" width and 40 mm thickness, with glazing or without glazing option, in uniform wood grain. Side panels can be paired with interior rebated door leaf in the following combination: „60+40”; „70+40”; „80+40”; „90+40”; „100+40”.

SIDE PANEL 10 can be used for rebated interior doors. SIDE PANEL 30 is adapted to the ARTE 10-30 and STANDARD 30 models. SIDE PANEL 40 is adapted to the ARTE 40, 50, 90 models; STANDARD 40, DECO collection. SIDE PANEL 41 is adapted to the MODERN 30, PLUS 30 models.

To make the best possible match of side panel to door leaf unit, besides selection of model, it is necessary to choose wright colour, type of the edge and number of hinges.

NOTE: There is no possibility to shorten side panels.



Side panel 10 Side panel 30 Side panel 40 Side panel 41

DRE CELL	white (textured)	White matt	White pine	siberian elm	sand oak	bleached oak textured	vintage oak	walnut	NEW natur oak premium	anthracite elm	dark wenge	marrone chestnut textured
evoked oak	walnut caramel	toffee oak***	silver	light gray matt								
3D	grand oak	elm	american walnut	ebony*	Polish oak 3D							
CPL Laminate	white	milky white	ashen	welsh oak	acacia	celini walnut	walnut	honey oak	NEW natural hickory	roasted walnut	black ST	dark gray
concrete 2	gray oak											

*decor available while stocks last, ***decor only in horizontal grain

SIDE PANELS

Rebated frame construction
interior doors

STANDARD OPTIONS

- stiles made of wood-based panels
- glass pane 4 mm: MAT DRE, decormat brown, decormat graphite or transparent glass
- 3 silver screw-in pivot hinges
- latch strike plate and two flush bolts
- straight edge

OPTIONS AVAILABLE WITH EXTRA CHARGE

- door frame for door leaf with side panel +30%

NOTE: Price of side panel is equal to the price of corresponding door leaf model.

Possibility of making side panels "40" for all models of frame doors included in the presented collections in the combinations "60+40"; "70+40"; "80+40"; "90+40"; "100+40"

NOTE: There is no possibility to shorten side panels.



side panel PREMIUM (edge straight) DRE-Cell 3D foil	side panel PIANO (edge straight) DRE-Cell 3D foil	side panel FOSCA (edge straight) DRE-Cell 3D foil	side panel SCALA A (edge straight) DRE-Cell 3D foil	side panel SCALA B (edge straight) DRE-Cell 3D foil	side panel ELSA (edge straight) DRE-Cell 3D foil	side panel AURI (edge straight) DRE-Cell 3D foil	side panel REVA (edge straight) DRE-Cell 3D foil	side panel SOLTE (edge straight) DRE-Cell 3D foil
---	---	---	---	---	--	--	--	---

white (textured)	White matt	White pine	siberian elm	light gray matt	sand oak	bleached oak textured	vintage oak	natur oak premium	NEW	evoked oak	walnut caramel	marrone chestnut textured	DRE CELL
										anthracite elm	dark wenge	black matt 2	
							grand oak	elm	american walnut	ebony*	Polish oak 3D		3D

*while stock last

TRANSOM LIGHTS



ESTRA 6 - sidelight - black matt2



STANDARD 10 and side lights - vintage oak

POSSIBLE CONFIGURATIONS

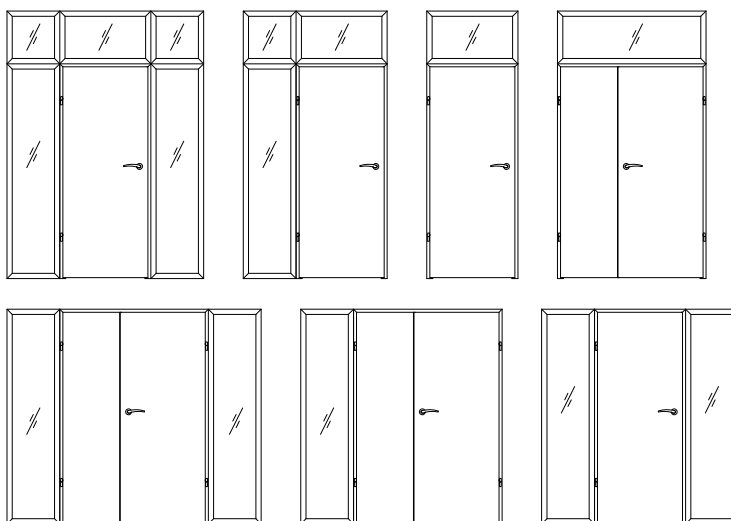

The price of the transom lights/sidelights applies to one running meter of the circumference measured on the outside of the transom lights/sidelight, and is an approximate price. In order to calculate the exact price of the finished product, please contact the Investment Department.

To place an order please contact the Investment Department - phn. 55 236 42 59.

NOTE: height of the sidelight is adapted to the standard height of the fixed door frame. Therefore, we do not recommend shortening door frames in configuration with the sidelight.

TRANSOM LIGHTS / SIDELIGHTS

Transom lights/ sidelights are fixed, unopenable, glazed partition between rooms or spaces that may constitute an independent structure or a supplement for interior doors (except for glass doors) with a fixed door frames. Transom lights/sidelights are manufactured and delivered as a set of components ready for assembly. Set contains the following:

- two horizontal and two vertical main beams
- set of cover and instalation strips
- set of gaskets
- main beam couplers

Transom lights/sidelights are used in interior doors with a fixed door frames and they come in the following decors DRE-Cell, 3D , CPL laminate 0,15-0,20 mm and painted.

NOTE: Our product doesn't come with the glass pane, which should be purchased separately. We recommend to use tempered glass pane with a thickness of 4 mm. Assembly of transom lights/sidelights should be performed once the "wet" construction are completed.

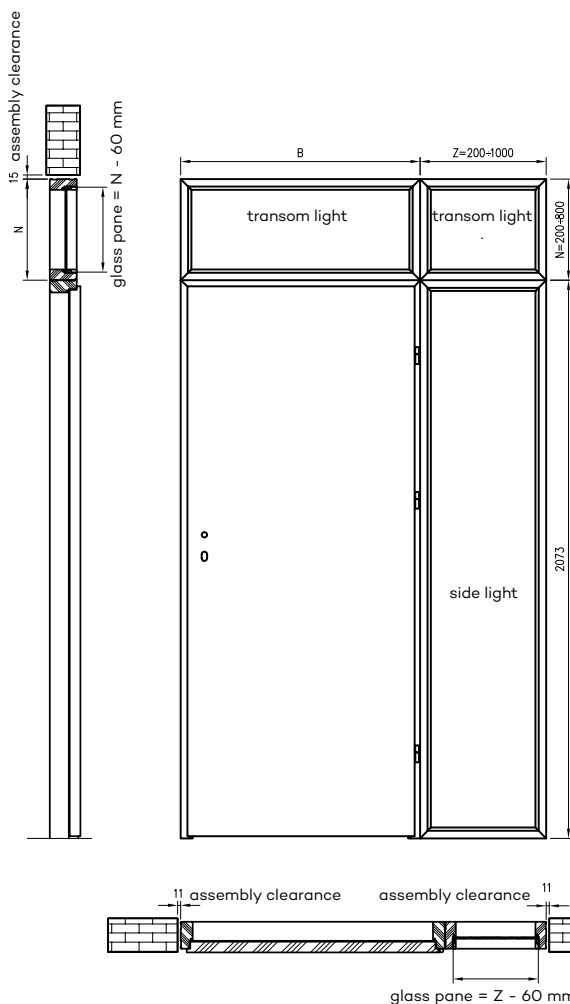
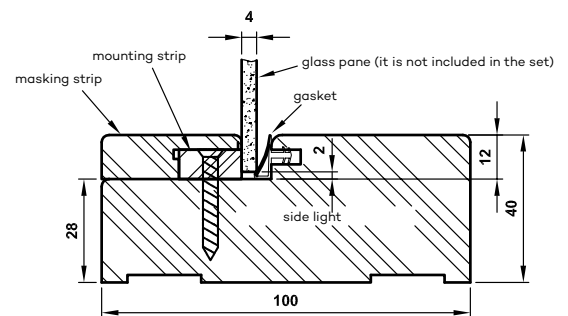

Fig. A cross-section of the transom light/sidelights



Dimensions of transom lights/side lights

range of products	height total	width total	length of the perimeter
side light	2073 mm	Z	$2 \cdot 2073 + 2 \cdot Z$
side light	N	Z	$2 \cdot N + 2 \cdot Z$
transom light	N	B	$2 \cdot N + 2 \cdot B$

available options of transom lights heights

„N” = 200-800 mm.

available options of the width of transom and side lights

„Z” = 200-1000 mm.

Width of the upper "B" transom lights is adjusted to the width of the fixed door frames; the available options of the width of fixed door frames; available options of the widths can be found in the following tables:

The transom lights are mounted on the single-leaf door frame

	"60"	"70"	"80"	"90"	"100"	"110"
B	688	788	888	988	1088	1188

TRANSOMS MOUNTED WITH THE DOOR FRAME IN DOUBLE-LEAF DOORS

	„100d"	„110d"	„120"	„130"	„140"	„150"	„160"	„170"	„180"	„190"	„200"
B	1123	1223	1323	1423	1523	1623	1723	1823	1923	2023	2123



TECHNICAL DOORS INTERIOR ENTRANCE

We present interior entrance and technical doors, ideally suited to apartments, offices and specialist rooms. We offer products that meet the highest standards of quality, functionality and safety.



Forca - Welsh oak

ENTER / SOLID



ENTER 0 - elm



ENTER 0 - acacia

DECORS

DRE CELL 1st gr.	White matt	light gray matt	silver				
DRE CELL 2nd gr.	white (textured)	White pine	siberian elm	sand oak	bleached oak textured	vintage oak	toffee oak**, ***
	walnut	NEW natur oak premium	anthracite elm	dark wenge	marrone chestnut textured	evoked oak	walnut caramel
3D	grand oak	elm	american walnut	ebony**	Polish oak 3D		
CPL Laminate	white	milky white	ashen	dark gray	concrete 2	gray oak	welsh oak
	acacia	celini walnut	walnut	honey oak	NEW natural hickory	roasted walnut	black ST

** decor available while stocks last, *** decor only with horizontal grain



ENTER

ENTER / SOLID

REBATED DOOR LEAVES,

interior entrance

STANDARD OPTIONS

- door leaf frame made of MDF additionally reinforced with two flat metal bars
- core made of tubular chipboard
- external HDF board - flat or with decorative milling .
- 3 silver screw-in pivot hinges
- straight edge or R 2.5 mm edge (in CPL laminates except white, milky white, ashen)

REBATED DOOR LEAF MODEL ENTER:

- bottom deadbolt lock adapted for door lock cylinder
- upper deadbolt lock adapted for door lock cylinder
- Door leaves are available in the investment dimension "90E" (door frame passage with opened door leaf at 90 degree = 900mm)

REBATED DOOR LEAF SOLID

- multipoint mortise lock
- hinges reinforced with anti-thrust bolts
- Door leaves are available in the investment dimension "90E" (door frame passage with opened door leaf at 90 degree = 900mm)

APPLICATION

Door leaf ENTER and SOLID can be used as internal entrance door in multifamily and in public utility buildings.

CONSTRUCTION

Construction door leaf frame is made of MDF, additionally reinforced with two flat metal bars. Core is made of perforated chipboard. Door leaf unit has increased acoustic insulation (Rw=32dB). External HDF board is ennobled with DRE-Cell veneer - optional - flat finishing or decorative milling.

For Enter/Solid 0 models, 0.7 mm CPL laminate is also available - to place an order, please contact the Investment Department.

OPTIONS AVAILABLE WITH EXTRA CHARGE

- viewfinder - included separately
- digital viewfinder DDS1 - included separately
- digital viewfinder DDS2 - separately
- stainless steel threshold - width 70 mm
- resignation from the second lock (Enter)
- dropping seal
- black hinges for ENTER rebated door leaf

NOTE: ENTER 0 and SOLID 0 - door leaves in CPL laminates as a standard with an edge radius R 2.5 mm except for white, milky white, gray.

For ENTER/SOLID collection door leaves we recommend fixed door frame ENTER/SOLID or steel door frames .

ENTER/SOLID MODELS



ENTER/ SOLID
0



ENTER/ SOLID
1



ENTER/ SOLID
2



ENTER/ SOLID
3



ENTER/ SOLID
4



ENTER/ SOLID
5



ENTER/ SOLID
6



ENTER/ SOLID
7



ENTER/ SOLID
8



ENTER/ SOLID
9



ENTER/ SOLID
10



ENTER/ SOLID
11

Door leaves width: single leaf "80"÷"100".

Technical information: door frames: pp. 144-167, accessories: pp. 168-174 and 181, door leaves: pp. 182-195.

ENTER / SOLID



SOLID 23 - acacia



ENTER 0 - concrete 2

DECORS

DRE CELL 1st gr.	White matt	light gray matt	silver				
DRE CELL 2nd gr.	white (textured)	White pine	siberian elm	sand oak	bleached oak textured	vintage oak	toffee oak**, ***
	walnut	NEW natur oak premium	anthracite elm	dark wenge	marrone chestnut textured	evoked oak	walnut caramel
3D	grand oak	elm	american walnut	ebony**	Polish oak 3D		
CPL Laminate	white	milky white	ashen	dark gray	concrete 2	gray oak	welsh oak
	acacia	celini walnut	walnut	honey oak	NEW natural hickory	roasted walnut	black ST

** decor available while stocks last, *** decor only with horizontal grain



ENTER / SOLID

REBATED DOOR LEAVES,
interior entrance

STANDARD OPTIONS

- door leaf frame made of MDF additionally reinforced with two flat metal bars
- core made of tubular chipboard
- external HDF board - flat or with decorative milling .
- 3 silver screw-in pivot hinges
- straight edge or R 2.5 mm edge (in CPL laminates except white, milky white, ashen)

REBATED DOOR LEAF MODEL ENTER:

- bottom deadbolt lock adapted for door lock cylinder
- upper deadbolt lock adapted for door lock cylinder
- Door leaves are available in the investment dimension "90E"
- (door frame passage with opened door leaf at 90 degree = 900mm)

REBATED DOOR LEAF SOLID

- multipoint mortise lock
- hinges reinforced with anti-thrust bolts
- Door leaves are available in the investment dimension "90E"
- (door frame passage with the door leaf open at an angle of 90 degrees = 900 mm)

APPLICATION

Door leaf ENTER and SOLID can be used as internal entrance door in multifamily and in public utility buildings.

For ENTER/SOLID collection door leaves we recommend fixed door frame ENTER/SOLID or steel door frames .

DOOR FRAME CONSTRUCTION

Construction door leaf frame is made of MDF, additionally reinforced with two flat metal bars. Core is made of perforated chipboard. Door leaf unit has increased acoustic insulation (Rw=32dB). External HDF board is ennobled with DRE-Cell veneer - optional - flat finishing or decorative milling.

NOTE: In models 19 and 20, the cladding is glued into strips with variable grain.

NOTE: In models 21-23, 8 mm wide inserts are made, placed flush with the door surface on both sides

NOTE: ENTER 21-23 and SOLID 21-23 models - door leaves in CPL laminates and edge with R 2,5 mm radius as a standard.

ENTER/SOLID MODELS



ENTER/ SOLID
12



ENTER/ SOLID
13



ENTER/ SOLID
14



ENTER/ SOLID
15



ENTER/ SOLID
16



ENTER/ SOLID
17



ENTER/ SOLID
18



ENTER/ SOLID
19



ENTER/ SOLID
20



ENTER/ SOLID
21



ENTER/ SOLID
22



ENTER/ SOLID
23

Door leaves width: single leaf "80"÷"100".

Technical information: door frames: pp. 144-167, accessories: pp. 168-174 and 181, door leaves: pp. 182-195.

SOLID RC2



SOLID RC2 - gray oak



SOLID RC2 - acacia

DECORS

CPL Laminate	white	milky white	ashen	dark gray	concrete 2	gray oak	welsh oak
	acacia	celini walnut	walnut	honey oak	NEW natural hickory	roasted walnut	black ST
Steel door frame colors	white mat RAL 9003	light gray matt RAL 7047	dark gray matt RAL 7024	brown matt RAL 8017	white semi-gloss RAL 9003	light gray semi-gloss RAL 7047	DARK GRAY semi-gloss RAL 7024
	brown semi-gloss RAL 8017	beige semi-gloss RAL 1001	black matt RAL 9005	Black semi-gloss RAL 9005			

Door frames colours are in two gloss scale (matt/low structure, semi gloss/plain).



STANDARD OPTION:

- door leaf frame made of soft wood
- core made of full chipboard
- straight edge
- multipoint mortise lock
- anti-thrust bolts
- 3 triple hinges
- HDF external board with aluminum sheet

SOLID RC2 doors have an acoustic insulation class of $R_w=32\text{dB}$ and burglary resistance of class RC2 according to PN-EN 1627:2012, provided that the door leaf is completed with a steel door frame, a steel threshold and a separately purchased, dedicated set of fittings: door handle, long backplate and cylinder inserts.

APPLICATION

Door leaf SOLID RC2 can be used as internal entrance door in multifamily buildings and in public utility buildings. It can be used together with door frames:

- OSS (steel fixed door frame) information - page 158
- OSR (steel adjustable door frame) information and prices - page 161
- OSH (steel hybrid door frame) information - page 164

OPTIONS AVAILABLE WITH EXTRA CHARGE

- viewfinder - separately
- "100" door leaves
- steel threshold
- ONTARIO door handle
- ONTARIO backplate
- patent insert (price for 2 pc)

OPTIONS WITHOUT ADDITIONAL CHARGE

Doors available in the investment dimension "90E" (passage-way in the door frame with the door leaf open at an angle of 90 degrees = 900 mm)

SOLID RC2 MODELS



threefold hinge E878



SOLID RC2

ATHOS



ATHOS 10 - white



ATHOS 10 - walnut

DECORS

CPL Laminate	white	milky white	ashen	dark gray	concrete 2	gray oak	welsh oak
	acacia	celini walnut	walnut	honey oak	NEW natural hickory	roasted walnut	



ATHOS FIRE RESISTANT DOORS

TECHNICAL REBATED DOORS,
interior entrance

ATHOS TECHNICAL DOORS MEET THE FOLLOWING REQUIREMENTS:

- fire resistance class: EI30 with a steel door frame
- fire resistance class: EI30 with a wooden door frame
- smoke proof class: Sa, S₂₀₀
- mechanical resistance class: 3
- sound insulation class: RW=32 dB
- acoustic insulation class: Rw = 37 dB with a wooden door frame and wooden threshold

APPLICATION

Interior entrance fire resistant doors, are used in residential housing, public utility buildings and collective residential buildings, as well as commercial and technical premises.

STANDARD OPTION

- door leaf frame made of soft wood
- core made of full chipboard
- straight edge
- single-point mortise lock adapted for cylinder lock
- 3 triple hinges
- anti-theft pins

DOOR FRAMES

- steel fixed door frame p. 158
- steel adjustable door frame p. 161
- steel hybrid door frame p. 164
- wooden door frame p. 135, technical drawings p. 186

CONSTRUCTION

OD ATHOS wooden door frame is made of glued pine wood, covered with CPL O, 15-0.2 mm laminate on the exposition side. Frame beams, with a fixed width of 100mm, are cut at an angle of 90 °. An intumescent gasket with fire-resistant properties is glued in the channel, milled in the notch of the beams.

APPLICATION

OD ATHOS wooden door frames are dedicated to Athos door leaves, which as a set, installed in accordance with the National Technical Assessment No. 2018/0633, they constitute a partition with fire resistance EI 30. Moreover, equipped with a fixed threshold, they meet the acoustic insulation criteria in accordance with the class Rw = 37 dB, and in the configuration with a dropping seal, without a fixed threshold, Rw = 32 dB

Technical information, drawings, dimension tables p. 186

OPTIONS AVAILABLE WITH EXTRA CHARGE

- DORMA TS-71 selfcloser
- DORMA TS-90 selfcloser
- GEZE TS 2000 selfcloser
- door leaf "100" (for 0.7 mm laminate)
- door leaves "100" "110" (for 0.15-0.2 mm laminates)
- viewfinder
- wooden threshold

In order to comply with the conditions of the National Technical Assessment, doors with fire resistance EI 30 should be equipped with a selfcloser.

ATTENTION: The price of the leaf does not include the price of a steel frame or a wooden frame.

Door leaves with a width of "110" in 0.7 mm laminates available after individual pricing by the Contract Department.

WOODEN DOOR FRAME for ATHOS

SET CONTAINS

- Main beams (lintel, latch plate beam with the main lock catch and main beam with the hinges with milled holes for the yokes and three-part hinges and mounted anti-theft bolt sockets), rebate gasket, three hinges (middle part of the three-part hinge) + 3 hinge yokes, a set of elements to be assembled door frame according to the attached instructions. The door frames are packed in cardboard boxes.

Assortment of wooden frames:

- OD ATHOS - for Athos door with a fixed threshold
- OD ATHOS UO - for Athos doors with a dropping seal
-
-

FORCA

ANTI BURGLARY, REBATED, FIRE-RESISTANT DOORS

interior entrance



FORCA 10 - gray oak



FORCA TECHNICAL DOORS MEET THE FOLLOWING REQUIREMENTS:

- anti-burglary class: RC3 (according to PN-EN 1627:2012)
- fire resistance class: EI₂30
- smoke proof class: Sa, S₂₀₀
- mechanical resistance class: 3
- acoustic insulation class: Rw = 37 dB with a steel frame and a metal threshold

APPLICATION

Interior entrance, fire resistance and anti-burglary doors are used in residential housing, public utility buildings and collective residential buildings as well as commercial and technical premises. Doors are sold only as a complete set with metal door frame, metal threshold, door handle, backplate and two cylinder lock inserts.

STANDARD OPTION

- door leaf frame made of soft wood
- core made of full chipboard
- straight edge
- steel strings
- 5-point mortise lock
- 3 triple hinges
- anti-theft pins

DOOR FRAMES

- steel fixed door frame p. 158
- steel adjustable door frame p. 160
- steel hybrid door frame p. 164

OPTIONS AVAILABLE WITH EXTRA CHARGE

- steel threshold
- handle-handle F1 color*
- long backplate F1 color*
- patent cylinder x 2 pcs.
- DORMA TS-71 selfcloser
- DORMA TS-90 selfcloser
- GEZE TS 2000 selfcloser
- door leaf "100"
- viewfinder

In order to meet the requirements of the National Technical Assessment for doors with fire resistance EI 30 and burglary resistance - a door closer and DIVA handle with a rosette should be used. Photo of the handle and rosette - p. 173.

NOTE: The price of the door leaf should be increased by the price of steel door frame, steel threshold, door handle, backplate and two pcs. of cylinder lock inserts.

* - F8 black anode color, available for contract orders, after consultation and individual price verification with the Investment Department.

DECORS



FORCA B

ANTI BURGLARY, REBATED DOORS
interior entrance

FORCA B TECHNICAL DOORS MEET THE FOLLOWING REQUIREMENTS:

- anti-burglary class: RC3 (according to PN-EN 1627:2012)
- mechanical resistance class: 3
- acoustic insulation class: $R_w = 37$ dB with a steel frame and a metal threshold

APPLICATION

Interior entrance, fire resistance and anti-burglary doors are used in residential housing, public utility buildings and collective residential buildings as well as commercial and technical premises. Doors are sold only as a complete set with metal door frame, metal threshold, door handle, backplate and two cylinder lock inserts.

STANDARD OPTION

- door leaf frame made of soft wood
- core made of full chipboard
- straight edge
- steel strings
- 5-point mortise lock
- 3 triple hinges
- anti-theft pins

DOOR FRAMES

- steel fixed door frame p. 158
- steel adjustable door frame p. 160
- steel hybrid door frame p. 164

OPTIONS AVAILABLE WITH EXTRA CHARGE

- steel threshold
- handle-handle F1 color*
- long backplate F1 color*
- patent cylinder x 2 pcs.
- door leaf "100"
- viewfinder

NOTE: The price of the door leaf should be increased by the price of steel door frame, steel threshold, door handle, backplate and two pcs. of cylinder lock inserts.

* - F8 black anode color, available for contract orders, after consultation and individual price verification with the Investment Department.



FORCA B - Welsh oak

DECORS

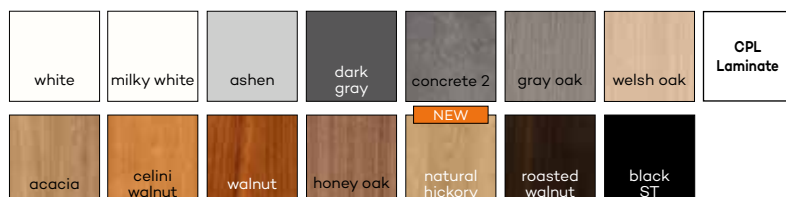

OLIMP



OLIMP 10 - white



OLIMP 10 - gray oak

DECORS

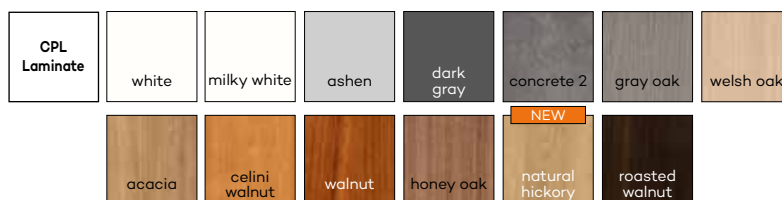

OLIMP MODELS



OLIMP 20



OLIMP 30



OLIMP 40



NOTE: In door leaf with fire-resistance EI30 there are used three triple hinges, while in door leaf with fire resistance EI60 there are used VX7939 hinges.



Acoustic sound insulation class for single leaf door $R_w=32$ dB

. Width of door leaf: single leaf "80"÷"110".

FIRE RESISTANT OLIMP DOORS

TECHNICAL REBATED DOORS,
internal entrance of HALSPAN system

STANDARD OPTIONS

- core made of Halspan chipboard 44 mm in EI30 or 54 mm in EI 60 with additional pine wood strips attached circumferentially
- straight edge, rounded glazing frame, transparent fire-resistant glass (variable width depending on the size of the door leaf)
- intumescent smoke-proof gasket
- 3 hinges/cylinder lock
- dropping seal

OPTIONS AVAILABLE WITH EXTRA CHARGE

- viewfinder
- DORMA TS-71 selfcloser
- DORMA TS-90 selfcloser
- GEZE TS 2000 selfcloser
- fire resistance ventilation grille.

APPLICATION

Fire-resistance doors are used as interior entrance doors in residential housing, public utility buildings and collective residential buildings.

In order to comply with the conditions of the National Technical Assessment self closer should be applied in doors with fire-resistance EI30 and EI60.



self closer
GEZE TS2000



self closer
DORMA TS-71



self closer
DORMA TS-90 impuls



fire-resistant ventilation grille.

OLIMP DOOR FRAMES

ANTI BURGLARY, REBATED, FIRE-RESISTANT DOORS

interior entrance

STEEL FIXED DOOR FRAME for OLIMP EI 60

DOOR FRAME CONSTRUCTION

Steel door frame made of 1.5 mm thick structural carbon steel sheet, welded construction, powder coated.

APPLICATION

Door frame is applied to the interior entrance fire-resistance doors OLIMP EI60.

STANDARD OPTIONS

- 3 hinges
- gasket with enhanced flame-resistance properties

AVAILABLE COLOURS

Door frame is powder coated in two gloss scale (matt / low structure or semi-gloss / plain). There are available colours:



*** beige color available only in semi-gloss

										
RAL 9005	RAL 9005	RAL 9003	RAL 7047	RAL 7024	RAL 8017	RAL 9003	RAL 7047	RAL 7024	RAL 8017	RAL 1001

Technical information, drawings, dimension tables p.187

FIRE-RESISTANT WOODEN DOOR FRAME for OLIMP EI 30, EI 60

CONSTRUCTION

Fixed wooden door frame with a cross-section of 54x100 mm (54x120mm for Olimp EI 60 doors) made of coniferous plywood laminated with a 0.2mm CPL laminate in the color of the door leaf.

APPLICATION

The door frame is used for interior fire-resistant entrance doors:

OD OLIMP EI30 wooden door frame - for Olimp EI 30 doors

OD OLIMP EI60 wooden door frame - for Olimp EI 60 doors

STANDARD OPTIONS

- 3 hinges
- gasket with enhanced flame-resistance properties
- latch strike plate
- mounting kit

AVAILABLE COLOURS



Technical information, drawings, dimension tables p.186

ENTER ACOUSTIC Rw 32 dB

REBATED DOORS

interior entrance

ENTER ACOUSTIC TECHNICAL DOORS MEET THE FOLLOWING REQUIREMENTS:

- mechanical resistance class: 3
- sound insulation class Rw = 32dB

APPLICATION

Door leaf ENTER ACOUSTIC are designed to be used as interior entrance door in multifamily buildings and in public utility buildings

STANDARD OPTION:

- door leaf frame made of MDF additionally reinforced with two flat metal bars
- core made of tubular chipboard
- flat external HDF board
- dropping seal
- 3 silver screw-in pivot hinges
- R2.5mm edge (available only in CPL laminates, except for white, milky white and gray laminates) or straight edge
- bottom deadbolt lock adapted for door lock cylinder
- Doors available in the investment dimension "90E" (passageway in the frame with the door leaf open at an angle of 90 degrees = 900 mm)

DOOR FRAMES:

- steel hybrid door frame p. 164
- steel adjustable door frame p. 161
- steel fixed door frame p. 158
- fixed rebated door frame page 144
- adjustable door frame with architrave T80, T63 page 146

OPTIONS AVAILABLE WITH EXTRA CHARGE:

- Viewfinder - supplied separately
- door leaves "110" except for 0.7 mm laminates
- black fittings for rebated door leaf

Door leaves with a width of "110" in 0.7 mm laminates available after individual pricing by the Contract Department.



ENTER O AKUSTIK - natural hickory

DECORS

				White matt	light gray matt	silver	DRE CELL 1st gr.
white (textured)	White pine	siberian elm	sand oak	bleached oak textured	vintage oak	toffee oak**, ***	DRE CELL 2nd gr.
walnut	NEW natur oak premium	anthracite elm	dark wenge	marrone chestnut textured	evoke oak	walnut caramel	
		grand oak	elm	american walnut	ebony**	Polish oak 3D	3D
white	milky white	ashen	dark gray	concrete 2	gray oak	welsh oak	CPL Laminate
acacia	celini walnut	walnut	honey oak	NEW natural hickory	roasted walnut	black ST	



Galla



GALLA 1 grooved transparent



GALLA 2 - sandblasted glass transparent stripes

DECORS



GALLA 1
transparent



GALLA 1
decormat



GALLA 1
decormat brown



GALLA 1
decormat graphite

NEW

NEW

NEW

NEW



GALLA 14
transparent



GALLA 15
transparent



GALLA 14
grooved



GALLA 15
grooved



APPLICATION

Glass door leaf are used as interior doors in residential housing, public utility buildings and collective residential buildings.

The leaf is a glass pane, made of safe, uniform tempered glass, 8 mm thickness, with holes for mounting:

- hinges and lock in the opening doors
- round door handle and hardware adapted for sliding system door leaf

SELECTION OF LOCKS FOR GLASS DOORS

Glass door locks are universal, they can be configured for left or right doors. In the case of locks in the "WC" version (with a bathroom knob) - the term "left" or "right" refers to the direction of door opening.

OPTIONS AVAILABLE WITH EXTRA CHARGE

- ventilation undercut in the opening doors (in "80" and "90" meet ventilation requirements)

Galla doors have different glass sides (does not apply to Galla 1 transparent) **OBVERSE**

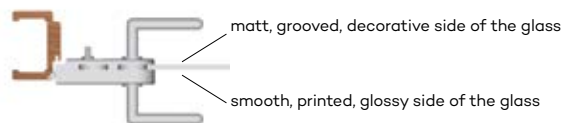

REVERSE

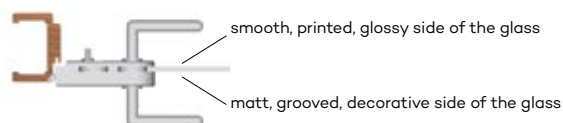

Fig. 1-2 Bathroom door opening, select left lock

fig. 1 right door leaf /blockade outside

Fig. 2 left door / lock on outside

Fig. 3-4 Door opening to the corridor, select the right lock

fig. 3 right door leaf/blockade inside

fig. 4 left door leaf/blockade inside

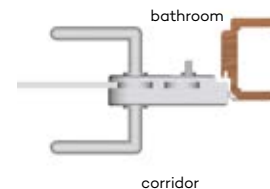
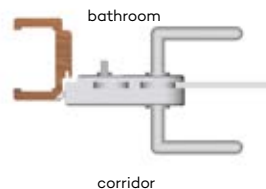
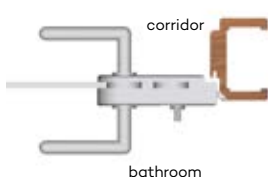
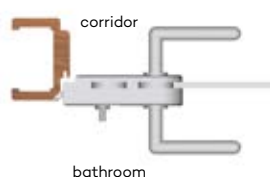

HARDWARE



silver lock



silver lock toilet***



silver lock simple key lock



silver lock cylinder lock**



silver hinge



steel lock



steel lock ***



steel lock simple key lock



steel lock cylinder lock**



steel hinge



black lock



black lock ***



black lock simple key lock



black lock cylinder lock**



hinge black

$$\boxed{\text{cena kompletu}} = \boxed{\text{cena tafli szklanej}} + \boxed{\text{cena ościeżnicy}} + \boxed{\text{cena kpl. okuć}}$$

** It is necessary to purchase cylinder insert 21/26 separately (see details in the above table)

*** Toilet lock - selection of toilet lock see details above

DOOR FRAMES



Door frames are the perfect complement to door leaves, combining aesthetic and visual values as well as technical functionality, ensuring durability, stability and a consistent appearance of our doors.



UNI 10 - white with angle panel

FIXED REBATED

DOOR FRAMES

CONSTRUCTION

Fixed door frame is made of high-quality wood-based panels and is covered with ecological, wood-like decorative DRE-Cell foil, 3D foil, CPL laminate 0.15 - 0.2 mm, Finish foil or painted. The door frame has a fixed width of 100 mm.

APPLICATION

Fixed door frame can be used in the following types of doors:

- ENTER entrance doors (equipped with 3 \varnothing 13,5 mm hinges and additional upper latch plate)
- SOLID entrance doors (equipped with 3 \varnothing 13,5 mm hinges and 4 hooks for the latch and latches of the flat multi-point lock)
- glass doors ("OPC" they are equipped with two hinges \varnothing 15 mm, special latch plate and rubber seal strip)
- other rebated doors (using 2 or 3 hinges \varnothing 13.5 mm, 3 hinges for frame construction and panel construction doors with a width of "90" and wider)

For the fixed and fixed SOFT door frames we use masking architraves.

THE SET CONTAINS

Main beam (one horizontal and two vertical elements), door seal, a set of hinges, all necessary components for the installation of door frames in accordance with the supplied instruction. Door frames are packed in cardboard boxes.



Fixed door frame



fixed door frame SOFT

OP vertical cross-section for rebated door leaf

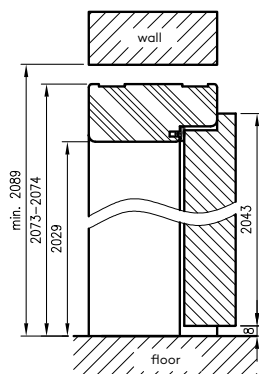

OP vertical cross-section for glass doors

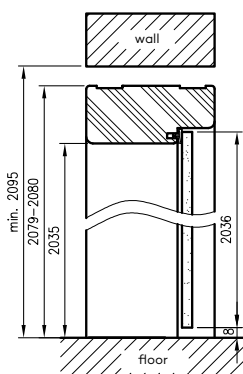

OP Horizontal cross section

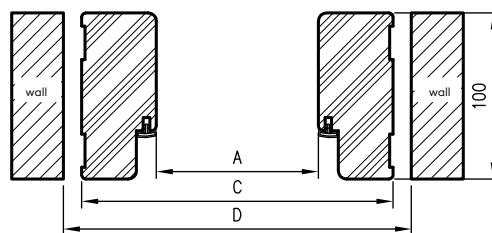

required height of wall passage 2089 mm (2095 mm for glass doors)

OPTIONS AVAILABLE WITH EXTRA CHARGE

- ENTER door frame (with deadbolt catch)
- SOLID door frame
- door frame for double leaf doors: +30%

for single-leaf doors

	A	C	D
"60"	600	688	712
"70"	700	788	812
"80"	800	888	912
"90"	900	988	1012
"90E"	904	992	1016
"100"	1000	1088	1112
"110"	1100	1188	1212

* door frames for glass doors with width "60"- "90"
D - required width of wall passage

for rebated door leaf double-leaf doors

	A	C	D
"100d"	1035	1123	1147
"110d"	1135	1223	1247
"120"	1235	1323	1347
"130"	1335	1423	1447
"140"	1435	1523	1547
"150"	1535	1623	1647
"160"	1635	1723	1747
"170"	1735	1823	1847
"180"	1835	1923	1947
"190"	1935	2023	2047
"200"	2035	2123	2147

FIXED DOOR FRAMES

NON-REBATED



CONSTRUCTION

Fixed non-rebated door frame is made of high-quality wood-based board and it is coated with ecological, wood-like decorative DRE-Cell veneer, 3D veneer, 0,15 - 0,20 mm CPL or painted.

Door frames has fixed width of 100 mm.

APPLICATION

Fixed non-rebated door frame can be applied to all DRE collections which are available in non-rebated option.

SET CONTAINS

Main beam (one horizontal and two vertical elements), door seal, a set of hinges, all necessary components for the installation of door frames in accordance with the supplied instruction. Door frames are packed in cardboard boxes.

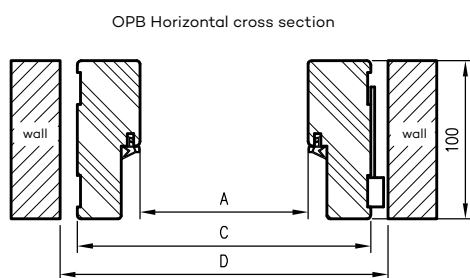

D - required wall opening 2097 mm

OPB vertical cross-section

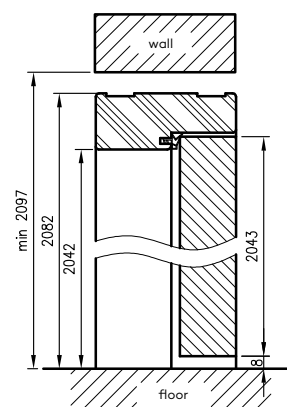

OPTIONS AVAILABLE WITH EXTRA CHARGE

- Price of the double-leaf door frame: + 50% (if 3 hinges are used, there is extra charge)
- Additional payment for the third Estetic 80 hinge

for double-leaf doors

	A	C	D
„120“	1274	1354	1380
„130“	1374	1454	1480
„140“	1474	1554	1580
„150“	1574	1654	1680
„160“	1674	1754	1780
„170“	1774	1854	1880
„180“	1874	1954	1980

for single-leaf doors

	A	C	D
„60“	627	707	730
„60N“	607	687	710
„70“	727	807	830
„70N“	707	787	810
„80“	827	907	930
„80N“	807	887	910
„90“	927	1007	1030
„90N“	907	987	1010
„100“	1027	1107	1130
„100N“	1007	1087	1110

Prices include 2 hinges with assembly plates.
2nd group CPL - CPL laminate natural halifax oak.

„xN“ - width standard for selected single-leaf non-rebated panel construction door leaves

ADJUSTABLE DOOR FRAMES

REBATED WITH ARCHITRAVE T80 OR T63

CONSTRUCTION

The adjustable door frame with T80 or T63 architrave is equipped with architraves with small rounding radii of the cross profile. It is made of high-quality wood-based board. On the exposure side it is completely covered with a wood-like DRE-Cell Decor decorative foil, 3D foil, CPL laminate 0.15 - 0.2 mm thick or painted**. Its design allows for use on walls with a thickness of 60 - 320 mm. Connection at an angle of 90°^{about} is available with T80 angle in color **white matt, light grey matt, cashmere matt, warm grey matt, dark olive matt, dark blue matt, sage oak, black matt 2, white acrylic UV painted, white pine, sand oak, vintage oak, Polish oak 3D**.

**NOTE: To ensure the highest quality of painted door frames, before painting process they are coated with special material which constitutes solid base.

APPLICATION

Adjustable door frame can be applied for:

- interior door leaves - rebated and for glass door leaves (ORC)
- ENTER entrance door (includes 3 pcs. of hinges ø 13.5 mm, additional catch - extra charge)

SET CONTAINS

Main beam (one horizontal and two vertical elements together with masking elements), door seal, set of hinges, all necessary components for the installation of door frames in accordance with the supplied instruction. Door frames are packed in cardboard boxes. Door frames used as a set with frame construction doors and door frames with size "90" and wider, should be equipped with three hinges. Door frames for glass door "ORC" are equipped with two hinges ø 15 mm, special latch plate and rubber seal strip.

OPTIONS AVAILABLE WITH EXTRA CHARGE

Price of adjustable door frame for double leaf door: +30%

The door frame for wall thickness 060-075 has got a shallower milling on the movable architrave side

during assembly it is necessary to shorten the tongue of the architrave.

- Extra charge for a 90° connection angle in white matt, light grey matt, cashmere matt, warm grey matt, dark olive matt, dark blue matt, sage oak, black matt 2, white acrylic UV varnish, white pine, sand oak, vintage oak, Polish oak 3D -
- Extra charge for reinforcement for self closer applies to door frames with a connection angle of 45° -



Selected configurations of adjustable rebated door frames are available from stock in the following colours: evoke oak, white matt, alpine white, white acrylic UV varnish.



OR (adjustable rebated door frame) with T63



OR (adjustable rebated door frame) with T80

ADJUSTABLE DOOR FRAMES

REBATED WITH ARCHITRAVE T80 OR T63

OR/ORC cross-section with T63 architrave

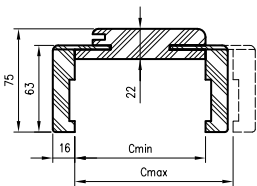

OR/ORC cross-section with T80 architrave

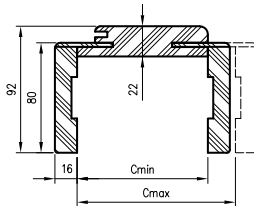

vertical cross-section of rebated door leaf with OR

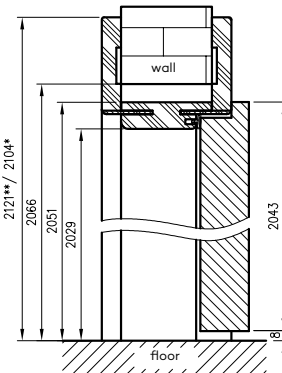

OR/ORC horizontal cross-section

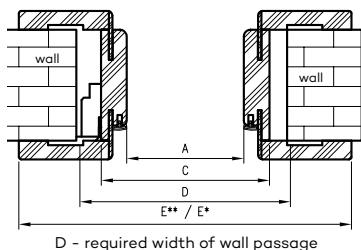

Adjustable door frame connection at an angle of 90° T80 architrave

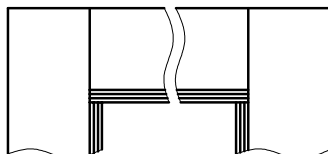

90° angle connection available in white matt, light grey matt, cashmere matt, warm grey matt, dark olive matt, dark blue matt, sage oak (structure), matt black 2, acrylic UV painted white, white pine, sand oak, Polish oak 3D, vintage oak.

vertical cross-section of glass doors with ORC (adjustable door frame for glass doors)

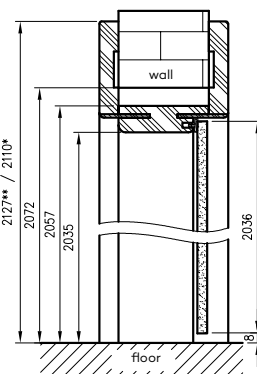

required wall passage height 2066 mm (2072 mm for glass doors)

for double-leaf doors

	A	C	D	E**	E*
100d	1035	1079	1115	1219	1185
110d	1135	1179	1215	1319	1285
120	1235	1279	1315	1419	1385
130	1335	1379	1415	1519	1485
140	1435	1479	1515	1619	1585
150	1535	1579	1615	1719	1685
160	1635	1679	1715	1819	1785
170	1735	1779	1815	1919	1885
180	1835	1879	1915	2019	1985
190	1935	1979	2015	2119	2085
200	2035	2079	2115	2219	2185

* dimension refer to door frame with T63 architrave

** dimension refer to door frame with T80 architrave

for single-leaf doors

	A	C	D	E**	E*
60	602	646	680	786	752
70	702	746	780	886	852
80	802	846	880	986	952
90	902	946	980	1086	1052
90E	906	950	984	1090	1056
100	1002	1046	1080	1186	1152
110	1102	1146	1180	1286	1252

2nd group of CPL - natural halifax oak laminate.
Black ST decor only available with T80 architrave.

ADJUSTABLE DOOR FRAMES

NON-REBATED WITH ARCHITRAVE T80 OR T63

CONSTRUCTION

The adjustable, non-rebated door frame is made of high-quality wood-based board. From the exposure side it is covered entirely with a wood-like decorative foil DRE-Cell Decor, 3D foil, CPL laminate or painted**. Its construction is adapted to a door leaf thickness of 40 mm and allows for use in walls with a thickness of 75 - 320 mm. In color **white matt, light grey matt, cashmere matt, warm grey matt, dark olive matt, dark blue matt, sage oak**

(structure), matt black 2, acrylic UV painted white, white pine, sand oak, vintage oak, Polish oak 3D, white lacquered, black lacquered, decors from the LUX and WOOD collections possible selection of beam connection angle at 90 degrees with T80 architrave.

**NOTE: To ensure the highest quality of painted and lacquered door frames, before varnishing or painting process they are coated with special material which constitutes solid base.

APPLICATION

The adjustable non-rebated door frame with Estetic 80 hinges is applicable to all DRE collections in the non-rebated version with Estetic 80 hinges.

SET CONTAINS

Main beam (one horizontal and two vertical elements) with wide angular architrave (80 mm) with small rounding angles of the cross-section profile (R2), door seal, a set of hinges, all necessary components for the installation of door frames in accordance with the supplied instruction. Door frames are packed in cardboard boxes.



EXTRA CHARGE OPTIONS

Prices include 2 hinges with assembly plates.

- Price of a door frame for double doors: +50% (additional charge when using 3 Estetic 80 hinges)
- Extra charge for third Estetic 80 hinge
- Price of a door frame for double doors: +50% (additional charge when using 3 plate hinges)
- Extra charge for a 90° connection angle in white matt, light grey matt, cashmere matt, warm grey matt, dark olive matt, dark blue matt, sage oak
- (structure), black matt 2, white acrylic UV varnish, white pine, sand oak, Polish oak 3D, vintage oak, white varnish, black varnish and decors from the LUX, WOOD collection, acrylic laminates (standard gloss, metallic gloss, standard matt, xtreme matt)
- Extra charge for reinforcement for the self closer applies to door frames with a connection angle of 45°

ADJUSTABLE DOOR FRAMES

NON-REBATED WITH ARCHITRAVE T80 OR T63

ORB cross-section 095-300

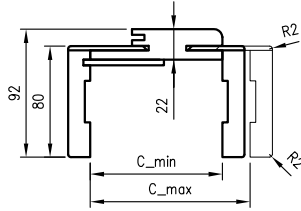

ORB cross-section 075

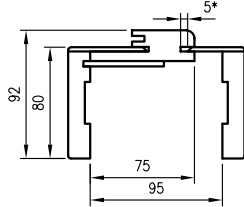

ORB horizontal cross-section

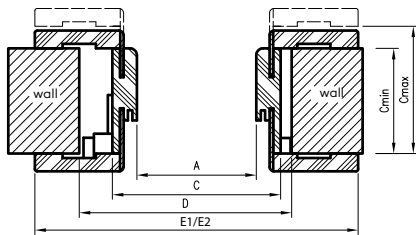

Vertical section of the door non-rebated door leaf

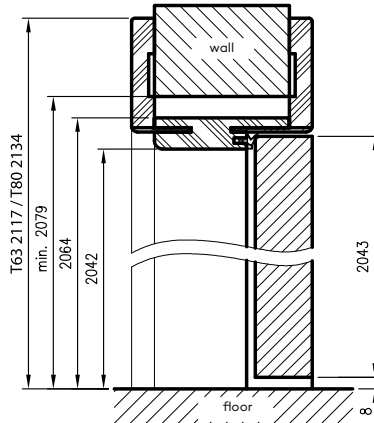

required wall passage height 2079 mm

ORB connection at 45

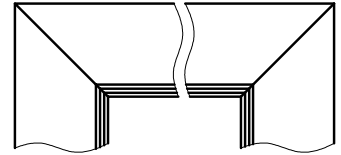

Adjustable non-rebated door frame connection at an angle of 90°** T80 architrave

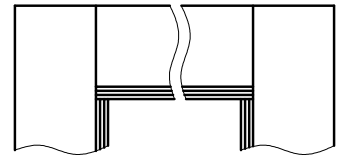

** 90° connection available in white matt, light grey matt, cashmere matt, warm grey matt, dark olive matt, dark blue matt, sage oak (structure), black matt 2, white acrylic UV painted, white pine, sand oak, 3D Polish oak, white varnish, black varnish and decors from the LUX and WOOD collections

D - required width of wall opening

E1 - dimension for T63 architrave

E2 - dimension for T80 architrave

*075-095 door frame has a different cross section, for 75-89 mm wall thickness, it is necessary to shorten the tongue of the adjustable architrave.

for double-leaf doors

	A	C	D	E1	E2
120	1274	1318	1350	1424	1458
130	1374	1418	1450	1524	1558
140	1474	1518	1550	1624	1658
150	1574	1618	1650	1724	1758
160	1674	1718	1750	1824	1858
170	1774	1818	1850	1924	1958
180	1874	1918	1950	2024	2058

for single-leaf doors

	A	C	D	E1	E2
"60"	627	671	700	777	811
"60N"	607	651	680	757	791
"70"	727	771	800	877	911
"70N"	707	751	780	857	891
"80"	827	871	900	977	1011
"80N"	807	851	880	957	991
"90"	927	971	1000	1077	1111
"90N"	907	951	980	1057	1091
"100"	1027	1071	1100	1177	1211
"100N"	1007	1051	1080	1157	1191

"xN" - width standard for selected single-leaf non-rebated panel construction door leaves

Black ST decor and laminates: standard gloss, metallic gloss, standard matt, xtreme matt only available with T80 architrave

ADJUSTABLE DOOR FRAMES

WITH VARIABLE HEIGHTS WITH ARCHITRAVE T80 OR T63

APPLICATION

The adjustable door frame with variable heights can be used for Standard 10, Modern, Plus rebated door leaves in three additional height options: 1983 mm, 2110 mm and 2240 mm.

SET CONTAINS

Main beam (one horizontal and two vertical elements together with masking elements), door seal, set of hinges, all necessary components for the installation of door frames in accordance with the supplied instruction. Door frames are packed in cardboard boxes. Door frames are packed in cardboard boxes.

All rebated door frames in 3 additional height options should be equipped with 3 hinges.



OR vertical cross-section

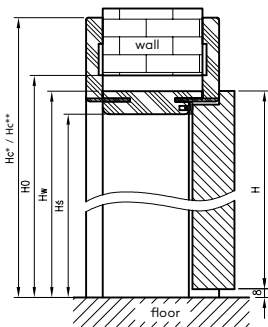

OR horizontal cross-section

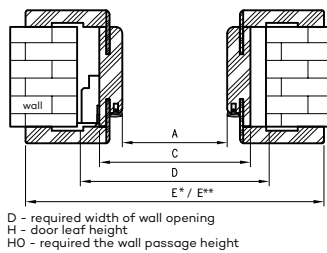

H	H _S	h _w	H ₀	h _c **	h _c *
1983	1969	1991	2006	2061	2044
2110	2096	2118	2133	2188	2171
2240	2226	2248	2263	2318	2301

H_c* - door leaf height with T63 architrave
H_c** - door leaf height with T80 architrave

OR (rebated door frame) cross-section with T80 architrave

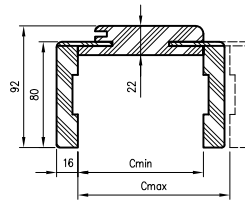

for single-leaf doors

	A	C	D	E**	E*
60	602	646	680	786	752
70	702	746	780	886	852
80	802	846	880	986	952
90	902	946	980	1086	1052
100	1002	1046	1080	1186	1152

for double-leaf doors

	A	C	D	E**	E*
120	1235	1279	1315	1419	1385
130	1335	1379	1415	1519	1485
140	1435	1479	1515	1619	1585
150	1535	1579	1615	1719	1685
160	1635	1679	1715	1819	1785
170	1735	1779	1815	1919	1885
180	1835	1879	1915	2019	1985
190	1935	1979	2015	2119	2085
200	2035	2079	2115	2219	2185

Extra charge for reinforcement for self closer applies to door frames with 45 degrees connection angle
Price of adjustable door frame for double leaf door: +30%.
Black ST decor available only with T80 architrave

ADJUSTABLE DOOR FRAMES

NON-REBATED WITH VARIABLE HEIGHTS WITH ARCHITRAVE T80 OR T63



APPLICATION

Non-rebated adjustable door frame with variable heights can be used with non-rebated STANDARD 10, MODERN and PLUS door leaf model which are available in three additional door leaf height options: 1983 mm, 2110 mm and 2240 mm.

SET CONTAINS

Main beam (one horizontal and two vertical elements together with masking elements), door seal, set of hinges, all necessary components for the installation of door frames in accordance with the supplied instruction. Door frames are packed in cardboard boxes. Door frames are packed in cardboard boxes.

All door frames in 3 additional height options can be equipped with 2 or 3 hinges.

ORB cross-section 095-300

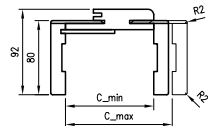

ORB cross-section 075

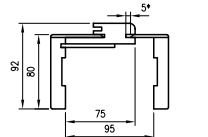

ORB vertical cross-section

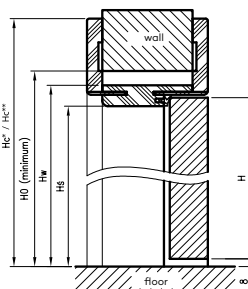

ORB horizontal cross-section

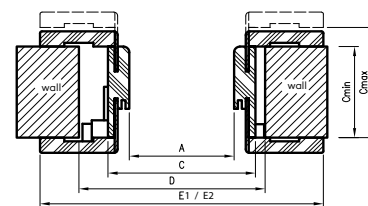

D - required width of wall passage

for single-leaf doors

	A	C	D	E1	E2
"60"	627	671	700	777	811
"70"	727	771	800	877	911
"80"	827	871	900	977	1011
"90"	927	971	1000	1077	1111
"100"	1027	1071	1100	1177	1211

E1 - dimension for T63 architrave
E2 - dimension for T80 architrave

H	H _S	hw	H ₀	hc **	hc *
1983	1982	2004	2019	2074	2057
2110	2109	2131	2146	2201	2184
2240	2239	2261	2276	2331	2314

H₀ - required the wall passage height

for double-leaf doors

	A	C	D	E2	E1
120	1274	1318	1350	1458	1424
130	1374	1418	1450	1558	1524
140	1474	1518	1550	1658	1624
150	1574	1618	1650	1758	1724
160	1674	1718	1750	1858	1824
170	1774	1818	1850	1958	1924
180	1874	1918	1950	2058	2024

* **NOTE:** 075-095 door frame has a different cross-section for wall thicknesses of 75-89 mm it will be necessary to shorten the tongue of the movable architrave by yourself.

Black ST decor and laminates: standard gloss, metallic gloss, standard matt, xtreme matt are only available with the T80 architrave.

Prices for door leaf heights 1983 and 2043 on pages 148-149

Prices include 2 hinges with assembly plates.

- Price of a door frame for double doors: +50% (extra charge when using 3 hinges)
- Extra charge for the third Estetic 80 hinge
- Extra charge for reinforcement for self closer applies to door frames with 45 degrees connection angle
- Extra charge for 90 degree connection (standard gloss, metallic gloss, standard matt, xtreme matt)

ADJUSTABLE DOOR FRAMES

FOR DOORS WITH INVERTED REBATE

CONSTRUCTION

Adjustable door frame with inverted rebate is made of high-quality wood-based board. On the exposure side it is covered with ecological, wood-like decorative foil DRE Cell, CPL black ST or painted with the highest quality UV acrylic varnishes. To ensure high quality of painted door frames, before varnishing they are covered with a special material constituting a uniform base. Its design is adapted to a door leaf thickness of 40 mm and allows for use in walls with a thickness of 90 - 290 mm. Connection at an angle of 45°.

APPLICATION

The door frame with an inverted rebate is applicable to selected collections: Estra, Nestor, Nova Cell, Uni, Binito, Fargo.

SET CONTAINS

Main beam (horizontal and two vertical elements), architrave T80 (horizontal and two vertical elements), door seal, set of two Estetic 1821 hinges, magnetic lock latch, door frame assembling set with the manual. Door frames are packed in cardboard packaging.



vertical cross-section of ORO

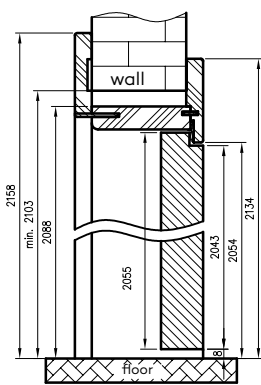

left door leaf

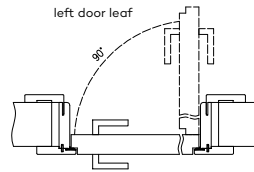

right door leaf

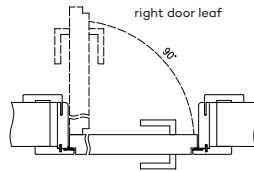

door frame profile

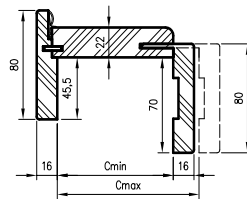

	A	C	D	E	F	S
60	625	694	724	785	834	644
70	725	794	824	885	934	744
80	825	894	924	985	1034	844
90	925	994	1024	1085	1134	944
100	1025	1094	1124	1185	1234	1044

horizontal cross-section of ORO

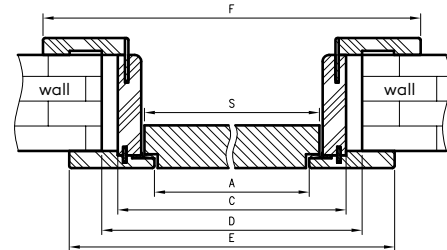

Required height of the wall opening = 2103 mm
D - required width of wall opening

Extra charge for the third Estetic 1821 hinge

DECORS

PAINTED	white	NEW cashmere	NEW sabio
	ashen	latte	
DRE CELL	White matt	light gray matt	warm gray matt
	cashmere matt	sage oak (textured)	dark olive matt
NEW	sage matt	blackmat.2	CPL Laminate
			black ST

white - UV acrylic varnish - RAL 9003
cashmere - NCS S1502-Y50R
sabio - NCS S3005-G80Y
latte - Flugger 4362, NCS S1505-Y50R
ashen - RAL 7035

ADJUSTABLE TUNNEL

WITH ARCHITRAVE T80 or T63

APPLICATION

Adjustable tunnel is a decorative cover of wall passage. It can be used as a separate solution or as an integral part of the sliding wall-mounted system NT.

The adjustable tunnel is a product which is, at first glance visually similar to adjustable door frames, but with a few differences:

- there is no possibility to mount any hinges
- there is no latch strike plate
- no milling for the seal, different height and span of the front and rear architraves (E and F values in the tables)

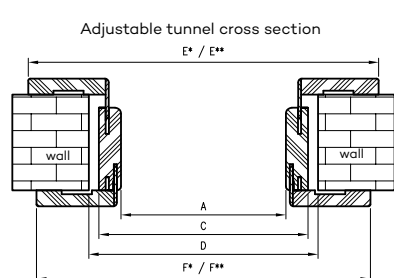

D - required width of wall opening
*refers to Adjustable Tunnel with T63
*refers to Adjustable Tunnel with T80

TUN cross-section with T80 architrave

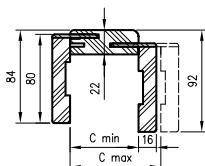

tunnel cross-section with T63 architrave

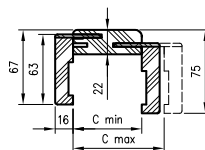

Vertical cross-section of adjustable tunnel with T80 architrave

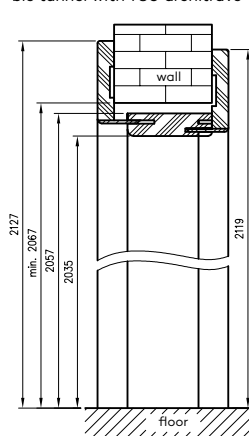

Vertical section of the adjustable tunnel with T63 architrave

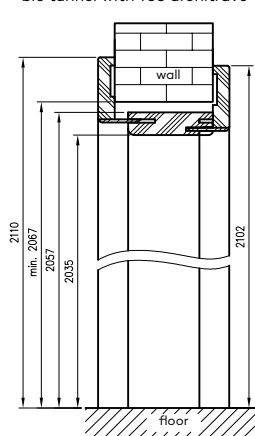

Required height of the wall opening 2067 mm.

NOTE: To ensure the highest quality of painted tunnels, before painting process they are coated with special material which constitutes solid base.

SINGLE ADJUSTABLE TUNNEL

symbol	60	70	80	90	100
A	602	702	802	902	1002
C	646	746	846	946	1046
D	664	764	864	964	1064
E*	752	852	952	1052	1152
E**	786	886	986	1086	1186
F*	736	836	936	1036	1136
F**	770	870	970	1070	1170

DOUBLE ADJUSTABLE TUNNEL

symbol	120	130	140	150	160	170	180	190	200	symbol	120	130	140	150	160	170	180	190	200
A	1200	1300	1400	1500	1600	1700	1800	1900	2000	E**	1384	1484	1584	1684	1784	1884	1984	2084	2184
C	1244	1344	1444	1544	1644	1744	1844	1944	2044	F*	1334	1434	1534	1634	1734	1834	1934	2034	2134
D	1264	1364	1464	1564	1664	1764	1864	1964	2064	F**	1368	1468	1568	1668	1768	1868	1968	2068	2168
E*	1350	1450	1550	1650	1750	1850	1950	2050	2150										

OPTIONS AVAILABLE WITH EXTRA CHARGE

Tunnel for double leaf door: +30%

2nd group CPL - CPL laminate natural halifax oak.
Black ST decor only available with T80 architrave.

ADJUSTABLE DOOR FRAMES

WITH ANGLE PANELS



FARGO 30 - white

DECORS

PAINTED	white	NEW	NEW	latte	ashen
		cashmere	sabio		

white - UV acrylic varnish - RAL 9003
cashmere - NCS S1502-Y50R
sabio - NCS S3005-G80Y
latte - Flugger 4362, NCS S1505-Y50R
ashen - RAL 7035

$$\text{Price of the set} = \text{price of two vertical beams} + \text{price of the horizontal beam with architrave panels}$$

ADJUSTABLE DOOR FRAMES

WITH ANGLE PANELS



CONSTRUCTION

Adjustable non-rebated door frame is made of a high-quality wood-based MDF board. On its visual side it is entirely coated with a foil and in next step is painted. Its construction allows to be used with door leaf with the thickness of 40 mm and its design allows to be used on walls with span 75-320. On horizontal beam there are made special architrave panels in three optional dimensions: 80 mm, 180 mm or 900 mm.

APPLICATION

Adjustable non-rebated door frame with architrave panels can be used with all DRE non-rebated painted collections.

SET CONTAINS

Main beam with wide architrave (80 mm) with small rounding angles of the cross-section profile (R2), horizontal beam with architrave panels in 3 optional dimensions, door gasket, a set of hinges, all necessary components for the installation of door frames in accordance with the supplied instruction. Door frames are packed in cardboard boxes.

horizontal cross-section of the lintel

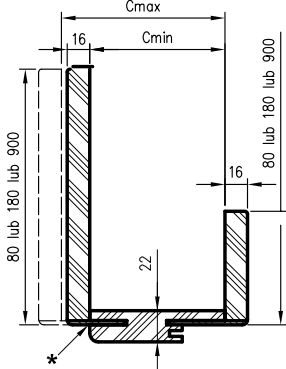

cross-section of vertical beam

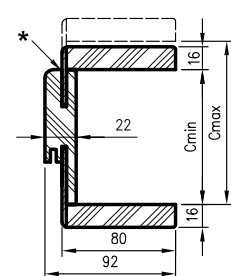

side B A-A Vertical section side A

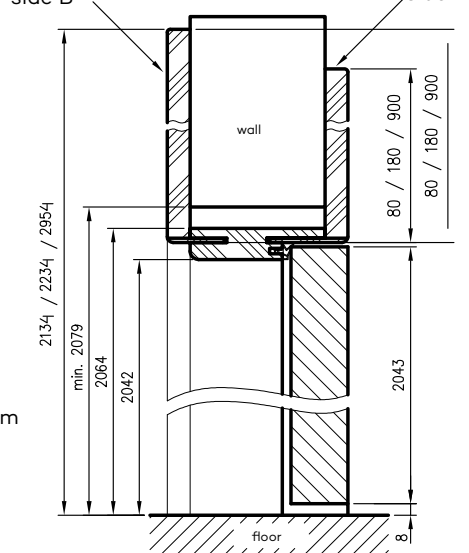

Required height of the wall opening = 2079 mm

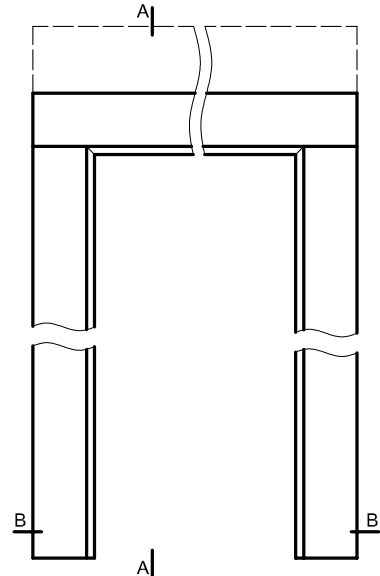

B-B Horizontal cross-section

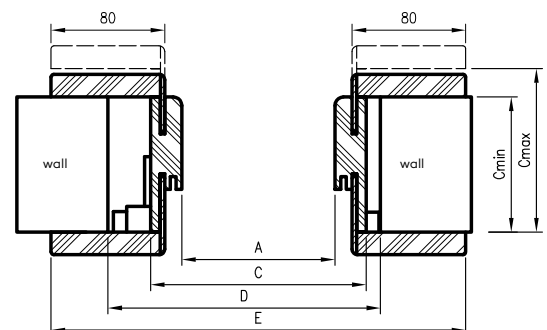

D - required width of wall opening

*NOTE: 075-095 door frame has a different cross-section, shallow milling for architrave, for a 75-89 mm wall thickness, it will be necessary to shorten the tongue of the adjustable masking architrave.
** - third hinge, option at extra charge

for single-leaf doors

	A	C	D	E
"60"	627	671	700	811
"60N"	607	651	680	791
"70"	727	771	800	911
"70N"	707	751	780	891
"80"	827	871	900	1011
"80N"	807	851	880	991
"90"	927	971	1000	1111
"90N"	907	951	980	1091
"100"	1027	1071	1100	1211
"100N"	1007	1051	1080	1191

"xN" - width standard for selected single-leaf non-rebated panel construction door leaves

EXTENSION PANELS

APPLICATION

The extension panel is a component of the decorative construction of a passage in a wall or the enlargement of possibility of installing door frames with thick walls over 320 mm. The panel is an extension of the central parts of adjustable door frames and adjustable tunnels. It is used when using adjustable architraves, from previously ordered door frames or tunnels with a connection angle of 45°.

Connection angle of 90° for OR (adjustable door frame) panels comes in color white matt, light grey matt, cashmere matt, warm grey matt, dark olive matt, dark blue matt, sage oak, black matt 2, white acrylic UV varnish, white pine, vintage oak, sand oak, Polish oak 3D

Connection angle of 90° for ORB (adjustable non-rebated door frame) panels, comes in color white matt, light grey matt, cashmere matt, warm grey matt, dark olive matt, dark blue matt, sage oak, black matt 2, white acrylic UV varnish, white pine, sand oak, vintage oak, Polish oak 3D, acrylic laminates (standard gloss, metallic gloss, standard matt, xtreme matt)

Extension panels with variable heights are available in Cell and CPL veneer groups and laminates: metallic gloss, standard matt, standard gloss, xtreme matt.

SET CONTAINS

- two vertical beams
- horizontal beam
- three connecting tongues
- accessories used to connect main beams

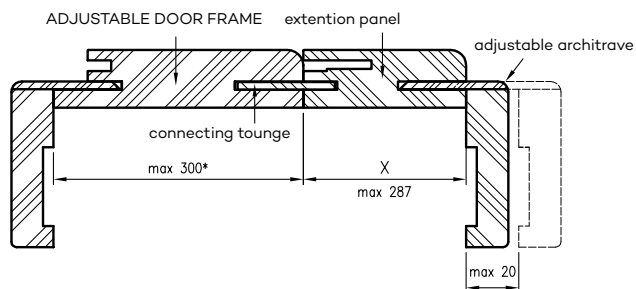
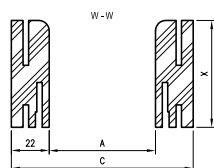
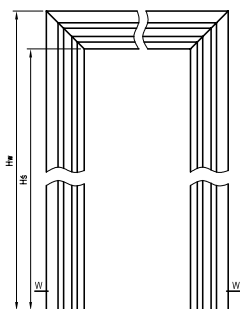

* in ORS max 280
in ORO max 270
in TUN max 287

options of the width of panels cross-section

X	062	082	107	127	147	167	187	207	227	247	267	287
---	-----	-----	-----	-----	-----	-----	-----	-----	-----	-----	-----	-----

EXTENSION PANELS

Dimensions of extension panels OR - adjustable door frames for rebated doors

height options					for single-leaf doors							for double-leaf doors										
	PL	198x	211x	224X	"60"	"70"	"80"	"90"	"100"	"110"	"100d"	"110d"	"120"	"130"	"140"	"150"	"160"	"170"	"180"	"190"	"200"	
HŚ	2029	1969	2096	2226	A	602	702	802	902	1002	1102	1035	1135	1235	1335	1435	1535	1635	1735	1835	1935	2035
hw	2051	1991	2118	2248	C	646	746	846	946	1046	1146	1079	1179	1279	1379	1479	1579	1679	1779	1879	1979	2079

Dimensions of the ORB extension panels connected at 45° - non-rebated adjustable door frames for non-rebated doors connected at 45°

height options					for single-leaf doors										for double-leaf doors							
	PL	198x	211x	224X	"60"	"60N"	"70"	"70N"	"80"	"80N"	"90"	"90N"	"100"	"100N"	"120"	"130"	"140"	"150"	"160"	"170"	"180"	
HŚ	2042	1982	2109	2239	A	627	607	727	707	827	807	927	907	1027	1007	1274	1374	1474	1574	1674	1774	1874
hw	2064	2004	2131	2261	C	671	651	771	751	871	851	971	951	1071	1051	1318	1418	1518	1618	1718	1818	1918

Dimensions of TUN extension panels - adjustable tunnels

		for single-leaf doors						for double-leaf doors								
	PL	"60"	"70"	"80"	"90"	"100"	"120"	"130"	"140"	"150"	"160"	"170"	"180"	"190"	"200"	
HŚ	2035	A	602	702	802	902	1002	1200	1300	1400	1500	1600	1700	1800	1900	2000
hw	2057	C	646	746	846	946	1046	1244	1344	1444	1544	1644	1744	1844	1944	2044

"xN" - width standard for selected single-leaf non-rebated panel construction door leaves

Dimensions of the ORC extension panels - adjustable door frames for glass doors

	PL	"60"	"70"	"80"	"90"	
HŚ	2035	A	600	700	800	900
hw	2057	C	644	744	844	944

Dimensions of the ORS extension panels - adjustable door frames for folding doors

	PL	"80"	"90"	"100"	
HŚ	2029	A	806	906	1006
hw	2051	C	850	950	1050

Dimensions of ORO extension panels - adjustable door frames for door leaves with inverted rebate

	PL	"60"	"70"	"80"	"90"	"100"	
HŚ	2066	A	650	750	850	950	1050
hw	2088	C	694	794	894	994	1094

OPTIONS AVAILABLE WITH EXTRA CHARGE

- Double door panel: +30%
- Extra charge for connecting at an angle of 90°

STEEL FIXED DOOR FRAMES

DOOR FRAME CONSTRUCTION

Steel door frames are made of 1.5 mm thick low-carbon steel sheet, protected with a varnished, organic protective coating. The door frame consists of two stands: a catch and a hinge (in the door frame for double-leaf doors, both hinge stands) and a lintel, permanently connected to each other by welding. The hinge stands are equipped with hinge sockets, while the catch stands have cutouts for the tongue and bolts of the lock dedicated to the door leaf (the set includes a closing gasket).

The profile of the door frame, its dimensions, equipment and colors depend on the selected variant - the type of door for which the door frame is to be used.

APPLICATION / TYPES OF OSS DOOR FRAMES (FIXED STEEL DOOR FRAMES)

OSS_STAND	OSS For rebated interior doors
OSSB_STAND	OSS for non-rebated interior doors
OSS_GLASS	OSS for interior glass doors
OSS_ENTER	OSS for the Enter door, Enter Akustik, Revos
OSS_SOLID	OSS for solid doors
OSS_SOLID_RC2	OSS for Solid RC2 door leaf
OSS_ATHOS	OSS for Athos door leaf
OSS_FORCA	OSS (steel fixed door frame) for Forca or Forca B doors
OSS_OLIMP_EI30	OSS for Olimp EI-30 door leaf



All frames are designed to be mounted on the finished floor.

STANDARD OPTIONS IN OSS

- sockets for 2, 3, 4 or 6 hinges
- socket for latch plate of main lock

STANDARD OPTIONS IN OSSB

- sockets for 2, 4 or 6 hinges
- magnetic lock latch

STANDARD OPTIONS IN OSS GLASS

- sockets for 2 hinges
- socket for latch plate of main lock

STANDARD OPTIONS IN OSS ENTER

- sockets for 3 hinges
- socket for main lock or additionally for upper lock

STANDARD OPTIONS IN OSS SOLID

- sockets for 3 hinges
- additional sockets for anti-thrust bolts
- sockets for latch bolts of multi-point lock used in SOLID model

STANDARD OPTIONS IN OSR SOLID RC2

- sockets for 3 triple hinges
- additional sockets for anti-thrust bolts
- sockets for latch bolts of multi-point lock used in SOLID model

STANDARD OPTIONS IN OSS ATHOS, FORCA, FORCA B

- sockets for 3 triple hinges
- additional sockets for anti-thrust bolts
- sockets for latch plates of five point mortise lock (FORCA, FORCA B)
- socket for latch plate of main lock (ATHOS)

STANDARD OPTIONS FOR OSS OLIMP EI30

- sockets for 3 three-part hinges
- socket for latch plate of main lock

AVAILABLE COLOURS

Door frame is powder coated in two gloss scale (matt / low structure or semi-gloss / plain). There are available colours:



*** beige colour is available only in semi-gloss

STEEL FIXED DOOR FRAMES

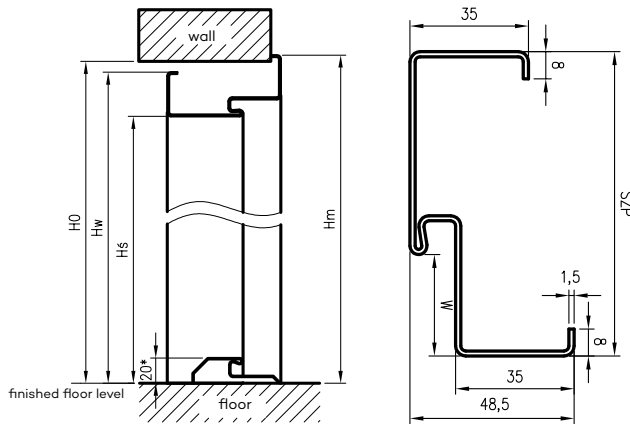

type of the door frame	HO	H _S	hw	hm	W	SZP
OSSB STAND	2084	2040,5	2075,5	2089	48	106
OSS STAND	2071	2027,5*	2062,5	2076	30	90
steel fixed door frame for ENTER						
OSS SOLID						
OSS SOLID RC2						
STEEL FIXED DOOR FRAME FOR GLASS DOORS	2077	2033,5	2068,5	2082	30	90
OSS ATHOS	2073	2029,5*	2064,5	2078	38	117
OSS FORCA						
OSS OLIMP EI30	2070	2025,5	2060,5	2074		

H₀ - height of the wall opening
H_S - height of the door frame passage
* - with the use of a steel threshold - the actual height of the door frame passage will be reduced by 20mm from the floor

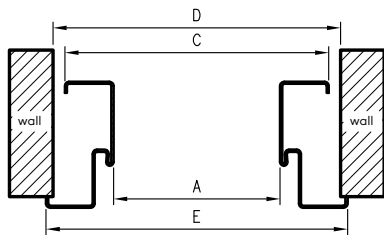

D - width of the assembly hole

OSS OLIMP EI30
for single leaf door

symbol width.	A	C	D	E
"80"	802	872	889	899
"90"	902	972	989	999
"90E"	917	987	1004	1014
"100"	1002	1072	1089	1099
"110"	1102	1172	1189	1199

"xN" - width standard for selected single-leaf non-rebated panel construction door leaves

OSSB STAND
for single leaf door

symbol width.	A	C	D	E
"60"	624	694	711	721
"60N"	604	674	691	701
"70"	724	794	811	821
"70N"	704	774	791	801
"80"	824	894	911	921
"80N"	804	874	891	901
"90"	924	994	1011	1021
"90N"	904	974	991	1001
"100"	1024	1094	1111	1121
"100N"	1004	1074	1091	1101

OSS width dimensions

symbol width.	A	C	D	E	OSS STAND	OSS glass doors	OSS ENTER	OSS SOLID	OSS SOLID RC2	OSS ATHOS	OSS FORCA
"60"	600	670	687	697	•	•					
"70"	700	770	787	797	•	•	•				
"80"	800	870	887	897	•	•	•	•	•	•	•
"90"	900	970	987	997	•	•	•	•	•	•	•
"90E"	904	974	991	1001	•		•	•	•		
"90E"	915	985	1002	1012						•	•
"100"	1000	1070	1087	1097	•	•	•	•	•	•	•
"110"	1100	1170	1187	1197	•	•	•	•	•	•	•

**** - investment dimension "90E" different for technical and other doors

OSS STAND dimensions
for double leaf doors

symbol width.	A	C	D	E
"100b"	1034	1104	1121	1131
"110b"	1134	1204	1221	1231
"120"	1234	1304	1321	1331
"130"	1334	1404	1421	1431
"140"	1434	1504	1521	1531
"150"	1534	1604	1621	1631
"160"	1634	1704	1721	1731
"170"	1734	1804	1821	1831
"180"	1834	1904	1921	1931
"190"	1934	2004	2021	2031
"200"	2034	2104	2121	2131

OSSB STAND
for double leaf doors

symbol width.	A	C	D	E
"120"	1271	1341	1358	1368
"130"	1371	1441	1458	1468
"140"	1471	1541	1558	1568
"150"	1571	1641	1658	1668
"160"	1671	1741	1758	1768
"170"	1771	1841	1858	1868
"180"	1871	1941	1958	1968

* - STAND steel fixed door frames for double leaf door "100d" - "200" width

** - OSS FORCA B - OSS FORCA option for Forca B doors (without fire resistance)

*** - steel fixed non-rebated OSSB STAND single-leaf door frames with 3 hinges, extra charge

for double-leaf doors with 6 hinges, extra charge of

STEEL ADJUSTABLE REBATED

The essence of the adjustable door frame is that its construction allows to instal door frame, without additional finishing work. Angular architrave allows for additional adjustment in the range + 30mm.

APPLICATION / TYPES OF OSR DOOR FRAMES ((STEEL ADJUSTABLE DOOR FRAMES))

OSR_STAND	OSR For rebated interior doors	
OSRB_STAND	OSR for non-rebated interior doors	
OSR_GLASS	OSR For interior glass doors	
OSR_ENTER	OSR for the door leaf Enter, Enter Akustik, Revos	
OSR_SOLID	OSS for solid doors	
OSR_SOLID_RC2	OSR for Solid RC2	
OSR_ATHOS	OSR for Athos door leaf	
OSR_FORCA	OSR for Forca or Forca B door leaf	
steel adjustable door frame	OSR_OLIMP EI 30	OSS for Olimp EI-30 door leaf
steel adjustable door frame	OSR_OLIMP EI 60	steel adjustable door frame OSR for Olimp EI 60 doors



All frames are designed to be mounted on the finished floor.

The door frames are suitable for walls with a thickness of 95-305 mm, 103-313 mm in the case of adjustable steel door frame OSR FORCA, adjustable steel door frame OSR ATHOS and adjustable steel door frame OSR OLIMP EI30 or 113-323 mm in the case of adjustable steel door frame OSR OLIMP EI 60. For a given wall thickness, select the appropriate door frame variant, the range of which Cmin - Cmax will contain the thickness of the finished wall

CONSTRUCTION

Steel door frames are made of 1.5 mm thick low-carbon steel sheet, powder coated. The door frame consists of two stands: a catch and a hinge (in the door frame for double-leaf doors, both hinge stands) and a lintel, permanently connected to each other by welding. The hinge stands are equipped with hinge sockets, while the catch stands have cutouts for the tongue and bolts of the lock dedicated to the door leaf (the set includes a closing gasket). The outer and inner side of the door frame is protected with a varnished, organic protective coating. The profile of the door frame, its dimensions and equipment depend on the selected variant - the type of door to which the door frame is to be applied

STANDARD OPTIONS IN OSR STAND

- sockets for 2, 3, 4 or 6 hinges
- socket for latch plate of main lock

STANDARD OPTIONS IN OSRB STAND

- sockets for 2, 4 or 6 hinges
- magnetic lock latch

STANDARD OPTIONS IN OSR GLASS DOORS

- sockets for 2 hinges
- socket for latch plate of main lock

STANDARD OPTIONS IN OSR ENTER

- sockets for 3 hinges
- socket for main lock or additionally for upper lock

STANDARD OPTIONS IN OSR SOLID

- sockets for 3 hinges
- additional sockets for anti-thrust bolts
- sockets for latch bolts of multi-point lock used in SOLID model

STANDARD OPTIONS IN OSR SOLID RC2

- sockets for 3 triple hinges
- additional sockets for anti-thrust bolts
- sockets for latch bolts of multi-point lock used in SOLID model

STANDARD OPTIONS IN OSR ATHOS, FORCA, FORCA B

- sockets for 3 triple hinges
- additional sockets for anti-thrust bolts
- sockets for latch plates of five point mortise lock (FORCA, FORCA B)
- socket for latch plate of main lock (ATHOS)

STANDARD OPTIONS FOR OSR OLIMP EI30

- sockets for 3 threefold hinges
- socket for latch plate of main lock

STANDARD OSR OLIMP EI 60

- sockets for 3 pcs. of three-part or object hinges
- socket for latch plate of main lock

AVAILABLE COLOURS

Door frame is powder coated in two gloss scale (matt / low structure or semi-gloss / plain). There are available colours:



*** beige colour is available only in semi-gloss

STEEL ADJUSTABLE REBATED

DOOR FRAMES

ADJUSTABLE STEEL REBATED DOOR FRAMES - DIMENSIONS

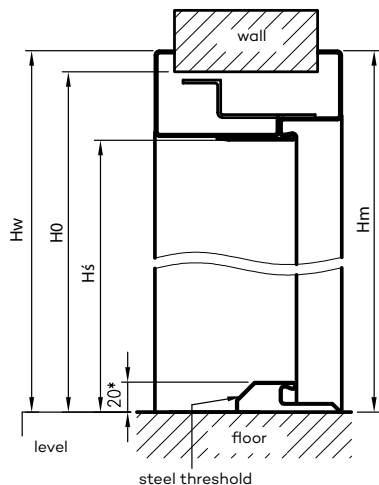

OSR door frame profile with the T57 architrave

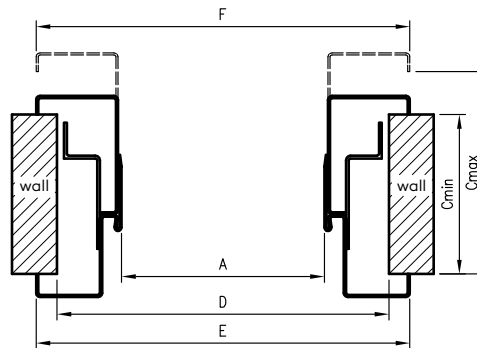

* - with the use of a steel threshold - the actual height of the door frame passage will be reduced by 20mm from the floor
D - width of the wall opening

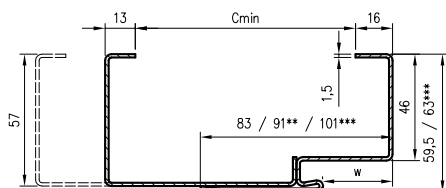

** 91 for OSR ATHOS, OSR FORCA, OSR FORCA B and OSR OLIMP EI 30
*** applies to OSR Olimp EI 60

OSR OLIMP EI30 for single leaf door

symbol width.	A	D	E	F
"80"	802	892	921	921
"90"	902	992	1021	1021
"90E"	917	1007	1036	1036
"100"	1002	1092	1121	1121
"110"	1102	1192	1221	1221

OSR OLIMP EI60 for single leaf door

symbol width.	A	D	E	F
"80"	797	894	923	916
"90"	897	994	1023	1016
"90E"	926	1023	1052	1045
"100"	997	1094	1123	1116
"110"	1097	1194	1223	1216

OSR width dimensions

symbol width.	A	D	E	OSR_STAND	OSR_GLASS DOORS	OSR_ENTER	OSR_SOLID	OSR_SOLID_RC2	OSR_ATHOS	OSR_FORCA
"60"	600	690	719	•	•					
"70"	700	790	819	•	•	•				
"80"	800	890	919	•	•	•	•	•	•	•
"90"	900	990	1019	•	•	•	•	•	•	•
"90E"	904	994	1023	•		•	•			
"90E"	915	1005	1034						•	•
"100"	1000	1090	1119	•		•	•	•	•	•
"110"	1100	1190	1219	•		•	•	•	•	•

**** - investment dimension "90E" different for technical and other doors

OSR STAND dimensions for double leaf doors

symbol width.	A	D	E	F
"100D"	1034	1124	1153	1153
"110D"	1134	1224	1253	1253
"120"	1234	1324	1353	1353
"130"	1334	1424	1453	1453
"140"	1434	1524	1553	1553
"150"	1534	1624	1653	1653
"160"	1634	1724	1753	1753
"170"	1734	1824	1853	1853
"180"	1834	1924	1953	1953
"190"	1934	2024	2053	2053
"200"	2034	2124	2153	2153

type of the door frame	HO	Hs	hw	hm	W
OSR_STAND					
OSR_ENTER	2073	2027,5*	2088	2087	30
OSR_SOLID					
OSR_SOLID_RC2					
OSR_GLASS DOORS	2079	2033,5	2094	2093	30
OSR_ATHOS	2073	2027,5*	2088	2087	38
OSR_FORCA					
OSR OLIMP EI30	2073	2027,5	2088	2087	
OSR OLIMP EI60	2072	2023	2083,5	2086	48

HO - height of the wall opening

Hs - height of the door frame passage

* - with the use of a steel threshold - the actual height of the door frame passage will be reduced by 20mm from the floor

STEEL ADJUSTABLE REBATED

DOOR FRAMES



STEEL ADJUSTABLE NON-REBATED

DOOR FRAMES

STEEL ADJUSTABLE NON-REBATED DOOR FRAMES - DIMENSIONS

OSRB horizontal cross-section

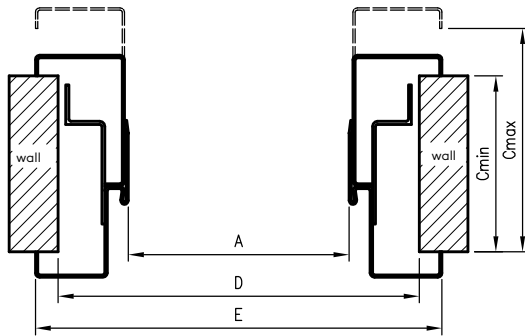

D - width of the assembly hole

Vertical section of the OSRB

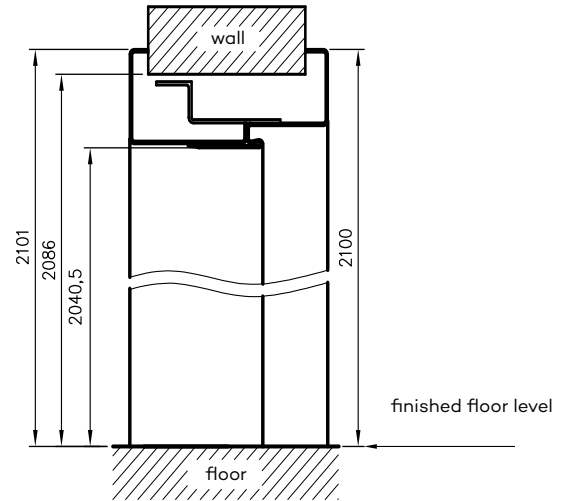

OSRB door frame profile

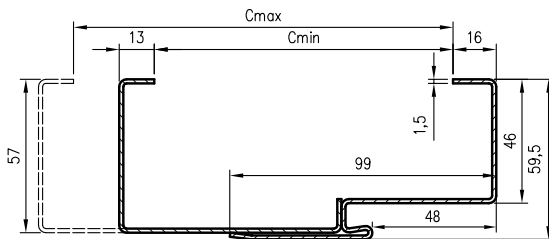

Dimensions for double leaf doors

symbol width.	A	D	E
„120”	1271	1361	1390
„130”	1371	1461	1490
„140”	1471	1561	1590
„150”	1571	1661	1690
„160”	1671	1761	1790
„170”	1771	1861	1890
„180”	1871	1961	1990

Dimensions for single leaf doors

symbol width.	A	D	E
"60"	624	714	743
"60N"	604	694	723
"70"	724	814	843
"70N"	704	794	823
"80"	824	914	943
"80N"	804	894	923
"90"	924	1014	1043
"90N"	904	994	1023
"100"	1024	1114	1143
"100N"	1004	1094	1123

"xN" - width standard for selected single-leaf non-rebated panel construction door leaves

Note: Extra charge for reinforcement for the self closer

STEEL HYBRID DOOR FRAMES

CONSTRUCTION:

Steel hybrid door frames are a solution combining the solidity of a metal structure with additional functionality allowing for full construction of the door frame using wood-based door frame elements finished with CPL laminate. The hybrid door frame is a combination of a fixed-width steel door frame, a wood-based panel available in 11 width variants and a masking architrave. This solution allows for the installation of a door frame with a thickness of 137-337 mm (145-345 for technical doors and 155-355 for Olimp EI60 doors) and adjustment with an architrave up to 20 mm. Door frame profile dimensions and equipment depend on selected option - door leaf model.

APPLICATION / TYPES OF OSH DOOR FRAMES (STEEL HYBRID DOOR FRAMES)

OSH_STAND	OSH for rebated interior door leaf	
OSHB_STAND	OSH for non-rebated interior doors	
OSH_GLASS	OSH For interior glass doors	
OSH_ENTER	OSH for the door Enter, Akustik, Revos	
OSH_SOLID	OSH for Solid doors	
OSH_SOLID_RC2	OSH for Solid RC2	
OSH_ATHOS	OSH for the Athos door leaf	
OSH_FORCA	OSH for Forca or Forca B door leaf	
steel hybrid door frame OSH_OLIMP EI 30		OSH for Olimp EI-30 door leaf
steel hybrid door frame OSH_OLIMP EI 60		steel hybrid door frame OSH for
Olimp EI 60 doors		



All frames are designed to be mounted on the finished floor.

STANDARD OPTIONS IN OSH STAND

- sockets for 2 or 3 hinges
- socket for latch plate of main lock
- In the door frame for double leaf doors - sockets for 4 or 6 pcs. of hinges

STANDARD OPTIONS IN OSHB STAND

- sockets for 2 or 4 hinges
- magnetic lock latch

STANDARD OPTIONS IN OSH GLASS

- sockets for 2 hinges
- socket for latch plate of main lock

STANDARD OPTIONS IN OSH ENTER

- sockets for 3 hinges
- socket for main lock or additionally for upper lock

STANDARD OPTIONS IN OSH SOLID

- sockets for 3 hinges
- additional sockets for anti-thrust bolts
- sockets for latch bolts of multi-point lock used in SOLID model

STANDARD OPTIONS IN OSH SOLID RC2

- sockets for 3 triple hinges
- additional sockets for anti-thrust bolts
- sockets for latch bolts of multi-point lock used in SOLID model

STANDARD OPTIONS IN OSH ATHOS, FORCA

- sockets for 3 triple hinges
- additional sockets for anti-thrust bolts
- sockets for latch plates of five point mortise lock (FORCA, FORCA B)
- socket for latch plate of main lock (ATHOS)

STANDARD OPTIONS FOR OSH OLIMP EI30

- socket for latch plate of main lock
- sockets for 3 triple hinges

AS A STANDARD STEEL HYBRID DOOR FRAME OSH OLIMP EI60

- socket for latch plate of main lock
- sockets for 3 pcs. of three-part or object hinges

AVAILABLE COLOURS

Door frame is powder coated in two gloss scale (matt / low structure or semi-gloss / plain). There are available colours:

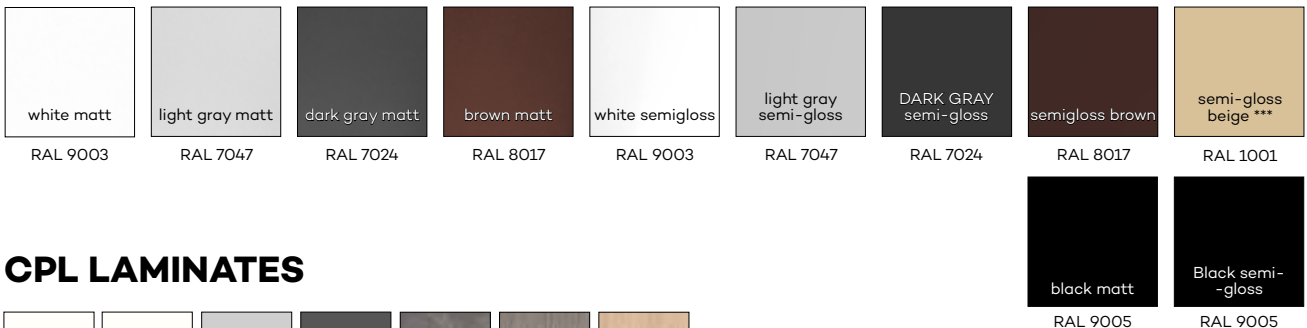

*** beige colour is available only in semi-gloss

CPL LAMINATES



STEEL HYBRID REBATED

DOOR FRAMES

STEEL HYBRID REBATED DOOR FRAMES - DIMENSIONS

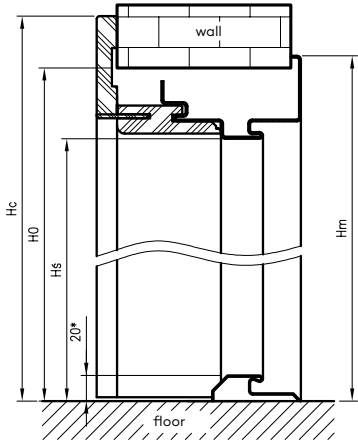

OSH STAND dimensions for double leaf doors

symbol width.	A	D	E	F
„100D”	1034	1144	1164	1226
„110D”	1134	1244	1264	1326
„120”	1234	1344	1364	1426
„130”	1334	1444	1464	1526
„140”	1434	1544	1564	1626
„150”	1534	1644	1664	1726
„160”	1634	1744	1764	1826
„170”	1734	1844	1864	1926
„180”	1834	1944	1964	2026
„190”	1934	2044	2064	2126
„200”	2034	2144	2164	2226

OSH (Steel Hybrid door frames) width dimensions

symbol width.	A	D	E	F	OSH_STAND	OSH glass doors	OSH ENTER	OSH SOLID	OSH SOLID RC2	OSH ATHOS	OSH FORCA
„60”	600	710	730	792	•	•					
„70”	700	810	830	892	•	•	•				
„80”	800	910	930	992	•	•	•	•	•	•	•
„90”	900	1010	1030	1092	•	•	•	•	•	•	•
„90E”	904	1014	1034	1096			•	•	•		
„90E”	915	1025	1045	1107						•	•
„100”	1000	1110	1130	1192	•		•	•	•	•	•
„110”	1100	1210	1230	1292	•		•			•	•

**** - investment dimension "90E" different for technical and other doors

D - width of the assembly hole
Select the appropriate option of the adjustable panel with masking architrave (Cmin) for a specific wall thickness

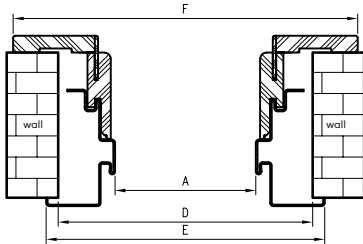

OSH OLIMP EI30 dimensions for single leaf door

symbol width.	A	D	E	F
„80”	802	912	932	994
„90”	902	1012	1032	1094
„90E”	917	1027	1047	1109
„100”	1002	1112	1132	1194
„110”	1102	1212	1232	1294

door frame profile

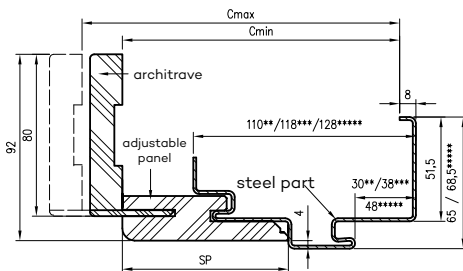

** - dimensions for remaining OSH frames
*** - dimensions for OSH ATHOS, OSH FORCA and OSH OLIMP EI 30
**** - dimensions for steel hybrid door frame OSH OLIMP EI 60

type of the door frame.	H0	Hs	hm	HC
OSH_STAND				
OSH ENTER	2083	2027,5*	2092,5	2124
OSH SOLID				
OSH SOLID RC2				
OSH glass doors	2089	2033,5	2098,5	2130
OSH ATHOS	2085	2029,5*	2094,5	2126
OSH FORCA				
OSH OLIMP EI30	2081	2025,5	2090	2122
OSH OLIMP EI60	2082	2023	2091,5	2119

H0 - height of the wall opening
Hs - height of the door frame passage
* - when using a steel threshold - actual the height of the clear passage will decrease by 20mm from the given one

Dimensions OSH OLIMP EI60 for single leaf door

symbol width.	A	D	E	F
„80”	797	907	934	989
„90”	897	1007	1034	1089
„90E”	926	1036	1063	1118
„100”	997	1107	1134	1189
„110”	1097	1207	1234	1289

Door Frame price = price of the metal part + price of an adjustable panel with a masking architrave

STEEL HYBRID NON-REBATED

NON-REBATED

STEEL HYBRID NON-REBATED DOOR FRAMES - DIMENSIONS

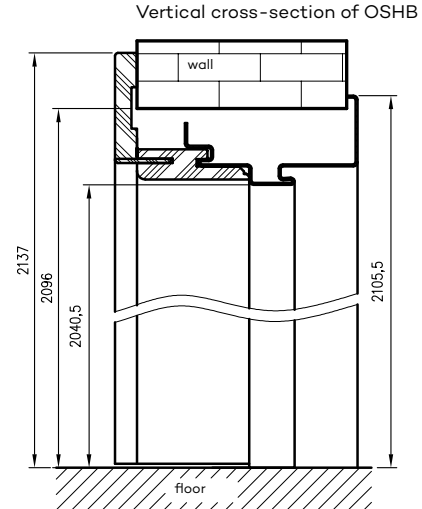
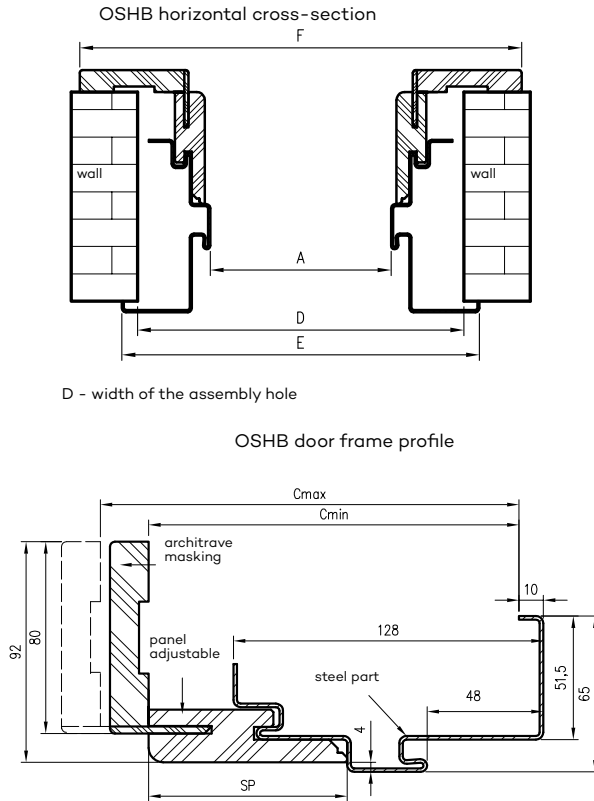

Select the appropriate option of the adjustable panel with masking architrave (Cmin) for a specific wall thickness

Dimensions for single leaf doors

symbol width.	A	D	E	F
"60"	624	734	754	816
"60N"	604	714	734	796
"70"	724	834	854	916
"70N"	704	814	834	896
"80"	824	934	954	1016
"80N"	804	914	934	996
"90"	924	1034	1054	1116
"90N"	904	1014	1034	1096
"100"	1024	1134	1154	1216
"100N"	1004	1114	1134	1196

"xN" - width standard for selected single-leaf non-rebated panel construction door leaves

Dimensions for double leaf doors

symbol width.	A	D	E	F
„120"	1271	1381	1401	1463
„130"	1371	1481	1501	1563
„140"	1471	1581	1601	1663
„150"	1571	1681	1701	1763
„160"	1671	1781	1801	1863
„170"	1771	1881	1901	1963
„180"	1871	1981	2001	2063

*** - steel hybrid non-rebated OSHB STAND single-leaf door frames with 3 hinges extra charge for double-leaf doors with 6 hinges, extra charge of

SMALL ANGULAR REBATED

DOOR FRAMES

CONSTRUCTION:

The steel door frames are made of 1.2 mm thick low-carbon steel sheet, protected with a varnish, organic protective coating. The door frame consists of two stands: latch strike plate and hinge, and a lintel, permanently connected by welding. Hinged racks are equipped with hinge sockets (2-3 pcs.), while hook racks have cutouts for the tongue and latches of the dedicated door leaf lock (the set includes a covering gasket).

APPLICATION

Small Angular Steel Door Frame - door frame designed for rebated interior doors



small angular steel door frame profile

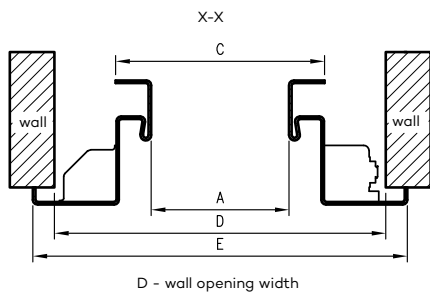
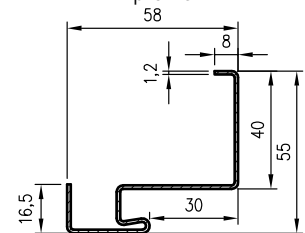
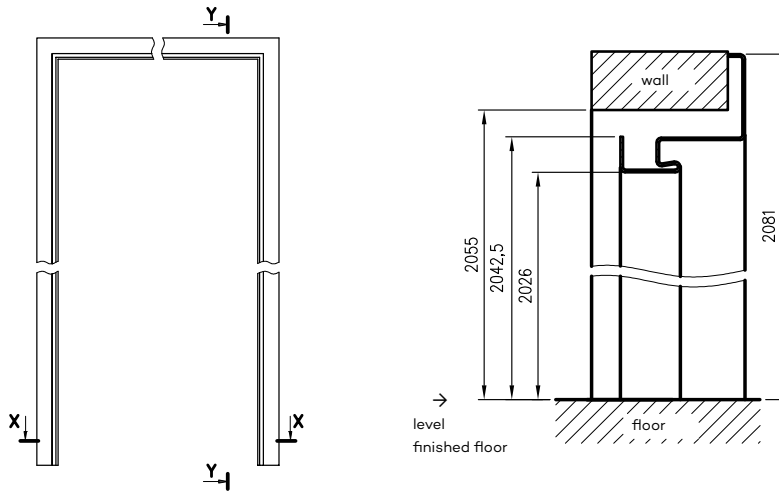

Dimensions for single leaf doors

symbol width.	A	C	D	E
"60"	600	633	690	710
"70"	700	733	790	810
"80"	800	833	890	910
"90"	900	933	990	1010
"90E"	904	937	994	1014
"100"	1000	1033	1090	1110

AVAILABLE COLOURS

Door frame is powder coated in two gloss scale (matt / low structure or semi-gloss / plain). There are available colours:



*** beige colour is available only in semi-gloss

Door handles



POLARIS door handle - chrome
inserts in DRE-Cell, 3D and CPL colors
inserts in acrylic laminates



POLARIS door handle - black matt
inserts in DRE-Cell, 3D and CPL colors
inserts in acrylic laminates



WEGA door handle - satin nickel



WEGA door handle - black matt



ATRIA door handle - satin nickel



ATRIA door handle - black matt



ORION door handle - satin nickel



ORION door handle - black matt



ARCTUS door handle - satin nickel



simple key
backplate



cylinder lock
backplate



backplate for
toilet lock



simple key
backplate



cylinder lock
backplate



backplate for
toilet lock



simple key
backplate



cylinder lock
backplate



backplate for
toilet lock



simple key
backplate



cylinder lock
backplate



backplate for
toilet lock



simple key
backplate



cylinder lock
backplate



backplate for
toilet lock



simple key
backplate



cylinder lock
backplate



backplate for
toilet lock



simple key
backplate



cylinder lock
backplate



backplate for
toilet lock



simple key
backplate



cylinder lock
backplate



backplate for
toilet lock



simple key
backplate



cylinder lock
backplate



backplate for
toilet lock

Door handles



ALTAIR door handle - graphite



AVIOR door handle - glossy chrome



MIMOSA door handle - black matt



ZETA door handle - satin nickel



door handle MEDA - shiny chrome
inserts in DRE-Cell, 3D and CPL colors
inserts in acrylic laminates



QUBIK door handle - black with antibacterial coating *



CUBE SLIM door handle - brushed chrome



the CUBE SLIM handle - shiny brass



door handle IBIZA - black matt



simple key
backplate



cylinder lock
backplate



backplate for
toilet lock



simple key
backplate



cylinder lock
backplate



backplate for
toilet lock



simple key
backplate



cylinder lock
backplate



backplate for
toilet lock



simple key
backplate



cylinder lock
backplate



backplate for
toilet lock



simple key
backplate



cylinder lock
backplate



backplate for
toilet lock



simple key
backplate



cylinder lock
backplate



backplate for
toilet lock*



simple key
backplate



cylinder lock
backplate



backplate for
toilet lock



backplate with
simple key



backplate for
cylinder lock



backplate for
toilet lock



simple key
backplate



cylinder lock
backplate



backplate for
toilet lock

* - the handle and the toilet knobs are covered with an antibacterial coating

Door handles



CUBE door handle - glossy chrome



CUBE door handle - brushed nickel



CUBE door handle - black matt



MONDO door handle - satin nickel



LINEA door handle - nickel satin



ZOJA door handle - brushed brass



handle ZORBA - shiny chrome/satin



QUIK Fit door handle - black



DIVA door handle - black matt



simple key backplate



backplate for cylinder lock



backplate for toilet lock



simple key backplate



backplate for cylinder lock



backplate for toilet lock



simple key backplate



backplate for cylinder lock



backplate for toilet lock



backplate for simple key



backplate for cylinder lock



backplate for toilet lock



backplate for simple key



backplate for cylinder lock



backplate for toilet lock



simple key backplate



cylinder lock backplate



bathroom lock backplate



simple key backplate



backplate for cylinder lock



backplate for toilet lock



simple key backplate



cylinder lock backplate



bathroom lock backplate



simple key backplate



cylinder lock backplate



bathroom lock backplate

Door handles



PROXIMA door handle - stainless steel



simple key
backplate



backplate for
cylinder lock



backplate for
toilet lock



TOPAZ door handle - stainless steel



simple key
backplate



backplate for
cylinder lock



backplate for
toilet lock



TOPAZ door handle - stainless steel, black matt



simple key
backplate



backplate for
cylinder lock



backplate for
toilet lock



handle JOWISZ - stainless steel



backplate for
simple key



backplate for
cylinder lock



backplate for
toilet lock



LUNA SLIM door handle - brushed chrome



simple key
backplate



backplate for
cylinder lock



backplate for
toilet lock



LUNA slim door handle - shiny brass



simple key
backplate



backplate for
cylinder lock



backplate for
toilet lock



door handle IBIZA - nickel satin



backplate for
simple key



backplate for
cylinder lock



backplate for
toilet lock



handle BETA - nickel satin



simple key
backplate



cylinder lock
backplate



backplate for
toilet lock



EUROPA door handle - nickel satin



simple key
backplate



cylinder lock
backplate



backplate for
toilet lock

Door handles



TOMA door handle - black



STARK Fit door handle - black



WARNA handle - satin nickel



NOX slim door handle - black matt, round backplate



NOX slim door handle - black matt, square backplate



EDER door handle - black matt



ALAMBRE door handle - glossy chrome



FOKUS door handle - nickel satin velvet



UNO door handle - stainless steel



simple key backplate



cylinder lock backplate



backplate for toilet lock



simple key backplate



cylinder lock backplate



backplate for toilet lock



simple key backplate



backplate for cylinder lock



backplate for toilet lock



simple key backplate



cylinder lock backplate



bathroom lock backplate



simple key backplate



cylinder lock backplate



bathroom lock backplate



simple key backplate



cylinder lock backplate



bathroom lock backplate



simple key backplate



backplate for cylinder lock



backplate for toilet lock



simple key backplate



cylinder lock backplate



bathroom lock backplate



simple key backplate



backplate for cylinder lock



backplate for toilet lock

Door handles



ROMANA door handle - chrome/lacquered nickel



TIK-QR door handle - anthracite



QUBIK door handle - lacquered nickel



LIBRA door handle - satin nickel



ORGANIC door handle - grey-brown



UNICO door handle - pink gold satin



technical handle STAR TEC - class IV - stainless steel matt price for a set (door handle + cylinder backplate), door leaves thickness up to 55 mm



simple key backplate



cylinder lock backplate



backplate for toilet lock



simple key backplate



cylinder lock backplate



backplate for toilet lock



simple key backplate



cylinder lock backplate



backplate for toilet lock



simple key backplate



cylinder lock backplate



backplate for toilet lock



simple key backplate



cylinder lock backplate



bathroom lock backplate



backplate for simple key



backplate for cylinder lock



backplate for toilet lock



cylinder lock backplate

door handle SZARK for the SOLID / ENTER



door handle SHARK black and inox



backplate SHARK black and inox



door handle DIVA and backplate for door leaves FORCA 10 and FORCA B 10 silver F1 door handle long backplate



ONTARIO door handle and backplate for SOLID RC2 model silver colour F1 door handle long backplate



Door handles

Note: long plates do not fit doors with magnetic locks.

ZORBA door handle with long plate - glossy chrome, spacing 72mm



interior backplate

exterior backplate

NOTE:
selection of left or right door handle*.
Door handle in set with backplate is
adapted to door leaf with two locks
except for SOLID collection.

*left door handle

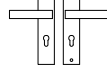

*right door handle

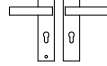

NOTE:
Door handle in set with backplate
is adapted to door leaf SOLID with
two locks.



handle METRO (span 72 mm)
for cylinder lock

upper backplate METRO
stainless steel for cylinder lock



TOTAL door handle
external with
longitudinal backplate (72 mm
spacing)
stainless steel plus



short upper backplate TOTAL
short inox plus

Note: long backplates do not fit doors with magnetic lock

CYLINDER LOCK INSERTS



SELF-CLOSER

DORMA TS-90 impuls self closer
Price.....



DORMA TS-71 selfcloser
Price.....



GEZE TS 2000 selfcloser
Price.....



GLASS



mat dre



decormat graphite



milky laminated VSG 2.2.1, smooth
on both sides



decormat brown



window blind



chinchila



white bark



VSG black



textured



pattern 1 VETRO
transparent



pattern 1 VETRO
decormat



pattern 5 VETRO



pattern 1 VETRO
decormat brown

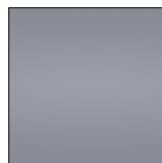

pattern 1 VETRO
decormat graphite



VETRO pattern E
laminated glass
decormat



pattern VETRO E, VETRO D1
black opaque laminated glass



pattern 3 VETRO

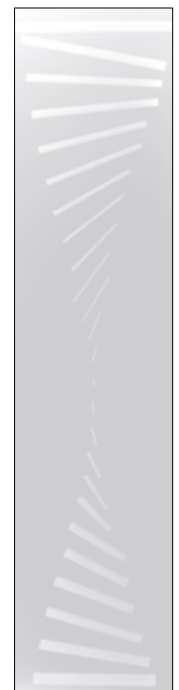

pattern 4 VETRO

PRICES

Prices and availability of glass panes are given on the page next to the door leaf. Glass pane in the doors of our collections has an obverse and reverse side (except VSG 2.2.1 and VETRO E, VETRO D1).

DECORS

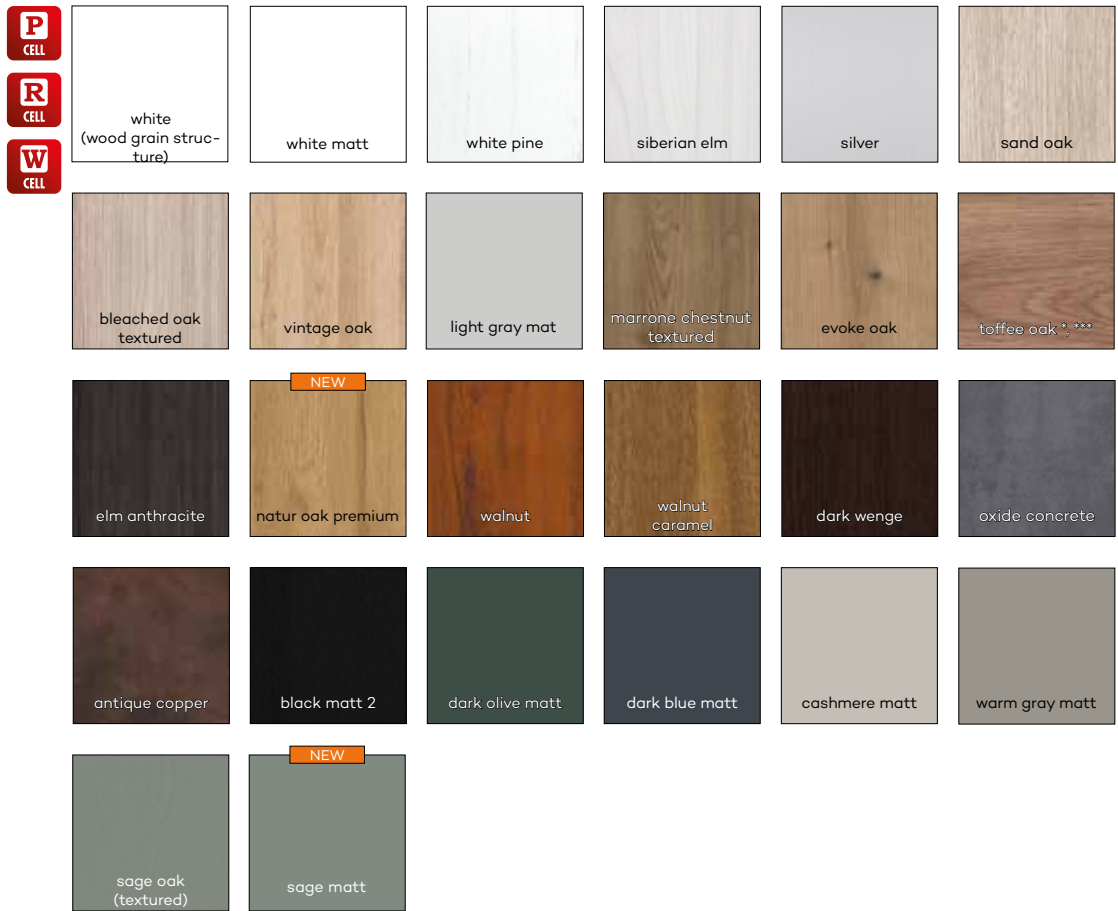

* decor available while stocks last,
 **decor available only in horizontal wood grain



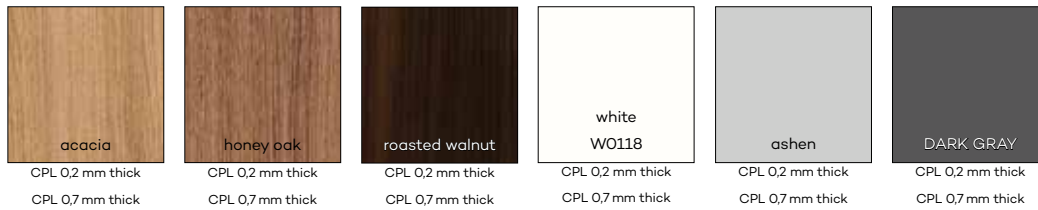

* Black ST decor - Tecofol protected twice with pigmented, matt varnish. Decor assigned to the CPL price group, however, it is not a CPL laminate.

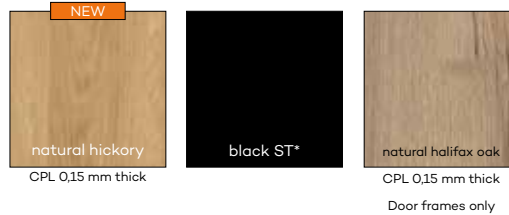

** RAL, NCS, FLUGGER values are approximate values and closest to the color of the door leaf

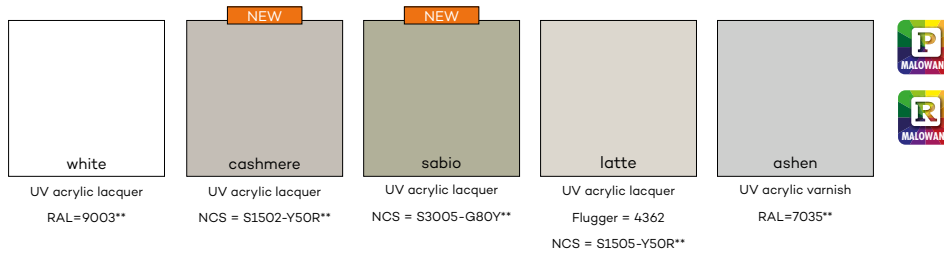

Decors from LUX collection

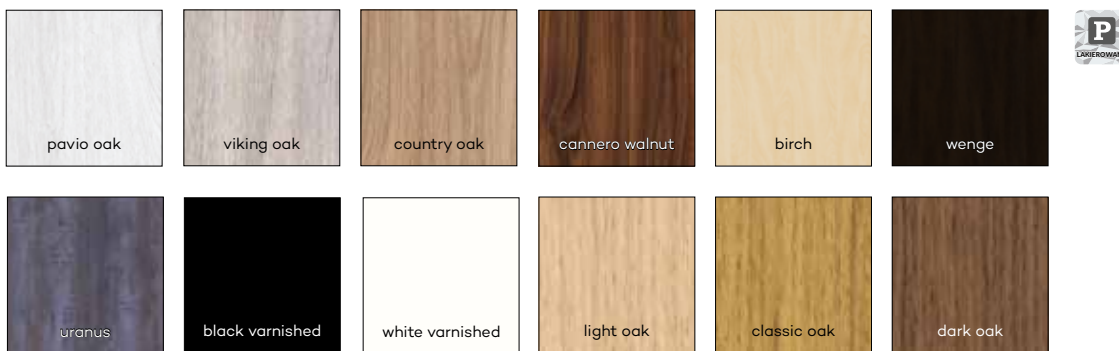

Decors from GRAFI collection

Decors from WOOD collection



Grafi

GRAPHIC PATTERNS



GRAFI M1 G16

* pattern versions available for the right and left door leaf



G1



G2



G3



G4



G5



G6



G7



G8



G9



G10



G11



G12



G13



G14



G15



G16



G17*



G18*



G19



G20*



G21



G22



G23



G24*



G25

DOOR FRAMES MASKING ELEMENTS

KT2 ARCHITRAVE

KT2 architrave 80 mm and 63 mm increases the adjustment range of the standard adjustable door frame by additional 15 mm. It must be ordered additionally as a separate accessory. The price of this architrave is available at Distributor.

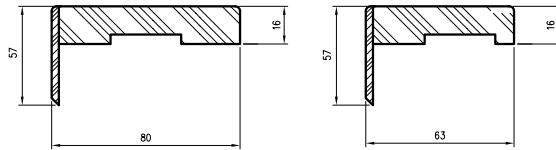

ARCHITRAVES

Application: fixed door frame, fixed door frame SOFT

Contents of the set (for one side of the door): horizontal and two vertical strips, plastic hooks, pins and clamps. The masking architraves are packed in a cardboard box.

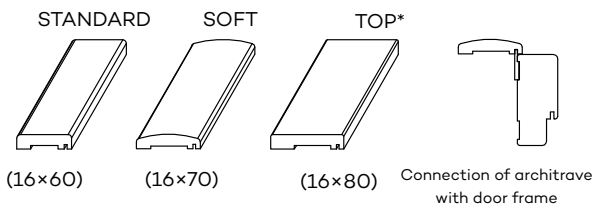

QUARTER ROUNDS

Quarter round is used to cover the angular connection between the wall and the door frame. A single item constitutes a trade unit.

Quarter rounds require cutting before the assembly.

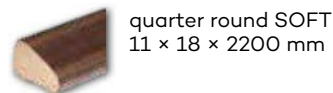
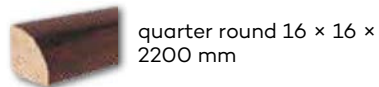

SKIRTING BOARDS



LPP 2W LPP 3W LPP 1W LPP 4W

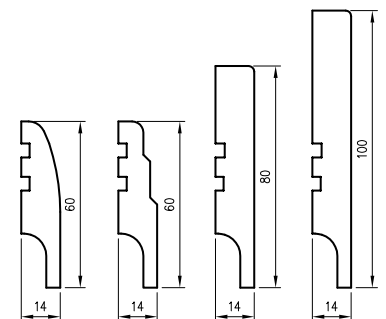

The length of the skirting boards is 2.62 m (except LPP4W). Skirting boards need to be trimmed prior to installation.

Length of LPP4W is 2,40 mb
It is made of moisture resistant board.

VENTILATION GRILLE

There is possibility to instal bathroom plastic ventilation grille, which is available in the following colours: white, beige, calvados, brown, silver, creamy, gray, black and ashen (except for frame construction doors, sliding doors, fire resistant doors and SOLID, ENTER) or aluminum ventilation grille



plastic ventilation grille



aluminum ventilation grille

- plastic ventilation grille
- aluminum ventilation grille

VENTILATION ACCESSORIES AND OTHERS

VENTILATION SLEEVES FOR PANEL DOORS

There is possibility to purchase a set (5 pcs) of ventilation sleeves.
DRE-Cell Decor, 3D foil, CPL laminate.



white ashen creamy oak walnut light calvados brown gray black



VENTILATION SLEEVES FOR FRAME CONSTRUCTION DOOR LEAF

For frame construction doors, except for VETRO with plastic sleeves (3 sleeves for doors "60", 4 sleeves for doors "70", 5 sleeves for doors "80"- "100")

PLASTIC VENTILATION SLEEVES



VENTILATION UNDERCUT

In all collections (except SOLID, SOLID RC2, ENTER, FIRE resistant door leaves, sliding doors, folding), ventilation undercut can be made upon request.



ventilation undercut

13.5 MM HINGE FOR REBATED DOORS

- (set of lower and upper part)
13.5 mm diameter hinge in black.



HINGE COVERS

- (set consist of 2 pcs. for 1 hinge)
Plastic hinge covers are adjusted to hinges with diameter of 13.5 mm.

- thimble (price for 1 pcs.)



gold glossy chrome glossy chrome matt black white



gold gold matt chrome chrome matt black

TECHNICAL INFORMATIONS

TYPES OF DOOR LEAF EDGES

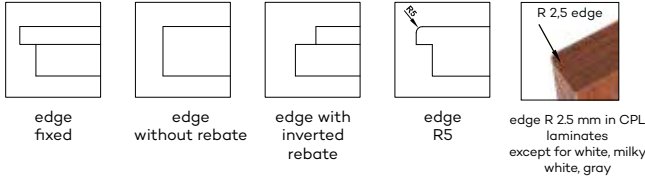

TYPES OF GLAZING FRAMES AND PANELS

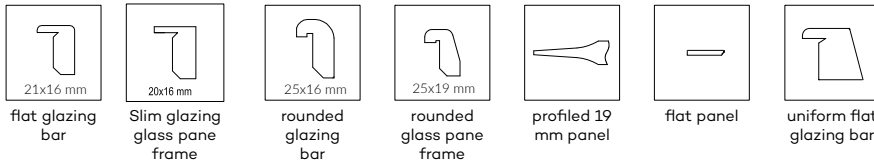

TECHNICAL INFORMATION - VETRO E SYNCHRONOUS LAMINATES, PAINTED

Horizontal cross-section of rebated VETRO E doors

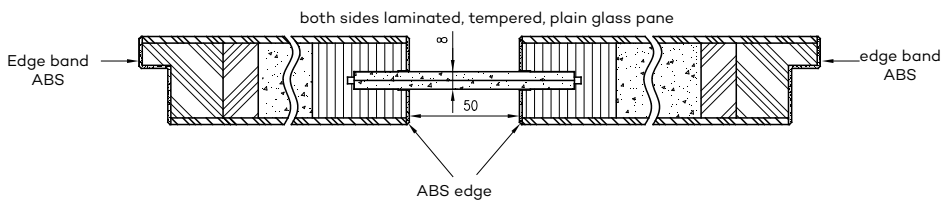

Horizontal cross-section of non-rebated VETRO E doors

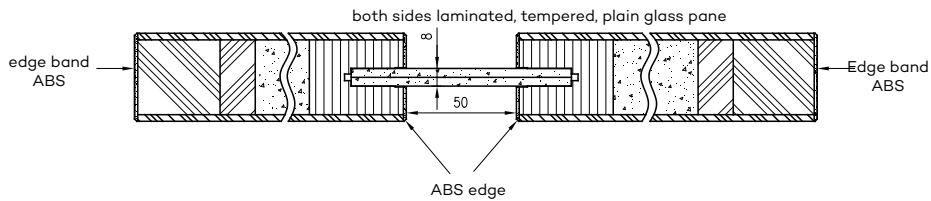

TECHNICAL INFORMATION - ESTRA

ESTRA 10 doors with inverted rebate in the "Obverse" variant

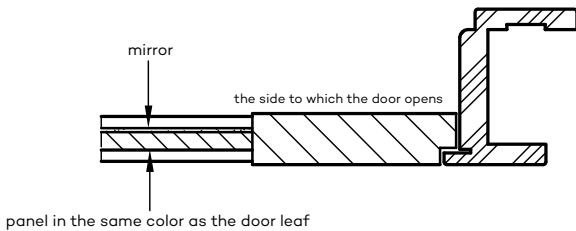

ESTRA 10 door with inverted rebate in the "Reverse" variant

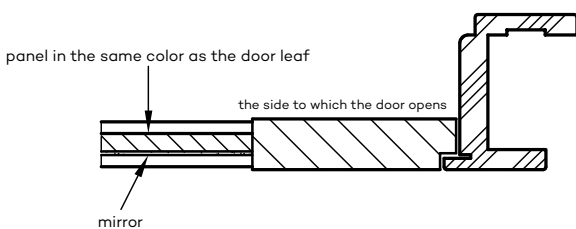

ESTRA 10 doors, non-rebated or rebated, in the "Obverse" variant

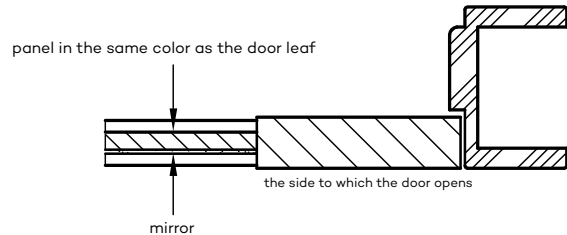

ESTRA 10 doors, non-rebated or rebated, in the "Reverse" variant

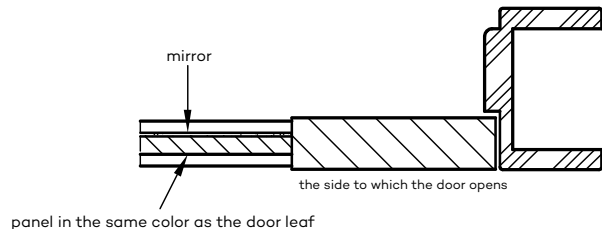

TECHNICAL INFORMATIONS

TECHNICAL INFORMATION - VETRO A, B, D1

NOTE: In white matt color the door leaves are also available in non-rebated door leaf.

cross-section of stile in non-rebated door leaf

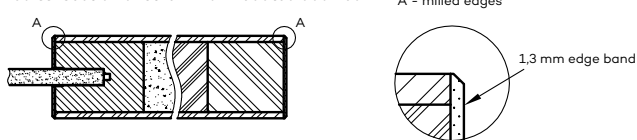

VETRO collection glass panes have obverse and reverse sides (important in two door leaves opening inversely). Presented horizontal cross-sections show the arrangement of glass pane in the obverse version. When choosing a reverse version, glass pane is rotated by 180° around the vertical axis.

Horizontal cross-section of doors A1-A4, B1-B4, D1

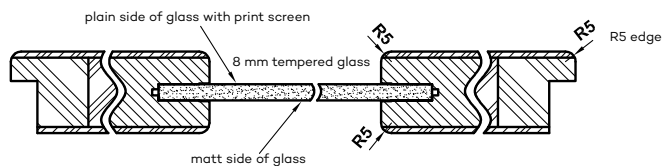

Horizontal cross-section of VETRO A5, B5, D1 door

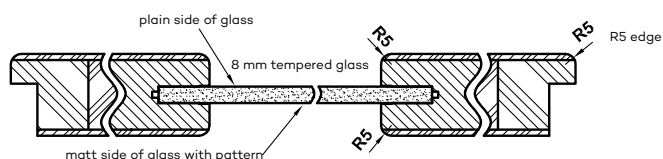

WALL-MOUNTED SLIDING SYSTEM

masking strip with guide bar

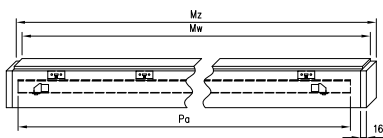

Single sliding system

Dimension	Masking strip		Guide bar
	Mz	Mw	Pa
door [mm]			
644, 744	1620	1588	1500
844	1920	1888	1800
944	2120	2088	2000
1044	2160	2128	2000

double leaf door sliding system

Dimension	Masking strip		Guide bar
	Mz	Mw	Pa
door [mm]			
2 x 644	2 x 1519	2 x 1503	2 x 1500
2 x 744	2 x 1519	2 x 1503	2 x 1500
2 x 844	2 x 1819	2 x 1803	2 x 1800
2 x 944	2 x 2019	2 x 2003	2 x 2000
2 x 1044	2 x 2063	2 x 2047	2 x 2000

Single sliding system

symbol	"60"	"70"	"80"	"90"	"100"
A	602	702	802	902	1002
C	646	746	846	946	1046
D	664	764	864	964	1064
E	752	852	952	1052	1152
E*	786	886	986	1086	1186
S	644	744	844	944	1044

NS - vertical cross-section

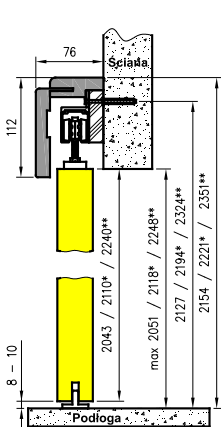

NT - vertical cross-section for tunnel with 63 mm architrave

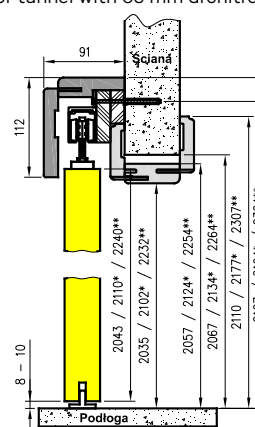

NT - vertical cross-section for tunnel with 80 mm architrave

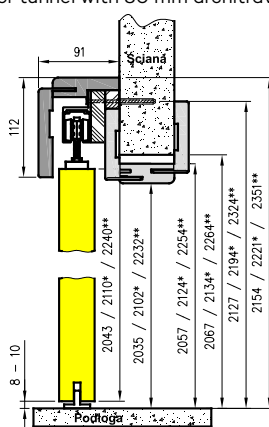

Standard dimensions height 2043, * for the standard height 211X, ** for the standard height 224X

NS - horizontal cross-section (left system)

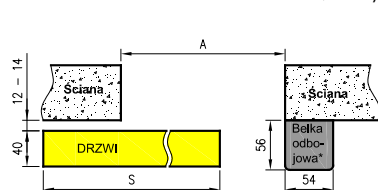

NT - horizontal cross-section (left system)

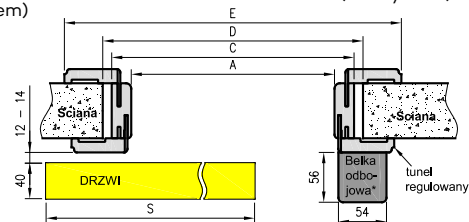

double leaf sliding system

symbol	"120"	"140"	"160"	"180"	"200"
A	1200	1400	1600	1800	2000
C	1244	1444	1644	1844	2044
D	1264	1464	1664	1864	2064
E	1350	1550	1750	1950	2150
E*	1384	1584	1784	1984	2184
S**	644	744	844	944	1044

* is not available in double leaf system

E* applies to tunnel with T80 architrave
S** width of single leaf door

TECHNICAL INFORMATIONS

PROFI - NON-REBATED - OPENING OUTWARDS IN ACCORDANCE WITH THE 2043, 2240 STANDARD

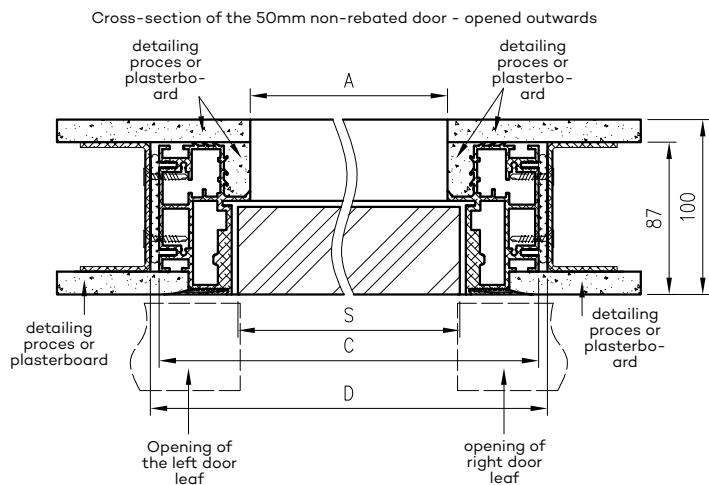

Vertical section of 50mm non-rebated door opened outwards

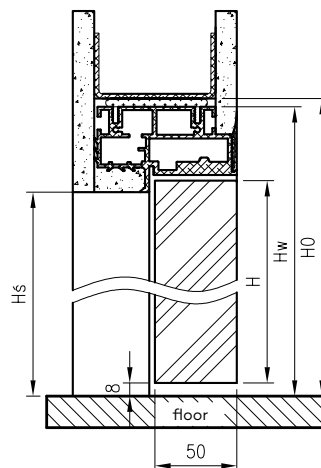

Profi door width dimensions

	S	A	C	D
"60"	600	586	690	700
"70"	700	686	790	800
"80"	800	786	890	900
"90"	900	886	990	1000
"100"	1000	986	1090	1100

Dimensions of non-rebated door leaves

standard	H	H _S	hw	H ₀
2043	2043	2044	2096	2101
2240	2240	2241	2293	2298

PROFI - INVERTED REBATE - OPENING INWARDS IN ACCORDANCE WITH THE 2043, 2240 STANDARD

Cross-section of 50mm inverted rebate door - opened inwards

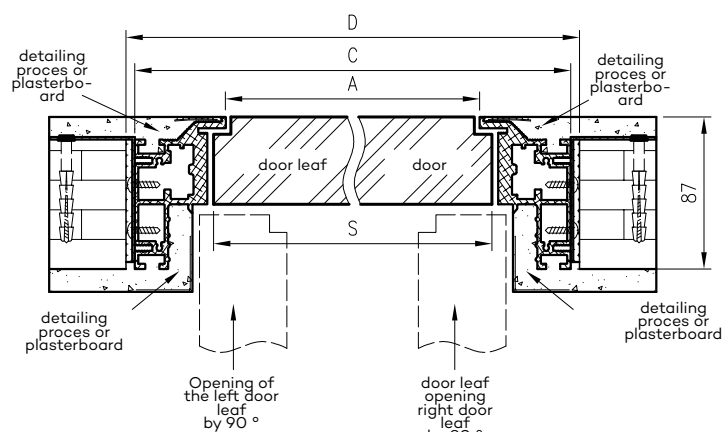

Vertical section of 50mm inverted rebate door - opened inwards

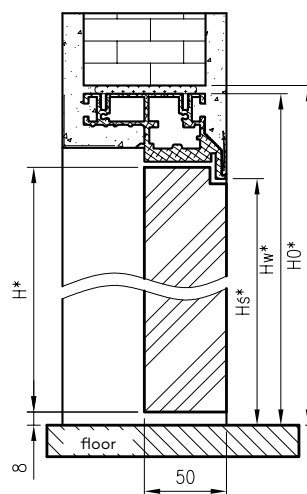

Profi door width dimensions

	S	A	C	D
"60"	600	586	690	700
"70"	700	686	790	800
"80"	800	786	890	900
"90"	900	886	990	1000
"100"	1000	986	1090	1100

height dimensions of rebated doors

stan- dard	H	H _S	hw	H ₀
2043	2053	2054	2106	2111
2240	2250	2251	2303	2308

- S - door leaf width
- A - width of passage in door frame unit
- C - external width of door frame
- D - required width of wall opening
- H₀ - height of the wall opening

TECHNICAL INFORMATIONS

SARA ECO 2 - NON-REBATED - OUTWARD OPENING DRE DOOR FRAME

Cross-section for Sara Eco2 non-rebated doors opened outwards

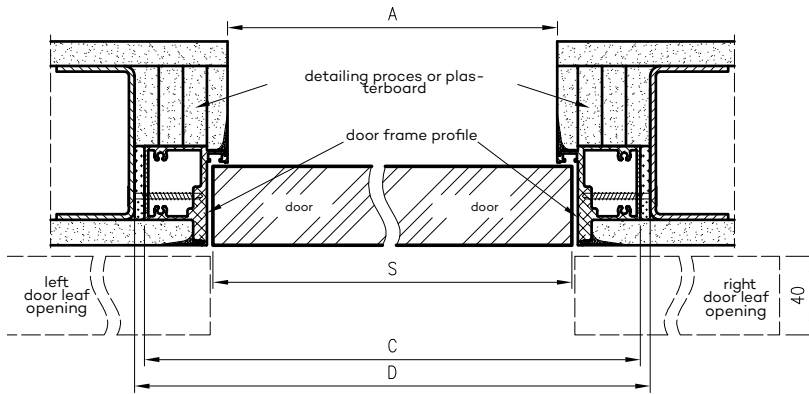

Dimensions of the door leaf width Sara Eco 2

	S	A	C	D
"60"	620	605	690	700
"70"	720	705	790	800
"80"	820	805	890	900
"90"	920	905	990	1000
"100"	1020	1005	1090	1100

height dimensions of rebated doors

stan- dard	H	H ^š	hw	H ⁰
202x	2020	2020	2062	2070
220X	2200	2200	2242	2250
240X	2400	2400	2442	2450

Vertical cross-section for Sara Eco 2 door non-rebated - opening outwards

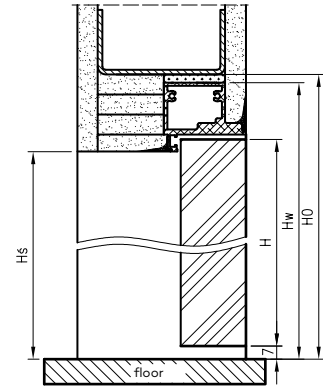

DRE profile for non-rebated outward opening doors

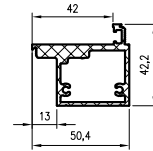

SARA ECO 2 - INVERTED REBATE - INWARD OPENING DRE DOOR FRAME

Cross-section of Sara Eco 2 with inverted rebate - opened inwards

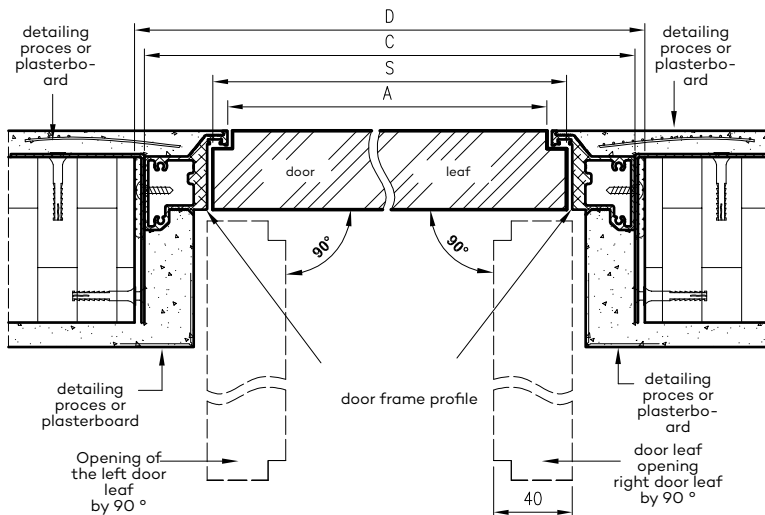

Dimensions of the door leaf width Sara Eco 2

	S	A	C	D
"60"	620	605	690	700
"70"	720	705	790	800
"80"	820	805	890	900
"90"	920	905	990	1000
"100"	1020	1005	1090	1100

S - door leaf width
 A - width of passage in door frame unit
 C - external width of door frame
 D - required width of wall opening

height dimensions of rebated doors

stan- dard	H*	H ^š *	Hw*	H ⁰ *
202x	2030	2030	2072	2080
220X	2210	2210	2252	2260
240X	2410	2410	2452	2460

Vertical section of Sara Eco 2 with inverted rebate - opened inwards

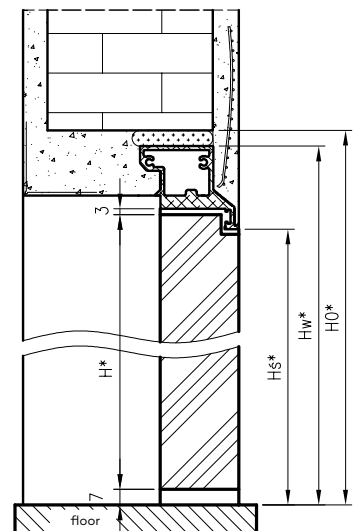

DRE profile for doors with inverted rebate opened inwards

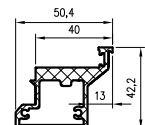

TECHNICAL INFORMATIONS

WOODEN DOOR FRAME FOR ATHOS EI 30

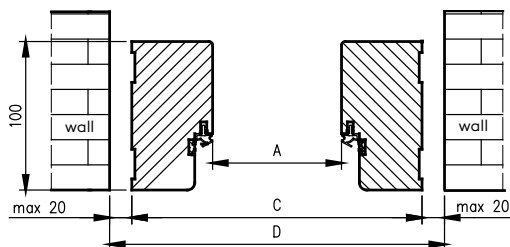

OD (wooden door frame) dimensions for Athos doors

width.	A	C	D
"80"	802	910	934
"90"	902	1010	1034
"90E"	917	1025	1049
"100"	1002	1110	1134
"110"	1102	1210	1234

D - width of the assembly hole

Wooden door frame for Athos door with a fixed threshold

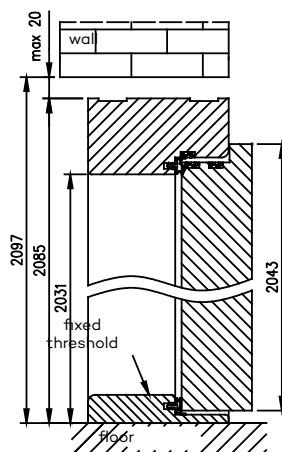

Wooden door frame for Athos door with dropping seal *

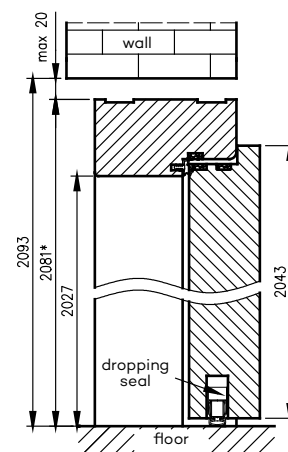

FIRE-RESISTANT WOODEN DOOR FRAME FOR OLIMP EI 30, EI 60

horizontal cross-section of door frame in the wall

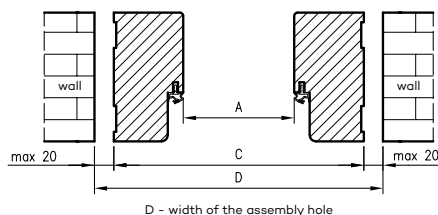

D - width of the assembly hole

OD OLIMP EI30 wooden door frame for single-leaf doors

	A	C	D
80	802	910	934
90	902	1010	1034
90E	917	1025	1049
100	1002	1110	1134
110	1102	1210	1234

OD OLIMP EI60 wooden door frame for single-leaf doors

	A	C	D
80	804	912	936
90	904	1012	1036
90E	933	1041	1065
100	1004	1112	1136
110	1104	1212	1236

Cross-section of the wooden door frame for OLIMP EI30 doors

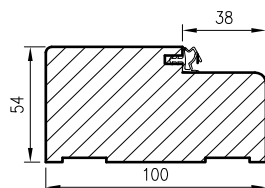

Cross-section of the wooden door frame for OLIMP EI60 doors

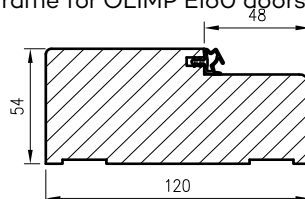

vertical cross-section of fire-resistance door leaf.

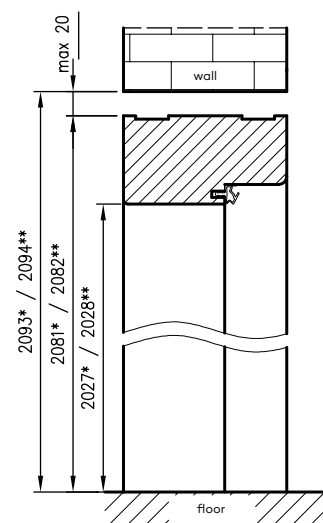

* dimensions of OD OLIMP EI 30 wooden door frame
 ** dimensions of OD OLIMP EI 60 wooden door frame

TECHNICAL INFORMATION

STEEL FIXED DOOR FRAME FOR OLIMP EI 60

OLIMP EI-60 door leaf vertical cross-section

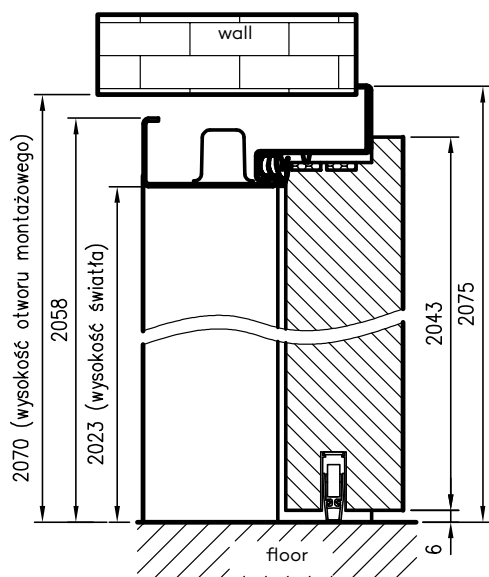

horizontal cross-section of door frame mounted in the wall

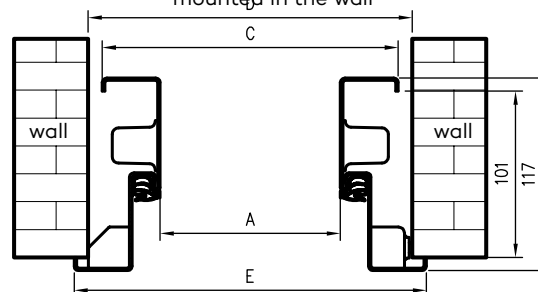

D - width of the assembly hole

door frame profile

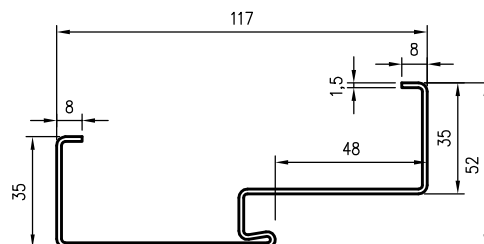

Olimp EI60 dimensions for single leaf doors

	A	C	D	E
"80"	797	867	884	901
"90"	897	967	984	1001
"90E"	926	996	1013	1030
"100"	997	1067	1084	1101
"110"	1097	1167	1184	1201



threefold hinge



Hinge SIMONSWERK VX 7939/160 (for door widths "100" and "110")

FIXED DOOR FRAME PROFILES OP, OP SOFT, OPB

OP (fixed door frame) profile

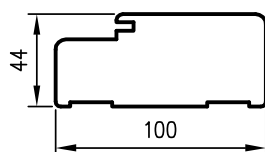

OP SOFT (fixed door frame SOFT) profile

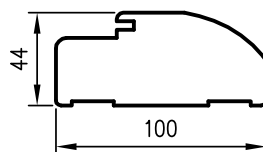

OPB profile

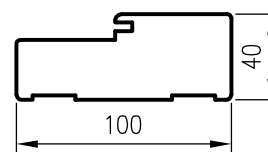

TECHNICAL INFORMATIONS

DOOR LEAF DIMENSION AND PLACEMENT OF HINGES

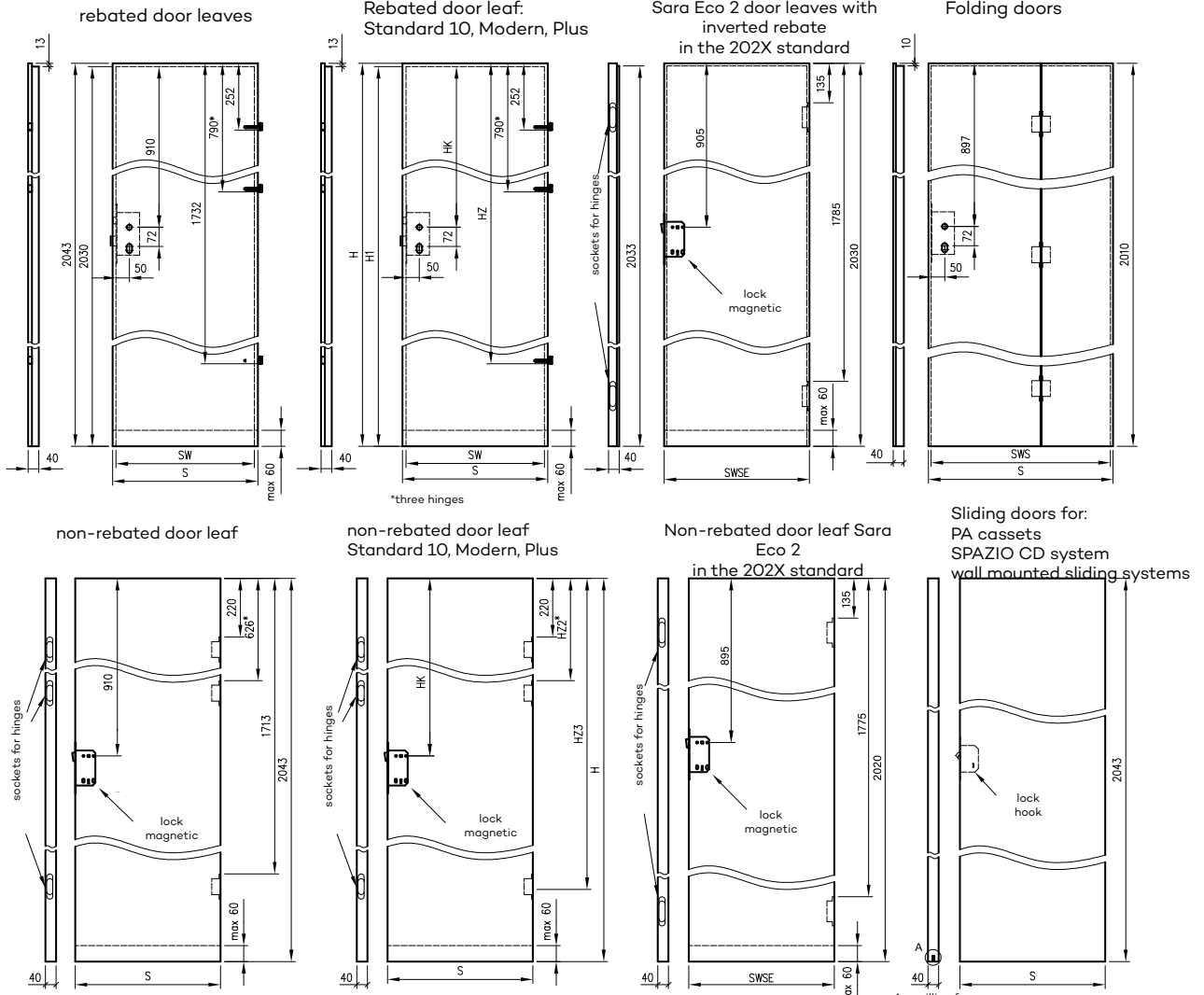

* in case

Note: magnetic locks in two variants of spacing: 85mm for a cylinder lock insert or 90mm for a simple key and toilet lock insert

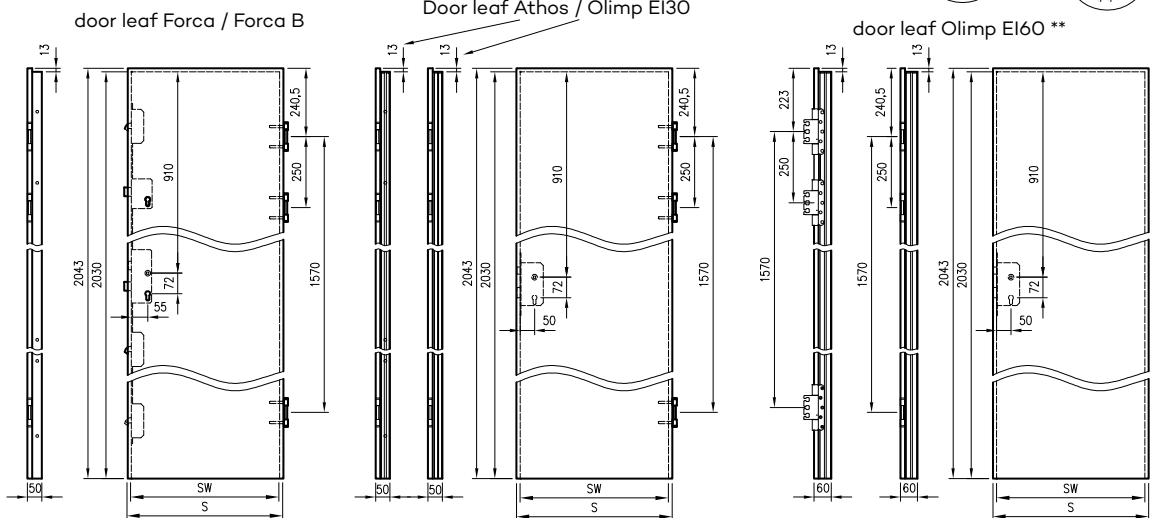
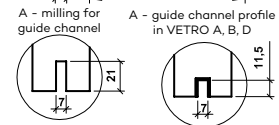

** Olimp EI60 two options of hinges (depending on the width of the door)

TECHNICAL INFORMATIONS

DOOR LEAF WIDTH

Symbol of the door dimension	S	SW	SWSE	SWS
"60"	644	618	620	,-
"60N"	624	,-	,-	,-
"70"	744	718	720	,-
"70N"	724	,-	,-	,-
"80"	844	818	820	824
"80N"	824	,-	,-	,-
"90"	944	918	920	924
"90N"	924	,-	,-	,-
"100"	1044	1018	1020	1024
"100N"	1024	,-	,-	,-
"110"	1144	1118	,-	,-

"xN" - width standard for selected single-leaf non-rebated panel construction door leaves in the 2043 standard

S - total door leaf width
 SW - width in the rebate (refers to rebated door leaf)
 SWSE - Sara Eco 2 leaf width
 SWS - width in the rebate of folding door leaf
 * - width "110" is only available in door leaves Standard 10, Athos, Enter Acoustic and Olimp

NOTE: Total width of "40" side panels is 444 mm.

ADDITIONAL LEAF WIDTHS

Symbol of the door dimension	S	SW
"90E" for OLIMP EI30, ATHOS, FORCA, FORCA B.	959	933
"90E" for OLIMP EI60	973	947
"90E" for STANDARD, ENTER, ENTER AKUSTIK, SOLID, SOLID RC2	948	922

The investment standard "90E" provides 900mm passage in the door frame with the door leaf opened at an angle of 90 degrees

DIMENSIONS OF THE DOOR LEAF WITH 4 VARIABLE HEIGHTS

(refers to door leaf STANDARD 10 and collections MODERN and PLUS)

H	H1	HK	HZ	HZ2	HZ3
1983	1970	850	1672	606	1653
2043	2030	910	1732	626	1713
2110	2097	977	1799	647	1780
2240	2227	1107	1929	691	1910

H - total height of the door leaf
 H1 - door leaf height in the rebate
 HK - distance from the top rebate of door leaf to the axis of the handle
 HZ - distance from the upper edge of the door leaf to the mounting point of the third hinge

DOOR LEAF HEIGHT

2043 mm - total height of rebated and non-rebated door leaf (2010 for folding doors)
 2030 mm - height of the rebated door leaves in the rebate (2020 for Sara Eco 2 door leaves with the inverted rebate, 2000 for folded doors)
 2055 mm - total height of the door leaves with inverted rebate
 1983, 2043, 2110, 2240 mm - total possible height of STANDARD 10 door leaf and MODERN and PLUS collection (1970, 2030, 2097, 2227 mm - measured in the door leaf rebate)

SHORTENING OF DOOR LEAF

There is possibility to shorten door leaf by your own, up to 60 mm (there is no possibility to shorten following door leaf: VETRO, FIRE RESISTANT DOORS, FORCA B, door leaf of all collections in the sliding version, passive doors, glass doors, folding doors and door leaves with dropping seal).

NOTE: The door leaf after recuperative undercut - 8 mm, is adapted to be shortened by oneself, by a maximum of 52 mm.

CLEARANCE BETWEEN DOOR LEAF AND FLOOR

standard clearance between door leaf and finished floor is 8 mm high (15 mm in FOLDE door leaf, 5-6 mm in OLIMP door leaf).

NOTES REFERED TO HINGE

In rebated door leaf: frame construction doors, entrance (Enter, Enter Acoustic, Solid) and in the other collections with size wider than "90", 3 screw-in pivot hinges of \varnothing 13,5 mm are mounted. For other interior rebated leaves, there is possibility to choose 2 or 3 hinges.

In SOLID RC2, FORCA, FORCA B, ATHOS and OLIMP EI30 door leaf there are mounted 3 threefold hinges.

The OLIMP EI60 leaves, depending on the width, are equipped with 3 three-part hinges or 3 SIMONSWERK hinges VX 7939/160.

Non-rebated door leaf come with pre-milled sockets for two or three hidden concealed hinges which are attached together with non-rebated door frame.

Sara Eco 2 door leaves with inverted rebate and non-rebated doors have milled sockets for recessed hinges, which are packed together with the door frame.

Folding doors come with 3 hidden recessed hinges which join two parts of door leaf.

Door leaves with inverted rebate have sockets for two concealed hinges, which are packed together with door frame.

Non-rebated door leaf



edge without rebate



magnetic lock



recessed hinge

REBATED DOOR LEAF



fixed edge



screw-in hinge



threefold hinge



deadbolt lock upper

TECHNICAL INFORMATIONS

DOOR LEAF THICKNESS AND SELECTION OF CYLINDER INSERT

Door leaf type	Door leaf thickness	proportion in the door leaf (WO/ZO)	reccommended** dimension of the cylinder insert (W/Z)	Refers to cylinder insert with door knob	
				Cylinder insert with a knob on the inside (W/Z)	Cylinder Insert with a door knob outside (W/Z)
rebated door leaf	40	14 / 26	25 / 40 ; 26 / 36 26 / 41 ; 30 / 40	25G/40; 26G/36 26G/41; 30G/40 27G/40	25/40G; 26/36G 26/41G; 30/40G 27/40G
Sara Eco 2 inverted rebate door leaves	40	24 / 16	35 / 30 ; 36 / 26 36 / 31 ; 40 / 30	35G/30; 36G/26 36G/31; 40G/30	35/30G; 36/26G 36/31G; 40/30G
Non-rebated door leaf	40	20 / 20	31 / 31 ; 30 / 30 35 / 35	31G/31; 30G/30 35G / 35	
Profi non-rebated door leaves	50	25/25	35/35; 36/36 40/40; 41/41	35G/35 ; 36G/36 41G/41 ; 40G/40	
Non-rebated door leaf Sara Eco 2	40	16 / 24	30 / 35 ; 26 / 36 31 / 36 ; 30 / 40	30G/35; 26G/36 31G/36; 30G/40	30/35G; 26/36G 31/36G; 30/40G
Door leaf with inverted rebate	40	27 / 13	40 / 25 ; 41 / 26	40G/25; 41G/26	40/25G; 41/26G
Profi Door leaf with inverted rebate	50	30/20	40/30; 41/31 45/35	40G/30 ; 41G/31 45G/35	40/30G ; 41/31G 45/35G
Folding doors	40	17/23	30/35; 31/36 30/40	30G/35; 31G/36 30G / 40	30/35G; 31/36G 30 / 40G
fire resistance Athos	50	21 / 29	31 / 41 ; 35 / 40	31G/41; 35G/40	31/41G; 35/40G
Olimp EI30	50	18 / 32	30 / 45 ; 31 / 46	30G/45; 31G/46	30/45G; 31/46G
Olimp EI60	60	28 / 32	40 / 45 ; 41 / 46	40G/45; 41G/46	40/45G; 41 / 46G
fire resistance FORCA	50	22 / 28	35 / 40		
SOLID RC2	40,6	14 / 26,6	26 / 40 ; 26 / 41 30 / 40		

Cylinder inserts are reversible - that is 25/40 = 40/25, 26G/36 = 36/26G

**reccommended dimensions (assuming that backplate is 10 mm thick, and patented cylinder doesnt exceed 5 mm above backplate).

Fig. Selection of the cylinder insert dimensions

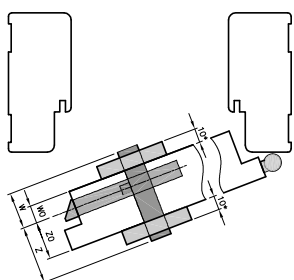
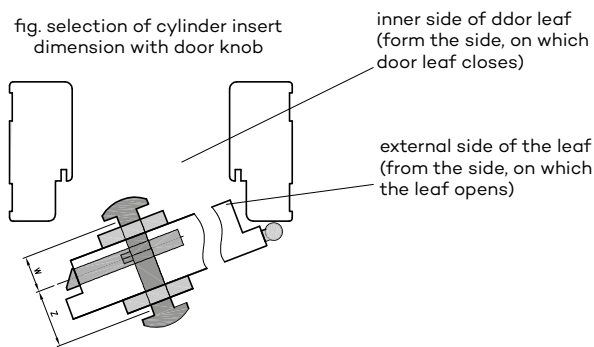

fig. selection of cylinder insert dimension with door knob



Dimension of cylinder insert is calculated using the following formula:

$$WO + \text{backplate thickness} + 2 \times 3\text{mm} / ZO + \text{backplate thickness} + 2 \times 3\text{mm}$$

where:

WO and ZO - values have been presented in the table above
thickness of the backplate - measured (presented values in above table assume that backplate is 10mm thick)

Selection of backplate with door knob - if we want to mount a knob on:

- the inner side of door leaf - symbol of the door knob must be next to "W" dimension (see column 5 in the table)

- the external side of the leaf - symbol of the door knob must be next to "Z" dimension (see column 6 in the table)

SINGLE LEAF REBATED DOOR

We offer left, right and central door leaf

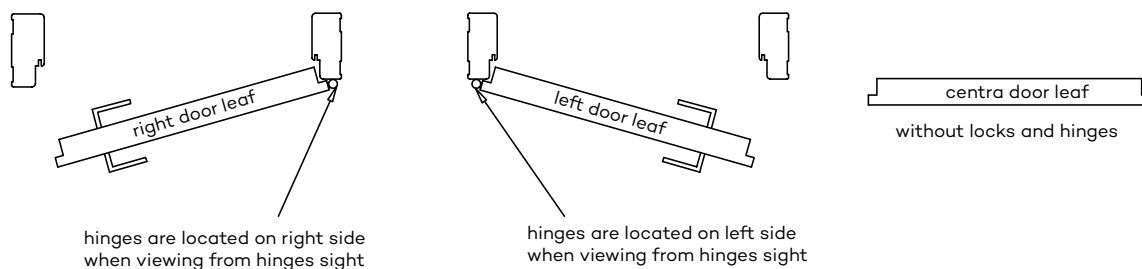

TECHNICAL INFORMATIONS

DOUBLE LEAF REBATED DOOR

We offer double leaf doors: the right - then right door leaf becomes an active one and left door leaf becomes passive, and double left leaf - left leaf is an active one and the right one is passive.

An active door leaf has a rebate and a lock as a standard option. In double leaf door there is available only straight edge.

Inactive door leaf comes with a "counter rebate" and additionally is equipped with a latch strike plate and a flush bolt as a standard fitting (A)

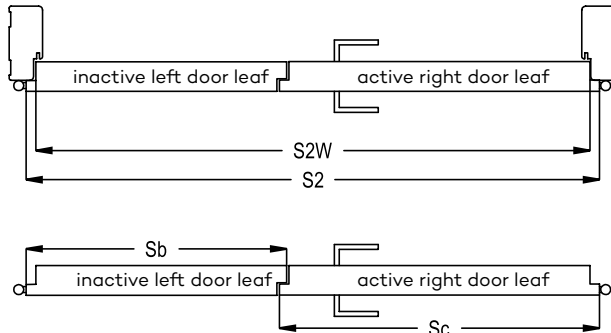

flush bolt (A)

Only door frames produced by DRE fit double-leaf doors, that is the reason that we recommend to our customers to buy doors as a complementary sets.

Whole DRE set comprises of 2 door leaf and door frame.

$$\text{price of double leaf door} = \text{leaf price} \times 2 + \text{price of the fire resistance}$$

Symbol of door dimension	dimension in [mm]		
	S2	S2W	combination* Sc+Sb
„100d”	1078	1052	644+444
„110d”	1178	1152	744+444
”120”	1278	1252	844+444; 644+644
”130”	1378	1352	944+444; 744+644; 644+744
”140”	1478	1452	1044+444; 844+644; 744+744; 644+844
”150”	1578	1552	944+644; 844+744; 744+844; 644+944
”160”	1678	1652	1044+644; 944+744; 844+844; 744+944; 644+1044
”170”	1778	1752	1044+744; 944+844; 844+944; 744+1044
”180”	1878	1852	1044+844; 944+944; 844+1044
”190”	1978	1952	1044+944; 944+1044
”200”	2078	2052	1044+1044

combination* possible combination of active (Sc) and inactive (Sb) leaf width

NON-REBATED DOOR LEAF - SLIDING VERSION

We offer left, right and central door leaf (door leaf without a lock and handle)

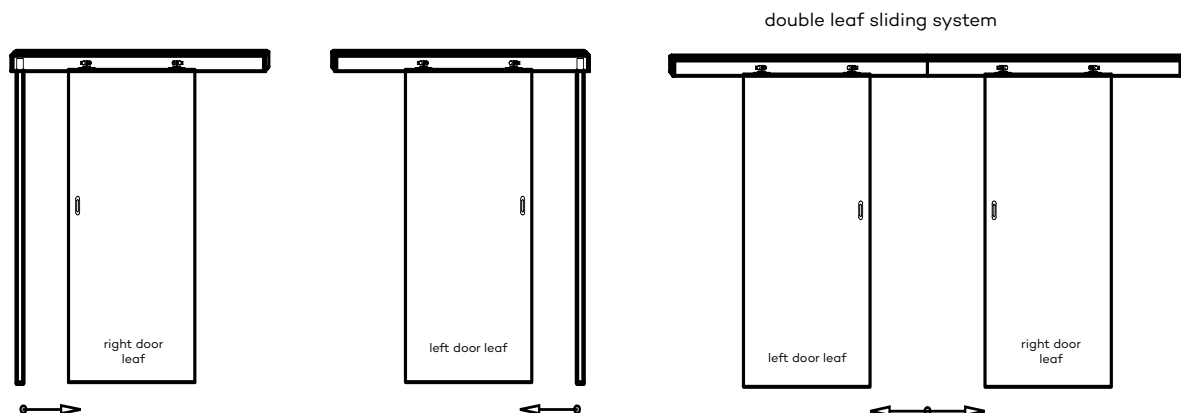

when active leaf is equipped with lock non-active leaf is equipped with latch strike plate

TECHNICAL INFORMATIONS

SINGLE LEAF DOOR NON-REBATED

We offer left, right and central door leaf

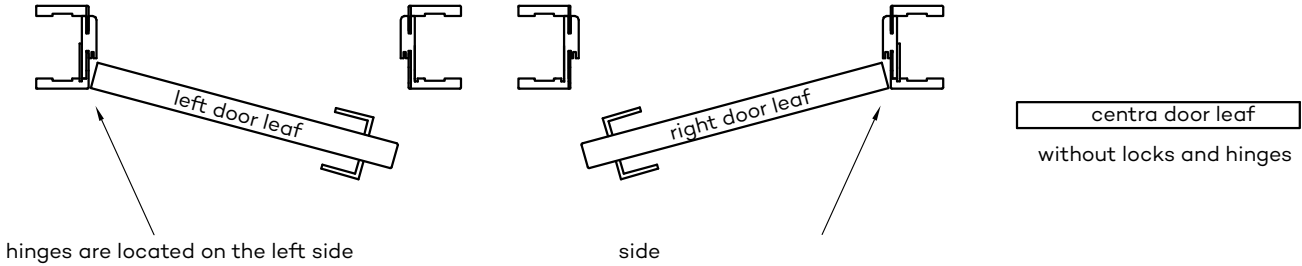

hinges are located on the left side

side

when viewing from the side of the room (door leaf unit is opened towards opening direction)

NOTE: the mechanical lock option for non-rebated doors is only available for single-leaf doors

DOUBLE LEAF NON-REBATED DOOR

We offer double leaf doors: the right - then right door leaf becomes an active one and left door leaf becomes passive, and double left leaf - left leaf is an active one and the right one is passive.

An active door leaf has lock as a standard option. Inactive door leaf is equipped with a latch strike plate and a flush bolt as a standard fitting.

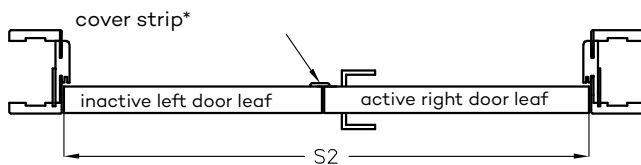

* for double leaf non-rebated doors there is possibility to purchase cover stripe width of cover stripe 30 mm

$$\boxed{\text{price of double leaf door}} = \boxed{\text{leaf price} \times 2} + \boxed{\text{price of the fire resistance}}$$

Symbol of door dimension	dimension in [mm]	
	S2	combination* Sc+Sb
"120"	1291	644+644
"130"	1391	744+644; 644+744
"140"	1491	844+644; 744+744; 644+844
"150"	1591	944+644; 844+744; 744+844; 644+944
"160"	1691	1044+644; 944+744; 844+844; 744+944; 644+1044
"170"	1791	1044+744; 944+844; 844+944; 744+1044
"180"	1891	1044+844; 944+944; 844+1044

combination* - possible combination of active (Sc) and inactive (Sb) leaf width

CONSTRUCTION OF PANEL DOORS

- door leaf frame made of coniferous wood or MDF
- Core: stabilizing insert "honeycomb" (A), perforated chipboard (B) and in fire proof doors: chipboard
- 3 mm HDF external board or 4 mm HDF external board (Finea, Finea B, Enter, Enter Akustik, Solid)
- type of edge straight or without rebate

External boards of door leaf is finished with:

- in DRE-Cell decor collection - decorative foil based on the polypropylene
- in 3D foil - 3D foil based on decorative paper
- in CPL laminate - CPL laminate th. 0.15-0.2mm or 0.7 mm



A. Stabilizing insert "honeycomb"



B. Tubular chipboard

Fire resistant door leaf Olimp EI30

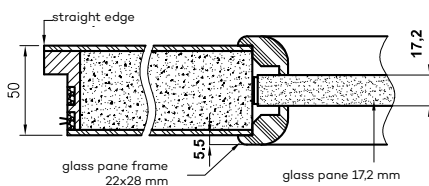

Fire resistant door leaf Olimp EI60

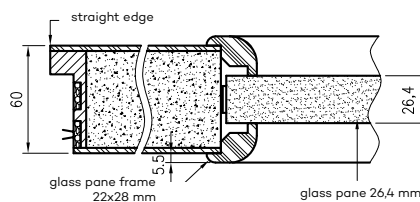

Anti-burglary door and fire-resistant door leaf Forca EI30

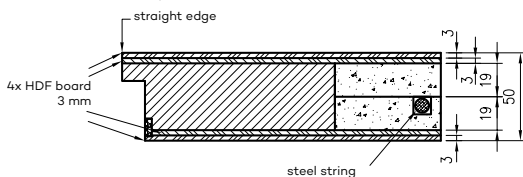

Anti-burglary door leaf Forca B

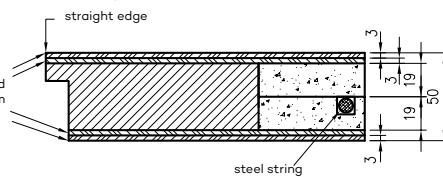

TECHNICAL INFORMATIONS

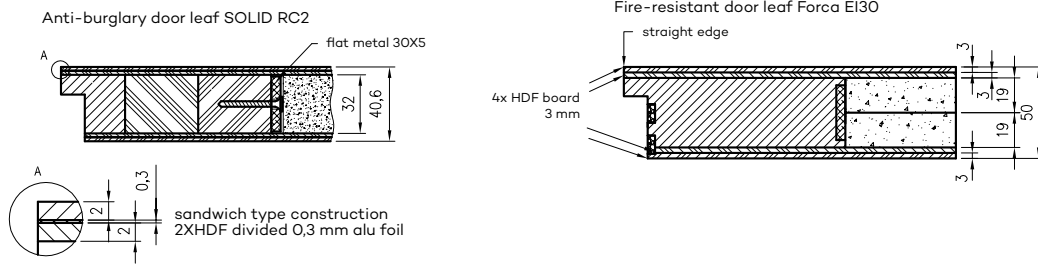

THE CONSTRUCTION OF FRAME DOOR LEAVES (DOES NOT APPLY TO VETRO A, B, D COLLECTIONS)

Frame construction door leaf is entirely made of wood-based panels:

vertical stiles made of wood-based panels - 40 mm

external horizontal stiles made of wood-based panels - 35 mm

horizontal rails (interior):

- wood-based panels - 22 mm in Lumio, Vico, Auri, Piano, Even, Premium, Fosca, Verso, Reva, Solte, Triesta*, Ena*, Verano* door leaves (*in Ena 1-2, Triesta 1-2, 1-2, Verano 1-2, a glass pane frame by the large glass pane made of wood-based panels - 35 mm, while in the Ena 3-5, Verano 3-5, 3-5 and Triesta 3, two glass pane frames by the large glass panes made of wood-based panels - 35mm.)
- wood-based panels - 35 mm in Nestor, Elsa, Scala, Berge, Estrada door leaves.

Horizontal cross-section of door leaf Lumio, Vico, Auri, Verano, Piano, Premium, Fosca, Verso, Ena, Even, Triesta, Reva, Solte

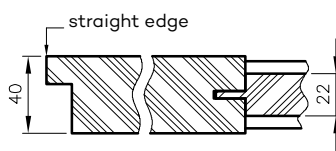

Horizontal cross-section of ELSA

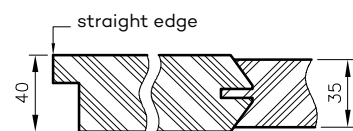

Horizontal cross-section of Ena, Verano and Trieste doors (cross-section at the height of the rail and stile set by the large glass pane)

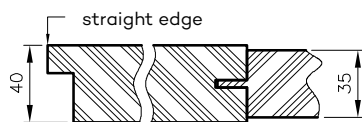

Horizontal cross-section of Nestor

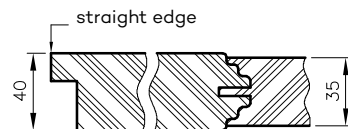

Horizontal cross section of the door leaf Scala, Berge

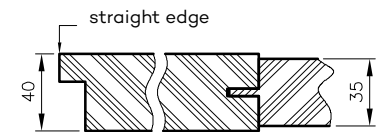

FILLINGS OF FRAME CONSTRUCTION DOOR LEAF:

Scala A; - 4 mm glass pane, flat 4 mm HDF board

Scala B - 4 mm glass pane, 19 mm MDF profiled board

Elsa A - 4 mm glass pane, flat 4 mm HDF board

Elsa B - 4 mm glass pane, 19 mm MDF profiled board

Premium 1-3 - 4 mm glass pane

Premium 4-7, 12 - 4 mm glass pane, 4 mm HDF marquetrys made in door leaf colour

Premium 8-11, 13 - 4 mm glass pane, 4 mm HDF marquetrys coated with silver laminate

Piano 1-6 - 4 mm glass pane, 16 mm MDF profiled board

Piano 9-12 - 4 mm glass pane, 19 mm MDF profiled board

Fosca 1-3 - 4 mm glass pane, 4 mm HDF board coated with silver laminate

Fosca 4-6 - 4 mm HDF board coated with veneer in door leaf colour

Nestor, Berge - 4 mm glass, 19 mm profiled MDF panel

Ena, Trieste, Auri, Verano, Even, Reva, Solte, Verso - 4 mm glass pane

Estrada - 4 mm glass, 16 mm flat MDF panel, undercut

profile of 19 mm MDF board (Scala B, Piano 9-12, Elsa B, Nestor, Berge)



profile of 16 mm MDF (Piano 1, 2, 5, 6)

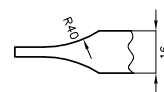

KICK PLATES

Kick plates so called „OKOPNIKI“ it is finishing solution for selected panel door models with straight edge.

We offer door leaf covered with thin 0.6 mm metal sheets made of stainless steel optional bottom and middle panels. It is also possible that both of panels are installed at the same time on the selected door leaf. Height of the panel is 300 mm. Door leaf with kick plates must be filled with perforated chipboard.

There is possibility to order door leaf with bottom panel and ventilation undercut.

NOTE: If you wish to place an order, please contact the Customer Service Department.

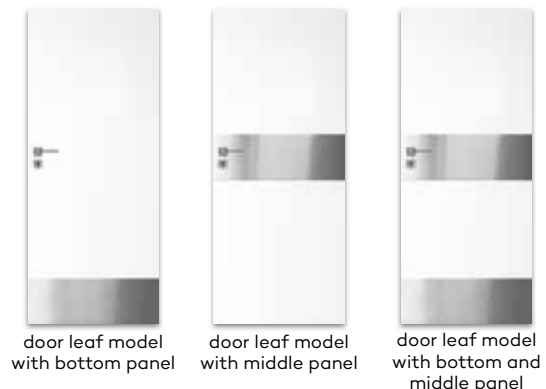

door leaf model with bottom panel

door leaf model with middle panel

door leaf model with bottom and middle panel

TECHNICAL INFORMATIONS

REMAINING TECHNICAL INFORMATIONS:

1. While maintaining the standard dimensions of door leaves and door frames, the gap between the "ready" floor and the lower edge of the door leaf is 8 mm. In order to reduce the above gap, the door frame should be shortened appropriately from the bottom (does not apply to FOLDE and OLIMP).

2. Note! Prior to the purchase and assembly of construction woodwork, check whether the selected type of joinery meet technical requirements of the project and technical drawings, it is particularly necessary to make sure that the construction of walls and ceilings allows for the mounting of construction woodwork of weight specified in the table below:

	door leaf			Door frames		other products	
	interior	entrance	fire-resistance	adjustable	fixed	Adjustable tunnel	Sliding system
Max weight	50 kg*	50 kg*	105 kg*	40 kg	20 kg	40 kg	20 kg

* max weight of single leaf door

3. Door leaf is wrapped in shrink film and the edges are additionally protected with Styrofoam or cardboard inserts.

4. The price of the door leaves does not include the handle, backplates and cylinder insert (except for SCALA A and B collections in rebated and non-rebated option in DRE-Cell veneer and 3D foil, ELSA collection in rebated and non-rebated option in DRE-Cell veneer and 3D foil, and BINI-TO collection in rebated and non-rebated option painted with acrylic varnish).

5. It is possible to purchase doors and door frames CENTRA (in this option there is no sockets for the lock and hinges - option is not available for fire doors, ENTER/SOLID, ENTER ACOUSTIC, SOLID RC2, FORCA B, Sara Eco 2, FOLDE) at a price of a similar product equipped with hardware and pre-milled sockets. CENTRA door frames come with door seal. Set does not include hardware.

6. Under the current regulations, doors to the bathroom, wash room and a separate toilets must be opened to the outwards have width of at least 0,8 meter and height of 2 meter and also have on the bottom part openings with their total surface not smaller than 0,022 m², in order to fulfill correct air circulation. Door ventilation surface is the sum of the available ventilation components: ventilation grille (ensures the ventilation surface of 0,022 m² in all widths of doors) or ventilation undercut or ventilation sleeves, and the surface of the ground clearance between door leaf and the floor.

Ensuring ventilation surface for rebated doors**

Symbol of door leaf dimension	doors with ventilation sleeves		doors with ventilation undercut	
	ventilation surface of sleeves and the clearance 8 mm [m ²]	required clearance to meet ventilation requirements [in mm]	ventilation surface of the undercut and the clearance 8 mm [m ²]	required clearance to meet ventilation requirements [in mm]
"100"	0,011	19*	0,033	0
"90"	0,010	21*	0,029	1
"80"	0,009	24*	0,025	4
"70"	0,008	28*	0,021	14*
"60"	0,007	33*	0,018	35*

Ensuring ventilation surface for Sara Eco 2 doors and all non-rebated doors

Symbol of door leaf dimension	doors with ventilation sleeves		doors with ventilation undercut	
	ventilation surface of sleeves and the clearance 8 mm [m ²]	required clearance to meet ventilation requirements [in mm]	ventilation surface of the undercut and the clearance 8 mm [m ²]	required clearance to meet ventilation requirements [in mm]
"100"	0,0112	19*	0,033	0
"90"	0,0104	21*	0,029	1
"80"	0,0096	23*	0,025	4
"70"	0,0082	27*	0,021	12*
"60"	0,0074	32*	0,018	31*

The above - stated required clearance height of the space under the door assures total ventilation surface of 0.022 m².

The standard clearance for door leaf is 8mm high.

* it is necessary to increase the clearance to the specified height by shortening door leaf at the bottom (when such a shortening is possible - see**)

** Exceptions that are not included in the table (door leaf that can not be shortened):

- collection Vetro A , D and E - the use of ventilation undercut in the door with a width of "80" - "100" and a standard ground clearance of the door (8 mm) will fulfill ventilation requirements.

- Vetro B collection - does not meet the ventilation requirements.

- Sliding doors - due to the design of the sliding system (distance from the wall/tunnel by 12-14 mm), they meet the ventilation requirement without the need to use additional options.

there is no possibility to shorten double leaf doors and folding doors FOLDE.

simultaneously there can be used only one ventilation solution
ventilation sleeves or ventilation undercut or ventilation grille

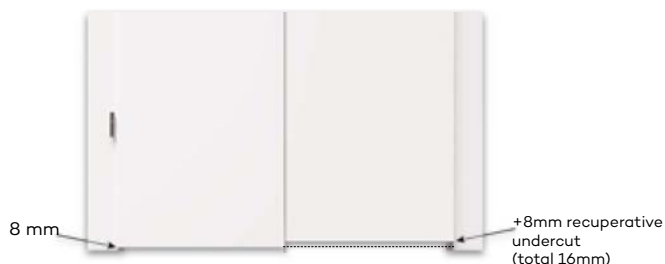
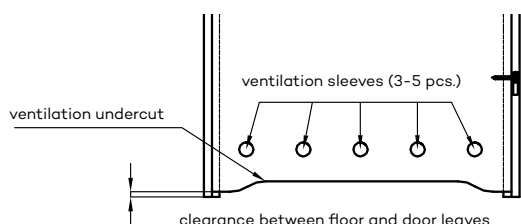





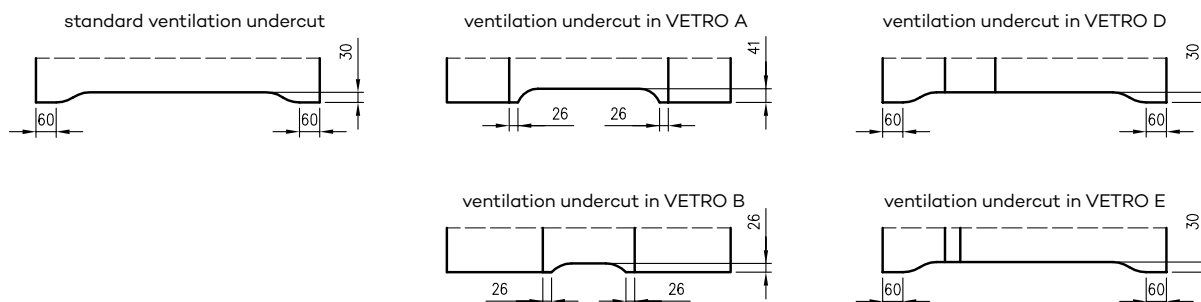























TECHNICAL INFORMATIONS

VENTILATION UNDERCUT



EXPLANATIONS:

- | | |
|---|--|
|  panel doors , DRE - Cell veneer |  PROFI panel construction doors |
|  frame construction doors, DRE - Cell veneer |  panel doors Sara Eco 2 |
|  entrance doors, DRE - Cell veneer |  smoke-proof technical doors |
|  panel doors, 3D veneer |  fire resistant technical doors |
|  frame construction doors , 3D veneer |  anti-burglary doors |
|  entrance doors, 3D veneer |  panel construction doors, lacquered |
|  panel doors, Finish foil |  panel construction doors, synchronous laminate |
|  frame construction doors, Finish veneer |  frame construction doors, synchronous laminate |
|  panel doors, painted |  frame construction doors, glossy |
|  frame construction doors, painted |  panel construction doors, glossy |
|  panel doors, laminate CPL |  frame construction doors, standard matt |
|  entrance doors, laminate CPL |  panel construction doors, standard matt |
|  technical doors, laminate CPL |  frame construction doors, xtreme matt |
|  glass doors |  panel construction doors, xtreme matt |

Presented prices of the door leaves doesnt include prices of the door frames and door handles.

The price list is valid from **03/02/2025**.

Producer provides 24 months of warranty for door leaves and door frames.

pictures and visualisations used in the catalog present door leaf in the width of 80 cm (it doesnt refer to side panels). In the case of other door leaf widths, the proportions of the placement of the design of the collection, glazing, frames, millings, graphics will change.

More technical informations and informations referred to assembly process are available in product guarantee card.

This product catalogue shall not constitute an offer under the regulations of the Civil Code and is published only for information purposes. Information provided in this catalogue was up-to-date on the day the catalogue was published. Due to the company policy of constant development DRE reserves the right to introduce (without prior notice) of changes to technical parameters, equipment, extended warranty conditions and product specification. The actual colours may vary from the colours printed in this catalogue. We reserve the right to errors in print.

Technical approvals:

National Technical Assessment ITB-KOT-2019/0860 edition 2 (sliding system)

National Technical Assessment ITB-KOT-2018/0633 release 2 (FORCA, ATHOS fire doors)

National Technical Assessment ITB-KOT-2022/2051, edition 1 (glass door)

National Technical Assessment ITB-KOT-2021/1945 edition 1 (folding and sliding glass doors)

National Technical Assessment ITB-KOT-2017/0011 3rd edition (ENTER/SOLID/SOLID RC2)

National Technical Assessment ITB-KOT-2018/0407 edition 2 (OLIMP)

PN-EN 14351-2: 2018-E12 (interior doors)

National Technical Assessment ITB-KOT-2019/0805 edition 2 (steel door frames)

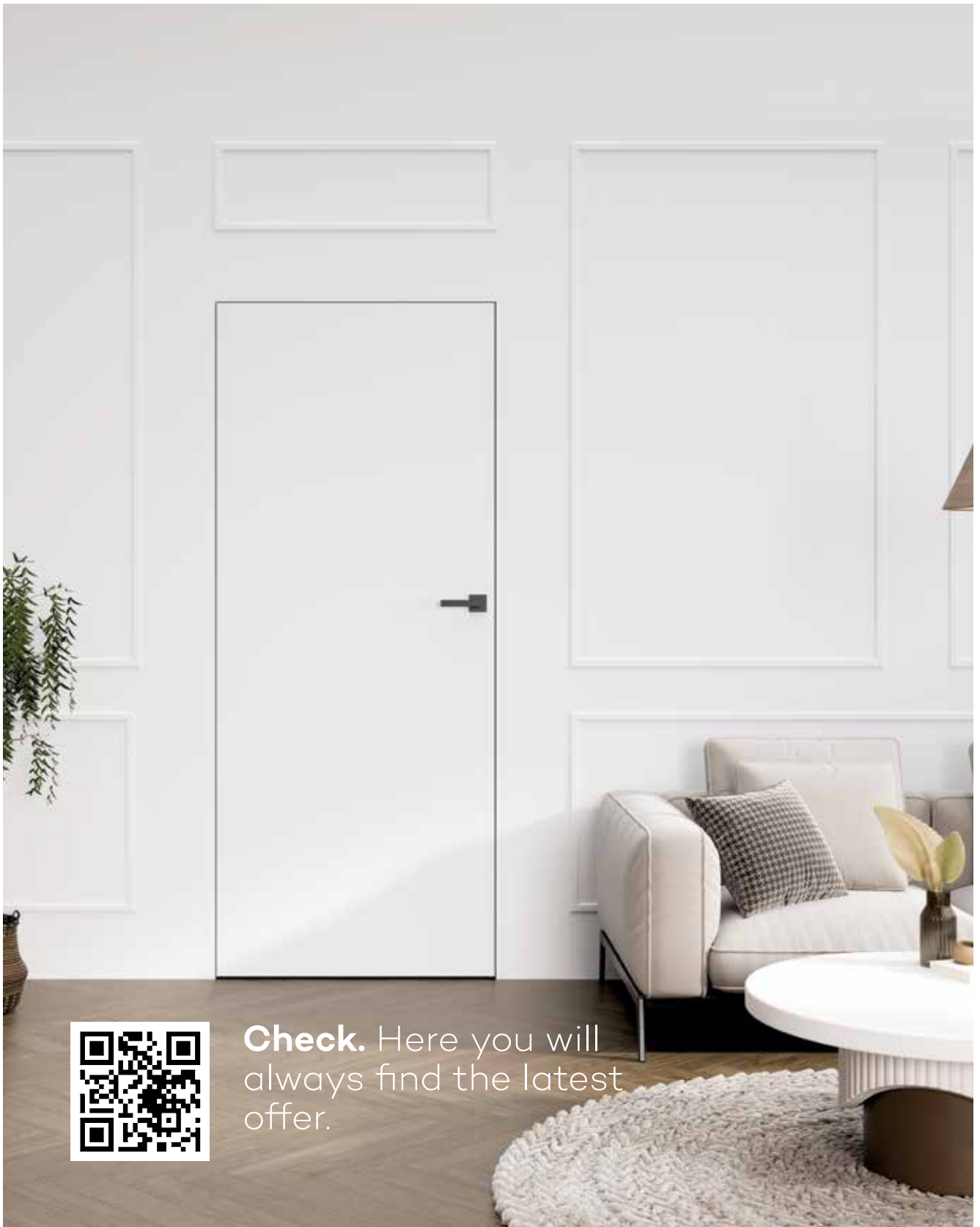

Check. Here you will
always find the latest
offer.

82-300 Elbląg - Gronowo Górne, ul. Nefrytowa 4
Headquarters: phone 55 236 42 58
Customer service department: phone 55 236 42 43 to 48
Marketing department: phone 55 236 42 40
working hours: 8:00 - 16:00
e-mail: dre@dre.pl

DRE

www.dre.pl